

# End clamp - CLIPFIX 35

3022218

<https://www.phoenixcontact.com/de/produkte/3022218>



Please be informed that the data shown in this PDF document is generated from our Online Catalog. Please find the complete data in the user documentation. Our General Terms of Use for Downloads are valid.

---

Quick mounting end clamp for NS 35/7,5 DIN rail or NS 35/15 DIN rail, with marking option, width: 9.5 mm, color: gray



---

## Your advantages

- Large-surface labeling
- Design width of just 9.5 mm
- Phoenix Contact has engineered its CLIPFIX end brackets to maintain a secure grip on the various DIN rail systems

# End clamp - CLIPFIX 35

3022218

<https://www.phoenixcontact.com/de/produkte/3022218>



## Commercial Data

Item number	3022218
Packing unit	50 pc
Minimum order quantity	50 pc
Sales Key	B1 - Markierung Montage
Product Key	BE7111
Catalog Page	Page 538 (C-3-2019)
GTIN	4017918156541
Weight per Piece (including packing)	5,29 g
Weight per Piece (excluding packing)	5,1 g
Customs tariff number	39269097
Country of origin	PL

# End clamp - CLIPFIX 35

3022218

<https://www.phoenixcontact.com/de/produkte/3022218>

## Technical Data

### Product properties

Product type	End block
--------------	-----------

### Dimensions

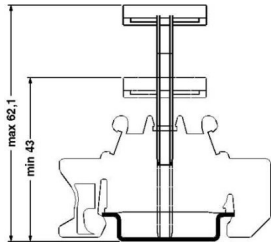
Dimensional drawing	
Width	9.5 mm
Height NS 35/7,5	35.5 mm
Length	55.6 mm

### Material specifications

Color	gray
Material	PA
Flammability rating according to UL 94	V2
Static insulating material application in cold	-60 °C
Temperature index of insulation material (DIN EN 60216-1 (VDE 0304-21))	125 °C
Relative insulation material temperature index (Elec., UL 746 B)	125 °C
Fire protection for rail vehicles (DIN EN 45545-2) R22	HL 1 - HL 2
Fire protection for rail vehicles (DIN EN 45545-2) R23	HL 1 - HL 2
Fire protection for rail vehicles (DIN EN 45545-2) R24	HL 1 - HL 2

### Environmental and real-life conditions

#### Ambient conditions

Ambient temperature (operation)	-60 °C ... 105 °C (max. short-term operating temperature RTI Elec.)
Ambient temperature (storage/transport)	-25 °C ... 60 °C (for a short time, not exceeding 24 h, -60 °C to +70 °C)
Ambient temperature (assembly)	-5 °C ... 70 °C
Ambient temperature (actuation)	-5 °C ... 70 °C
Permissible humidity (storage/transport)	30 % ... 70 %

### Mounting

Mounting type	NS 35/7,5
	NS 35/15

# End clamp - CLIPFIX 35

3022218

<https://www.phoenixcontact.com/de/produkte/3022218>



## Drawings

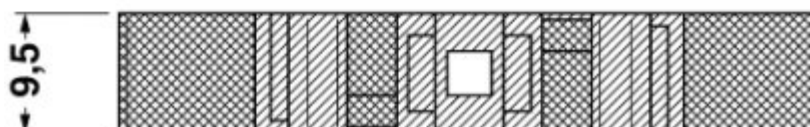
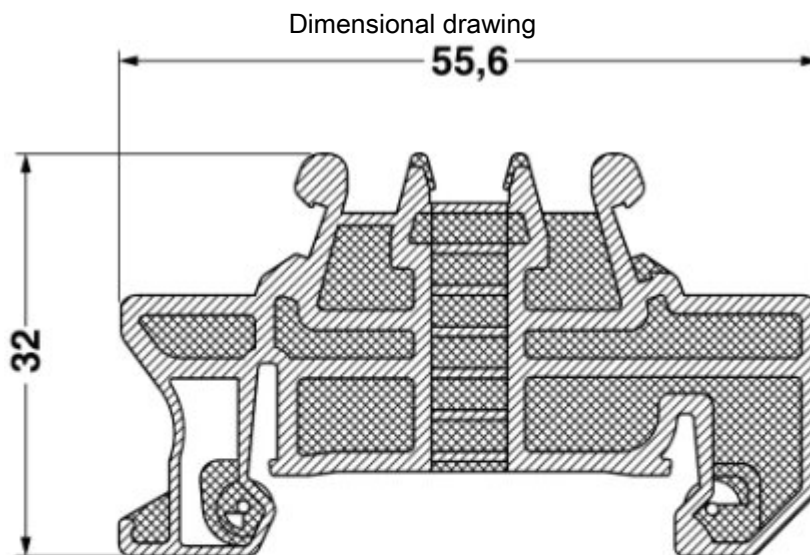
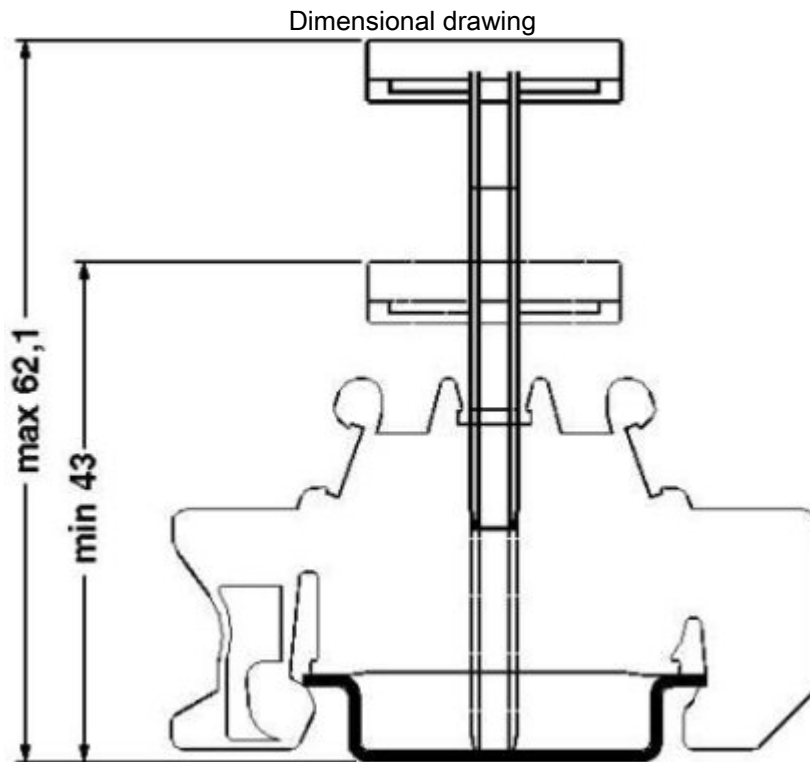

# End clamp - CLIPFIX 35

3022218

<https://www.phoenixcontact.com/de/produkte/3022218>



## Classifications

### ECLASS

ECLASS-9.0	27141135
ECLASS-10.0.1	27141135
ECLASS-11.0	27141135

### ETIM

ETIM 8.0	EC001041
----------	----------

### UNSPSC

UNSPSC 21.0	39121400
-------------	----------

# End clamp - CLIPFIX 35

3022218

<https://www.phoenixcontact.com/de/produkte/3022218>



## Environmental Product Compliance

China RoHS	Environmentally friendly use period: unlimited = EFUP-e
	No hazardous substances above threshold values

# End clamp - CLIPFIX 35

3022218

<https://www.phoenixcontact.com/de/produkte/3022218>



## Accessories

### Terminal strip marker carrier

Terminal strip marker carrier - KLM 2 - 0807575

<https://www.phoenixcontact.com/de/produkte/0807575>

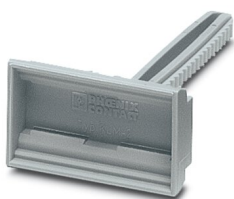

Terminal strip marker carrier, gray, unlabeled, mounting type: plug in, lettering field size: 20 mm x 8 mm

---

### DIN rail perforated

DIN rail perforated - NS 35/ 7,5 PERF 2000MM - 0801733

<https://www.phoenixcontact.com/de/produkte/0801733>



DIN rail perforated, acc. to EN 60715, material: Steel, galvanized, passivated with a thick layer, Standard profile, color: silver, Pack of 25 (50 m)

# End clamp - CLIPFIX 35

3022218

<https://www.phoenixcontact.com/de/produkte/3022218>



## DIN rail, unperforated

DIN rail, unperforated - NS 35/ 7,5 UNPERF 2000MM - 0801681

<https://www.phoenixcontact.com/de/produkte/0801681>



DIN rail, unperforated, acc. to EN 60715, material: Steel, galvanized, passivated with a thick layer, Standard profile, color: silver, Pack of 25 (50 m)

---

## Terminal strip marker carrier

Terminal strip marker carrier - KLM - 1004306

<https://www.phoenixcontact.com/de/produkte/1004306>

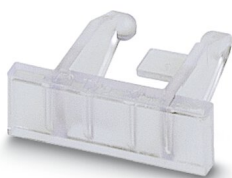

Terminal strip markers, for strip marking, snap onto end bracket E/UK or CLIPFIX 35, lettering field size: 25 x 6 mm



# End clamp - CLIPFIX 35

3022218

<https://www.phoenixcontact.com/de/produkte/3022218>



## DIN rail perforated

DIN rail perforated - NS 35/ 7,5 WH PERF 2000MM - 1204119

<https://www.phoenixcontact.com/de/produkte/1204119>



DIN rail perforated, acc. to EN 60715, material: Steel, Galvanized, white passivated, Standard profile, color: silver, Pack of 25 (50 m)

---

## Terminal strip marker carrier

Terminal strip marker carrier - KLM 3 - 0811969

<https://www.phoenixcontact.com/de/produkte/0811969>



Terminal strip marker carrier, height-adjustable, for end brackets CLIPFIX 15, CLIPFIX 35 and CLIPFIX 35-5, can be labeled with BMK...20 x 8 labels, or directly with the M-PEN or X-PEN

# End clamp - CLIPFIX 35

3022218

<https://www.phoenixcontact.com/de/produkte/3022218>



## DIN rail, unperforated

DIN rail, unperforated - NS 35/ 7,5 WH UNPERF 2000MM-VPE 10 - 1204122

<https://www.phoenixcontact.com/de/produkte/1204122>



DIN rail, unperforated, acc. to EN 60715, material: Steel, Galvanized, white passivated, Standard profile, color: silver, Pack of 10 (20 m)

---

## Terminal strip marker carrier

Terminal strip marker carrier - KLM 3-L - 0814788

<https://www.phoenixcontact.com/de/produkte/0814788>



Terminal strip marker carrier, height-adjustable, for end brackets CLIPFIX 15, CLIPFIX 35 and CLIPFIX 35-5, can be labeled with BMK...20 x 8 labels, or directly with the M-PEN or X-PEN

# End clamp - CLIPFIX 35

3022218

<https://www.phoenixcontact.com/de/produkte/3022218>



## DIN rail, unperforated

DIN rail, unperforated - NS 35/ 7,5 AL UNPERF 2000MM - 0801704

<https://www.phoenixcontact.com/de/produkte/0801704>



DIN rail, unperforated, acc. to EN 60715, material: Aluminum, uncoated, Standard profile, color: silver, Pack of 25 (50 m)

---

## Terminal strip marker carrier

Terminal strip marker carrier - KLM-A - 1004348

<https://www.phoenixcontact.com/de/produkte/1004348>

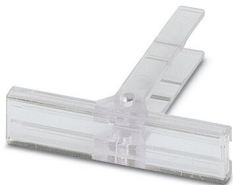

Terminal strip markers, for strip marking, adjustable height, for use with end clamps E/UK, E/NS 35 N or CLIPFIX 35, lettering field size: 44 x 7 mm

# End clamp - CLIPFIX 35

3022218

<https://www.phoenixcontact.com/de/produkte/3022218>



## DIN rail perforated

DIN rail perforated - NS 35/ 7,5 ZN PERF 2000MM - 1206421

<https://www.phoenixcontact.com/de/produkte/1206421>



DIN rail perforated, acc. to EN 60715, material: Steel, galvanized, Standard profile, color: silver, Pack of 25 (50 m)

---

## Terminal strip marker carrier

Terminal strip marker carrier - KLM 1 - 1004319

<https://www.phoenixcontact.com/de/produkte/1004319>

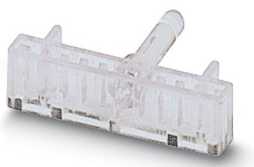

Terminal strip markers, for use with end clamps E/MBKor CLIPFIX 35, lettering field size: 24 x 4 mm

# End clamp - CLIPFIX 35

3022218

<https://www.phoenixcontact.com/de/produkte/3022218>



## DIN rail, unperforated

DIN rail, unperforated - NS 35/ 7,5 ZN UNPERF 2000MM - 1206434

<https://www.phoenixcontact.com/de/produkte/1206434>



DIN rail, unperforated, acc. to EN 60715, material: Steel, galvanized, Standard profile, color: silver, Pack of 25 (50 m)

---

## Terminal strip marker carrier

Terminal strip marker carrier - KLM 4 - 0811970

<https://www.phoenixcontact.com/de/produkte/0811970>

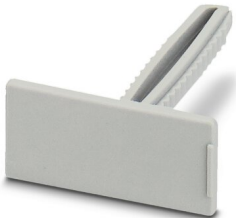

Terminal strip marker carrier, height-adjustable, for end brackets CLIPFIX 15, CLIPFIX 35 and CLIPFIX 35-5, can be labeled with BMK...20 x 8 labels, or directly with the M-PEN or X-PEN

# End clamp - CLIPFIX 35

3022218

<https://www.phoenixcontact.com/de/produkte/3022218>



## DIN rail, unperforated

DIN rail, unperforated - NS 35/ 7,5 CU UNPERF 2000MM-VPE 10 - 0801762

<https://www.phoenixcontact.com/de/produkte/0801762>



DIN rail, unperforated, acc. to EN 60715, material: Copper, uncoated, Standard profile, color: copper-colored, Pack of 10 (20 m)

---

## End cap

End cap - NS 35/ 7,5 CAP - 1206560

<https://www.phoenixcontact.com/de/produkte/1206560>

DIN rail end piece, for DIN rail NS 35/7.5



# End clamp - CLIPFIX 35

3022218

<https://www.phoenixcontact.com/de/produkte/3022218>



## DIN rail perforated

DIN rail perforated - NS 35/15 PERF 2000MM - 1201730

<https://www.phoenixcontact.com/de/produkte/1201730>



DIN rail perforated, similar to EN 60715, material: Steel, galvanized, passivated with a thick layer, Standard profile, color: silver, Pack of 25 (50 m)

---

## DIN rail, unperforated

DIN rail, unperforated - NS 35/15 UNPERF 2000MM - 1201714

<https://www.phoenixcontact.com/de/produkte/1201714>



DIN rail, unperforated, similar to EN 60715, material: Steel, galvanized, passivated with a thick layer, Standard profile, color: silver, Pack of 25 (50 m)

# End clamp - CLIPFIX 35

3022218

<https://www.phoenixcontact.com/de/produkte/3022218>



## DIN rail perforated

DIN rail perforated - NS 35/15 WH PERF 2000MM - 0806602

<https://www.phoenixcontact.com/de/produkte/0806602>



DIN rail perforated, similar to EN 60715, material: Steel, Galvanized, white passivated, Standard profile, color: white, Pack of 25 (50 m)

---

## DIN rail, unperforated

DIN rail, unperforated - NS 35/15 WH UNPERF 2000MM-VPE 10 - 1204135

<https://www.phoenixcontact.com/de/produkte/1204135>



DIN rail, unperforated, similar to EN 60715, material: Steel, Galvanized, white passivated, Standard profile, color: silver, Pack of 10 (20 m)



# End clamp - CLIPFIX 35

3022218

<https://www.phoenixcontact.com/de/produkte/3022218>



## DIN rail, unperforated

DIN rail, unperforated - NS 35/15 AL UNPERF 2000MM - 1201756

<https://www.phoenixcontact.com/de/produkte/1201756>



DIN rail, unperforated, similar to EN 60715, material: Aluminum, uncoated, Standard profile, color: silver

---

## DIN rail perforated

DIN rail perforated - NS 35/15 ZN PERF 2000MM - 1206599

<https://www.phoenixcontact.com/de/produkte/1206599>



DIN rail perforated, similar to EN 60715, material: Steel, galvanized, Standard profile, color: silver, Pack of 25 (50 m)

# End clamp - CLIPFIX 35

3022218

<https://www.phoenixcontact.com/de/produkte/3022218>



## DIN rail, unperforated

DIN rail, unperforated - NS 35/15 ZN UNPERF 2000MM - 1206586

<https://www.phoenixcontact.com/de/produkte/1206586>



DIN rail, unperforated, similar to EN 60715, material: Steel, galvanized, Standard profile, color: silver, Pack of 25 (50 m)

---

## DIN rail, unperforated

DIN rail, unperforated - NS 35/15 CU UNPERF 2000MM-VPE 10 - 1201895

<https://www.phoenixcontact.com/de/produkte/1201895>



DIN rail, unperforated, similar to EN 60715, material: Copper, uncoated, Standard profile, color: copper-colored, Pack of 10 (20 m)

# End clamp - CLIPFIX 35

3022218

<https://www.phoenixcontact.com/de/produkte/3022218>

## End cap

End cap - NS 35/15 CAP - 1206573

<https://www.phoenixcontact.com/de/produkte/1206573>

DIN rail end piece, for DIN rail NS 35/15



---

## DIN rail, unperforated

DIN rail, unperforated - NS 35/15-2,3 UNPERF 2000MM-VPE 10 - 1201798

<https://www.phoenixcontact.com/de/produkte/1201798>



DIN rail, unperforated, acc. to EN 60715, material: Steel, galvanized, passivated with a thick layer, Standard profile 2.3 mm, color: silver, Pack of 10 (20 m)

# End clamp - CLIPFIX 35

3022218

<https://www.phoenixcontact.com/de/produkte/3022218>

## Zack marker strip

Zack marker strip - ZB 6:UNBEDRUCKT - 1051003

<https://www.phoenixcontact.com/de/produkte/1051003>



Zack marker strip, Strip, white, unlabeled, can be labeled with: PLOTMARK, CMS-P1-PLOTTER, mounting type: snapped, for terminal block width: 6.2 mm, lettering field size: 6.15 x 10.5 mm, Number of individual labels: 10

---

## Zack marker strip

Zack marker strip - ZB 6 CUS - 0824992

<https://www.phoenixcontact.com/de/produkte/0824992>



Zack marker strip, can be ordered: Strip, white, labeled according to customer specifications, mounting type: snap into tall marker groove, for terminal block width: 6.2 mm, lettering field size: 6.15 x 10.5 mm, Number of individual labels: 10

# End clamp - CLIPFIX 35

3022218

<https://www.phoenixcontact.com/de/produkte/3022218>



## Zack marker strip

Zack marker strip - ZB 6,LGS:FORTL.ZAHLEN - 1051016

<https://www.phoenixcontact.com/de/produkte/1051016>



Zack marker strip, Strip, white, labeled, can be labeled with: CMS-P1-PLOTTER, printed horizontally: consecutive numbers 1 ... 10, 11 ... 20, etc. up to 491 ... 500, mounting type: snapped, for terminal block width: 6.2 mm, lettering field size: 6. 15 x 10.5 mm, Number of individual labels: 10

---

## Zack marker strip

Zack marker strip - ZB 6,QR:FORTL.ZAHLEN - 1051029

<https://www.phoenixcontact.com/de/produkte/1051029>

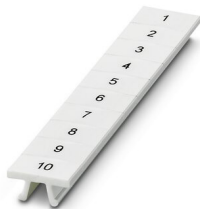

Zack marker strip, Strip, white, labeled, can be labeled with: CMS-P1-PLOTTER, Printed vertically: consecutive numbers 1 ... 10, 11 ... 20, etc. up to 491 ... 500, mounting type: snapped, for terminal block width: 6.2 mm, lettering field size: 6. 15 x 10.5 mm, Number of individual labels: 10

# End clamp - CLIPFIX 35

3022218

<https://www.phoenixcontact.com/de/produkte/3022218>



## Zack marker strip

Zack marker strip - ZB 6,LGS:GLEICHE ZAHLEN - 1051032

<https://www.phoenixcontact.com/de/produkte/1051032>



Zack marker strip, Strip, white, labeled, can be labeled with: CMS-P1-PLOTTER, printed horizontally: Identical numbers 1 or 2, etc. up to 100, mounting type: snapped, for terminal block width: 6.2 mm, lettering field size: 6.15 x 10.5 mm, Number of individual labels: 10

---

## Marker for terminal blocks

Marker for terminal blocks - ZB 6,LGS:L1-N,PE - 1051414

<https://www.phoenixcontact.com/de/produkte/1051414>



Marker for terminal blocks, Strip, white, labeled, can be labeled with: CMS-P1-PLOTTER, horizontal: L1, L2, L3, N, PE, L1, L2, L3, N, PE, mounting type: snapped, for terminal block width: 6.2 mm, lettering field size: 6.15 x 10.5 mm, Number of individual labels: 10

# End clamp - CLIPFIX 35

3022218

<https://www.phoenixcontact.com/de/produkte/3022218>



## Marker for terminal blocks

Marker for terminal blocks - ZB 6,LGS:U-N - 1051430

<https://www.phoenixcontact.com/de/produkte/1051430>



Marker for terminal blocks, Strip, white, labeled, can be labeled with: CMS-P1-PLOTTER, printed horizontally: U, V, W, N, GND, U, V, W, N, GND, mounting type: snapped, for terminal block width: 6.2 mm, lettering field size: 6.15 x 10.5 mm, Number of individual labels: 10

---

## Marker for terminal blocks

Marker for terminal blocks - UC-TM 6 - 0818085

<https://www.phoenixcontact.com/de/produkte/0818085>



Marker for terminal blocks, Sheet, white, unlabeled, can be labeled with: BLUEMARK ID COLOR, BLUEMARK ID, BLUEMARK CLED, PLOTMARK, CMS-P1-PLOTTER, mounting type: snapped, for terminal block width: 6.2 mm, lettering field size: 5.6 x 10.5 mm, Number of individual labels: 80

# End clamp - CLIPFIX 35

3022218

<https://www.phoenixcontact.com/de/produkte/3022218>



## Marker for terminal blocks

Marker for terminal blocks - UC-TM 6 CUS - 0824589

<https://www.phoenixcontact.com/de/produkte/0824589>



Marker for terminal blocks, can be ordered: by sheet, white, labeled according to customer specifications, mounting type: snap into tall marker groove, for terminal block width: 6.2 mm, lettering field size: 5.6 x 10.5 mm, Number of individual labels: 80

---

## Marker for terminal blocks

Marker for terminal blocks - UCT-TM 6 - 0828736

<https://www.phoenixcontact.com/de/produkte/0828736>



Marker for terminal blocks, Sheet, white, unlabeled, can be labeled with: TOPMARK NEO, TOPMARK LASER, BLUEMARK ID COLOR, BLUEMARK ID, BLUEMARK CLED, THERMOMARK PRIME, THERMOMARK CARD 2.0, THERMOMARK CARD, mounting type: snapped, for terminal block width: 6.2 mm, lettering field size: 5.6 x 10.5 mm, Number of individual labels: 60



# End clamp - CLIPFIX 35

3022218

<https://www.phoenixcontact.com/de/produkte/3022218>



## Marker for terminal blocks

Marker for terminal blocks - UCT-TM 6 CUS - 0829602

<https://www.phoenixcontact.com/de/produkte/0829602>



Marker for terminal blocks, can be ordered: by sheet, white, labeled according to customer specifications, mounting type: snap into tall marker groove, for terminal block width: 6.2 mm, lettering field size: 5.6 x 10.5 mm, Number of individual labels: 60

---

## Zack Marker strip, flat

Zack Marker strip, flat - ZBF 6:UNBEDRUCKT - 0808710

<https://www.phoenixcontact.com/de/produkte/0808710>



Zack Marker strip, flat, Strip, white, unlabeled, can be labeled with: PLOTMARK, CMS-P1-PLOTTER, mounting type: snapped, for terminal block width: 6.2 mm, lettering field size: 5.15 x 6.15 mm, Number of individual labels: 10

# End clamp - CLIPFIX 35

3022218

<https://www.phoenixcontact.com/de/produkte/3022218>



## Zack Marker strip, flat

Zack Marker strip, flat - ZBF 6 CUS - 0825027

<https://www.phoenixcontact.com/de/produkte/0825027>



Zack Marker strip, flat, Strip, can be ordered: Strip, white, labeled according to customer specifications, mounting type: snap into flat marker groove, for terminal block width: 6.2 mm, lettering field size: 5.15 x 6.15 mm, Number of individual labels: 10

---

## Marker for terminal blocks

Marker for terminal blocks - UC-TMF 6 - 0818140

<https://www.phoenixcontact.com/de/produkte/0818140>



Marker for terminal blocks, Sheet, white, unlabeled, can be labeled with: BLUEMARK ID COLOR, BLUEMARK ID, BLUEMARK CLED, PLOTMARK, CMS-P1-PLOTTER, mounting type: snapped, for terminal block width: 6.2 mm, lettering field size: 5.6 x 5.1 mm, Number of individual labels: 80

# End clamp - CLIPFIX 35

3022218

<https://www.phoenixcontact.com/de/produkte/3022218>



## Marker for terminal blocks

Marker for terminal blocks - UC-TMF 6 CUS - 0824646

<https://www.phoenixcontact.com/de/produkte/0824646>



Marker for terminal blocks, can be ordered: by sheet, white, labeled according to customer specifications, mounting type: snap into flat marker groove, for terminal block width: 6.2 mm, lettering field size: 5.6 x 5.1 mm, Number of individual labels: 80

---

## Marker for terminal blocks

Marker for terminal blocks - UCT-TMF 6 - 0828746

<https://www.phoenixcontact.com/de/produkte/0828746>



Marker for terminal blocks, Sheet, white, unlabeled, can be labeled with: TOPMARK NEO, TOPMARK LASER, BLUEMARK ID COLOR, BLUEMARK ID, BLUEMARK CLED, THERMOMARK PRIME, THERMOMARK CARD 2.0, THERMOMARK CARD, mounting type: snapped, for terminal block width: 6.2 mm, lettering field size: 5.4 x 4.7 mm, Number of individual labels: 60

# End clamp - CLIPFIX 35

3022218

<https://www.phoenixcontact.com/de/produkte/3022218>



## Marker for terminal blocks

Marker for terminal blocks - UCT-TMF 6 CUS - 0829665

<https://www.phoenixcontact.com/de/produkte/0829665>



Marker for terminal blocks, can be ordered: by sheet, white, labeled according to customer specifications, mounting type: snap into flat marker groove, for terminal block width: 6.2 mm, lettering field size: 5.4 x 4.7 mm, Number of individual labels: 60

---

## Zack Marker strip, flat

Zack Marker strip, flat - ZBF 6,LGS:FORTL.ZAHLEN - 0808749

<https://www.phoenixcontact.com/de/produkte/0808749>



Zack Marker strip, flat, Strip, white, labeled, printed horizontally: consecutive numbers 1 ... 10, 11 ... 20, etc. up to 91 ... 100, mounting type: snapped, for terminal block width: 6.2 mm, lettering field size: 5.15 x 6.15 mm, Number of individual labels: 10

# End clamp - CLIPFIX 35

3022218

<https://www.phoenixcontact.com/de/produkte/3022218>



## Zack Marker strip, flat

Zack Marker strip, flat - ZBF 6,QR:FORTL.ZAHLEN - 0808765

<https://www.phoenixcontact.com/de/produkte/0808765>



Zack Marker strip, flat, Strip, white, labeled, Printed vertically: consecutive numbers 1 ... 10, 11 ... 20, etc. up to 91 ... 100, mounting type: snapped, for terminal block width: 6.2 mm, lettering field size: 5.15 x 6.15 mm, Number of individual labels: 10

---

## Zack Marker strip, flat

Zack Marker strip, flat - ZBF 6,LGS:GERADE ZAHLEN - 0810834

<https://www.phoenixcontact.com/de/produkte/0810834>



Zack Marker strip, flat, Strip, white, labeled, printed horizontally: consecutive even numbers 2 ... 20, 22 ... 40, etc. up to 82 ... 100, mounting type: snapped, for terminal block width: 6.2 mm, lettering field size: 5.15 x 6.15 mm, Number of individual labels: 10

# End clamp - CLIPFIX 35

3022218

<https://www.phoenixcontact.com/de/produkte/3022218>



## Zack Marker strip, flat

Zack Marker strip, flat - ZBF 6,LGS:UNGERADE ZAHLEN - 0810876

<https://www.phoenixcontact.com/de/produkte/0810876>



Zack Marker strip, flat, Strip, white, labeled, printed horizontally: Odd numbers 1 - 19, 21 - 39, etc. up to 81 - 99, mounting type: snapped, for terminal block width: 6.2 mm, lettering field size: 5.15 x 6.15 mm, Number of individual labels: 10

---

Phoenix Contact 2022 © - all rights reserved

<https://www.phoenixcontact.com>

PHOENIX CONTACT Deutschland GmbH

Flachsmarktstraße 8

D-32825 Blomberg

+49 52 35/3-1 20 00

[info@phoenixcontact.de](mailto:info@phoenixcontact.de)