

PCB connector - PC 4/ 9-STF-7,62

1828317

<https://www.phoenixcontact.com/de/produkte/1828317>

Please be informed that the data shown in this PDF document is generated from our Online Catalog. Please find the complete data in the user documentation. Our General Terms of Use for Downloads are valid.



PCB connector, nominal cross section: 4 mm², color: green, nominal current: 20 A, rated voltage (III/2): 630 V, contact surface: Tin, type of contact: Female connector, number of potentials: 9, number of rows: 1, number of positions: 9, number of connections: 9, product range: PC 4/..-STF, pitch: 7.62 mm, connection method: Screw connection with tension sleeve, screw head form: L Slotted, conductor/PCB connection direction: 0 °, locking clip: - Locking clip, plug-in system: COMBICON PC 4, locking: Screw locking, mounting: Screw flange, type of packaging: packed in cardboard

Your advantages

- Well-known connection principle allows worldwide use
- Low temperature rise, thanks to maximum contact force
- Allows connection of two conductors
- Integrated double steel spring provides additional safety in the event of temperature and power fluctuations
- Screwable flange for superior mechanical stability

PCB connector - PC 4/ 9-STF-7,62



1828317

<https://www.phoenixcontact.com/de/produkte/1828317>

Commercial Data

| | |
|--------------------------------------|---------------------------|
| Item number | 1828317 |
| Packing unit | 50 pc |
| Minimum order quantity | 50 pc |
| Sales Key | E1 - Leiterplattenanschl. |
| Product Key | AADAAD |
| Catalog Page | Page 513 (C-1-2013) |
| GTIN | 4017918050542 |
| Weight per Piece (including packing) | 40,92 g |
| Weight per Piece (excluding packing) | 39,392 g |
| Customs tariff number | 85366990 |
| Country of origin | DE |

1828317

<https://www.phoenixcontact.com/de/produkte/1828317>

Technical Data

Product properties

| | |
|-----------------------|-----------------------|
| Type | Standard |
| Product line | COMBICON Connectors L |
| Product type | PCB plug |
| Number of positions | 9 |
| Pitch | 7.62 mm |
| Number of connections | 9 |
| Number of rows | 1 |
| Mounting flange | Screw flange |
| Number of potentials | 9 |

Electrical properties

| | |
|-----------------------------|--------|
| Nominal current I_N | 20 A |
| Nominal voltage U_N | 630 V |
| Pollution degree | 3 |
| Contact resistance | 0.5 mΩ |
| Rated voltage (III/3) | 400 V |
| Rated surge voltage (III/3) | 6 kV |
| Rated voltage (III/2) | 630 V |
| Rated surge voltage (III/2) | 6 kV |

Connection data

Connection technology

| | |
|-----------------------|-------------------|
| Type | Standard |
| Connector system | COMBICON PC 4 |
| Nominal cross section | 4 mm ² |
| Type of contact | Female connector |

Interlock

| | |
|-----------------|-------------------|
| Locking type | Screw locking |
| Mounting flange | Screw flange |
| Torque | 0.3 Nm ... 0.7 Nm |

Conductor connection

| | |
|---|--|
| Connection method | Screw connection with tension sleeve |
| Conductor/PCB connection direction | 0 ° |
| Conductor cross section solid | 0.2 mm ² ... 4 mm ² |
| Conductor cross section flexible | 0.2 mm ² ... 4 mm ² |
| Conductor cross section AWG | 24 ... 10 |
| Conductor cross section flexible, with ferrule without plastic sleeve | 0.25 mm ² ... 4 mm ² |
| Conductor cross section, flexible, with ferrule, with plastic sleeve | 0.25 mm ² ... 4 mm ² |

PCB connector - PC 4/ 9-STF-7,62

1828317

<https://www.phoenixcontact.com/de/produkte/1828317>

| | |
|---|--|
| 2 conductors with same cross section, solid | 0.2 mm ² ... 2.5 mm ² |
| 2 conductors with same cross section, flexible | 0.2 mm ² ... 1.5 mm ² |
| 2 conductors with same cross section, flexible, with ferrule without plastic sleeve | 0.25 mm ² ... 1.5 mm ² |
| 2 conductors with the same cross section, flexible, with TWIN ferrule with plastic sleeve | 0.5 mm ² ... 2.5 mm ² |
| Cylindrical gauge a x b / diameter | 3.6 mm x 3.1 mm / 3.0 mm |
| Stripping length | 7 mm |
| Torque | 0.5 Nm ... 0.6 Nm |

Material specifications

Material data - contact

| | |
|--|--|
| Note | WEEE/RoHS-compliant, free of whiskers according to IEC 60068-2-82/JEDEC JESD 201 |
| Contact material | Cu alloy |
| Surface characteristics | hot-dip tin-plated |
| Metal surface terminal point (top layer) | Tin (4 - 8 µm Sn) |
| Metal surface contact area (top layer) | Tin (4 - 8 µm Sn) |

Material data - housing

| | |
|---|--------------|
| Housing color | green (6021) |
| Insulating material | PA |
| Insulating material group | I |
| CTI according to IEC 60112 | 600 |
| Flammability rating according to UL 94 | V0 |
| Glow wire flammability index GWFI according to EN 60695-2-12 | 850 |
| Glow wire ignition temperature GWIT according to EN 60695-2-13 | 775 |
| Temperature for the ball pressure test according to EN 60695-10-2 | 125 °C |

Dimensions

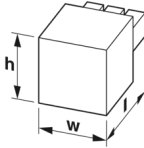
| | |
|---------------------|--|
| Dimensional drawing |  |
| Pitch | 7.62 mm |
| Width [w] | 83.8 mm |
| Height [h] | 18.1 mm |
| Length [l] | 30.7 mm |
| Installed height | 18.1 mm |

Mounting

| | |
|-----------------------|-------------|
| Drive form screw head | Slotted (L) |
|-----------------------|-------------|

PCB connector - PC 4/ 9-STF-7,62



1828317

<https://www.phoenixcontact.com/de/produkte/1828317>

Flange

| | |
|-------------------|-------------------|
| Tightening torque | 0.3 Nm ... 0.7 Nm |
|-------------------|-------------------|

Notes

| | |
|--------------------|--|
| Notes on operation | In accordance with IEC 61984, COMBICON connectors have no switching power (COC). During designated use, they must not be plugged in or disconnected when carrying voltage or under load. |
|--------------------|--|

Mechanical tests

Test for conductor damage and slackening

| | |
|---------------|---------------------|
| Specification | IEC 60999-1:1999-11 |
| Result | Test passed |

Pull-out test

| | |
|---|---|
| Specification | IEC 60999-1:1999-11 |
| Conductor cross section/conductor type/tractive force setpoint/actual value | 0.2 mm ² / solid / > 10 N |
| | 0.2 mm ² / flexible / > 10 N |
| | 4 mm ² / solid / > 60 N |
| | 4 mm ² / flexible / > 60 N |

Insertion and withdrawal forces

| | |
|-------------------------------------|-------------|
| Result | Test passed |
| No. of cycles | 50 |
| Insertion strength per pos. approx. | 8 N |
| Withdraw strength per pos. approx. | 5 N |

Torque test

| | |
|---------------|---------------------|
| Specification | IEC 60999-1:1999-11 |
|---------------|---------------------|

Contact holder in insert

| | |
|---|------------------------|
| Specification | IEC 60512-15-1:2008-05 |
| Contact holder in insert Requirements >20 N | Test passed |

Resistance of inscriptions

| | |
|---------------|------------------------|
| Specification | IEC 60068-2-70:1995-12 |
| Result | Test passed |

Polarization and coding

| | |
|---------------|------------------------|
| Specification | IEC 60512-13-5:2006-02 |
| Result | Test passed |

Visual inspection

| | |
|---------------|-----------------------|
| Specification | IEC 60512-1-1:2002-02 |
| Result | Test passed |

Dimension check

| | |
|---------------|-----------------------|
| Specification | IEC 60512-1-2:2002-02 |
|---------------|-----------------------|

| | |
|--------|-------------|
| Result | Test passed |
|--------|-------------|

Environmental and real-life conditions

Vibration test

| | |
|------------------------|------------------------|
| Specification | IEC 60068-2-6:2007-12 |
| Frequency | 10 - 150 - 10 Hz |
| Sweep speed | 1 octave/min |
| Amplitude | 0.35 mm (10 - 60.1 Hz) |
| Sweep speed | 5g (60.1 - 150 Hz) |
| Test duration per axis | 2.5 h |

Durability test

| | |
|--|-----------------------|
| Specification | IEC 60512-9-1:2010-03 |
| Impulse withstand voltage at sea level | 7.3 kV |
| Contact resistance R ₁ | 0.5 mΩ |
| Contact resistance R ₂ | 0.6 mΩ |
| Insertion/withdrawal cycles | 50 |

Climatic test

| | |
|-----------------------------------|---|
| Specification | ISO 6988:1985-02 |
| Corrosive stress | 0.2 dm ³ SO ₂ on 300 dm ³ /40 °C/1 cycle |
| Thermal stress | 100 °C/168 h |
| Power-frequency withstand voltage | 3.31 kV |

Shocks

| | |
|-----------------|-----------------------------------|
| Specification | IEC 60068-2-27:2008-02 |
| Pulse shape | Half-sine |
| Acceleration | 30g |
| Shock duration | 18 ms |
| Test directions | X-, Y- and Z-axis (pos. and neg.) |

Ambient conditions

| | |
|---|---|
| Ambient temperature (operation) | -40 °C ... 100 °C (dependent on the derating curve) |
| Ambient temperature (storage/transport) | -40 °C ... 70 °C |
| Relative humidity (storage/transport) | 30 % ... 70 % |
| Ambient temperature (assembly) | -5 °C ... 100 °C |

Electrical tests

Thermal test | Test group C

| | |
|----------------------------|-----------------------|
| Specification | IEC 60512-5-1:2002-02 |
| Tested number of positions | 12 |

Insulation resistance

| | |
|--|-----------------------|
| Specification | IEC 60512-3-1:2002-02 |
| Insulation resistance, neighboring positions | > 5 MΩ |

PCB connector - PC 4/ 9-STF-7,62



1828317

<https://www.phoenixcontact.com/de/produkte/1828317>

Air clearances and creepage distances |

| | |
|--|---------------------|
| Specification | IEC 60664-1:2007-04 |
| Insulating material group | I |
| Comparative tracking index (IEC 60112) | CTI 600 |
| Rated insulation voltage (III/3) | 400 V |
| Rated surge voltage (III/3) | 6 kV |
| minimum clearance value - non-homogenous field (III/3) | 5.5 mm |
| minimum creepage distance (III/3) | 5.5 mm |
| Rated insulation voltage (III/2) | 630 V |
| Rated surge voltage (III/2) | 6 kV |
| minimum clearance value - non-homogenous field (III/2) | 5.5 mm |
| minimum creepage distance (III/2) | 5.5 mm |
| Rated insulation voltage (II/2) | 1000 V |
| Rated surge voltage (II/2) | 6 kV |
| minimum clearance value - non-homogenous field (II/2) | 5.5 mm |
| minimum creepage distance (II/2) | 5.5 mm |

Packaging specifications

| | |
|-------------------|---------------------|
| Type of packaging | packed in cardboard |
|-------------------|---------------------|

Drawings

Diagram

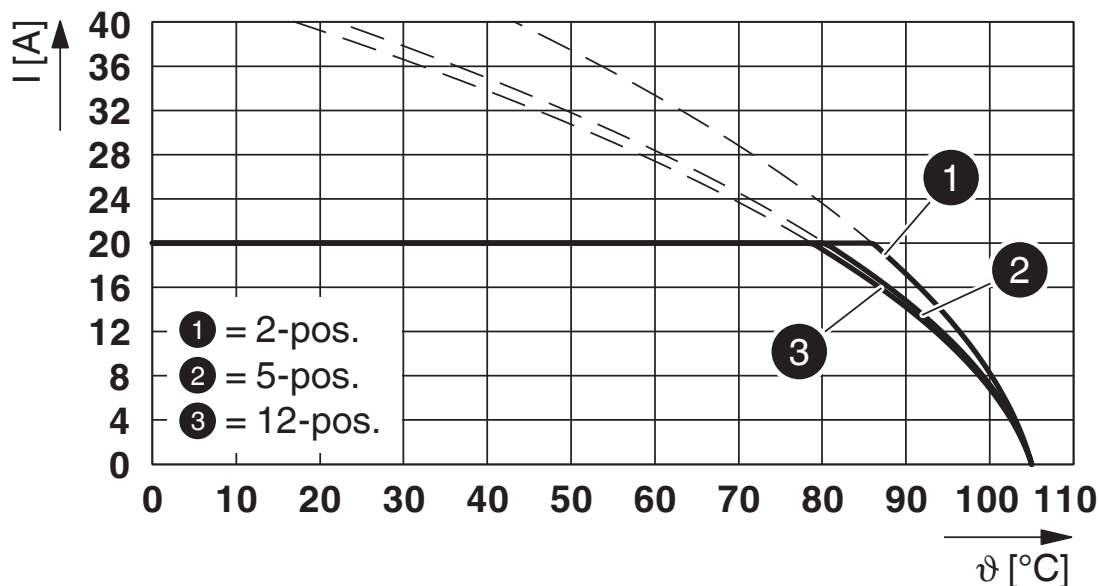

Type: PC 4/...-STF-7,62 with PC 5/...-GF-7,62

Diagram

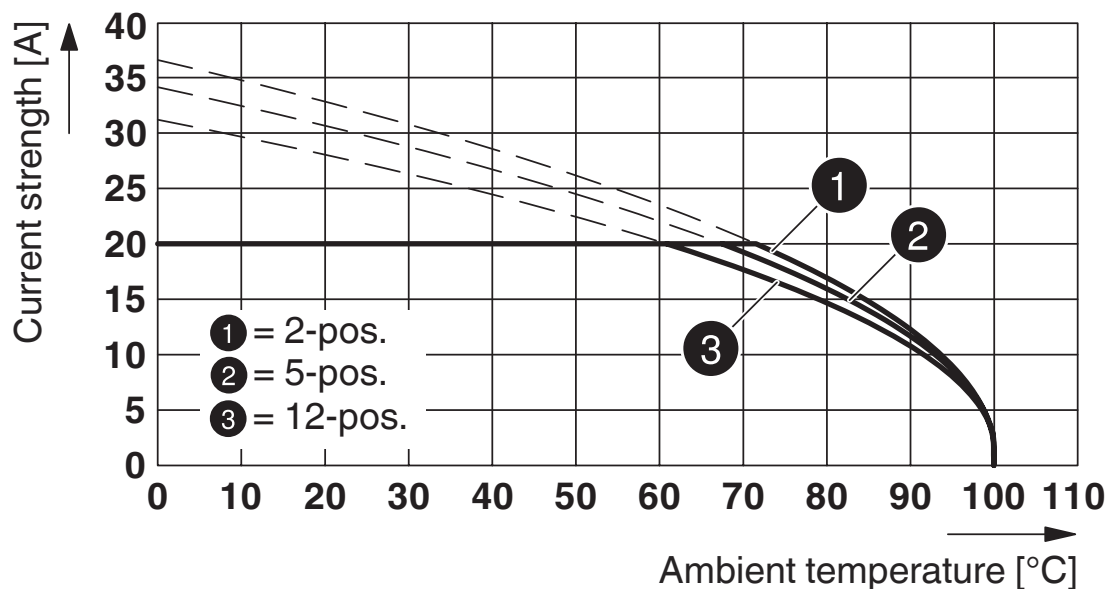

Type: PC 4/...-STF-7,62 with PCV 4/...-G-7,62 and BF-PC 4

PCB connector - PC 4/ 9-STF-7,62

1828317

<https://www.phoenixcontact.com/de/produkte/1828317>

Dimensional drawing

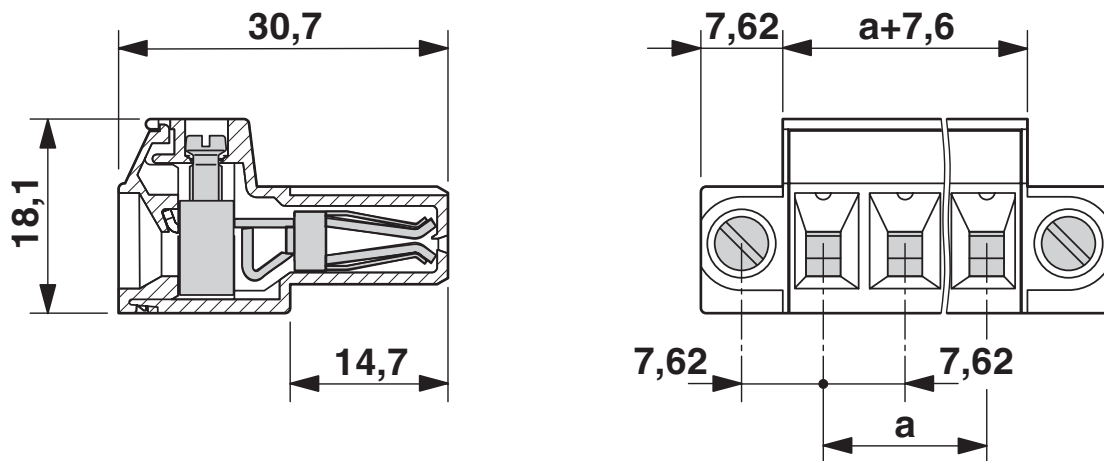

Diagram

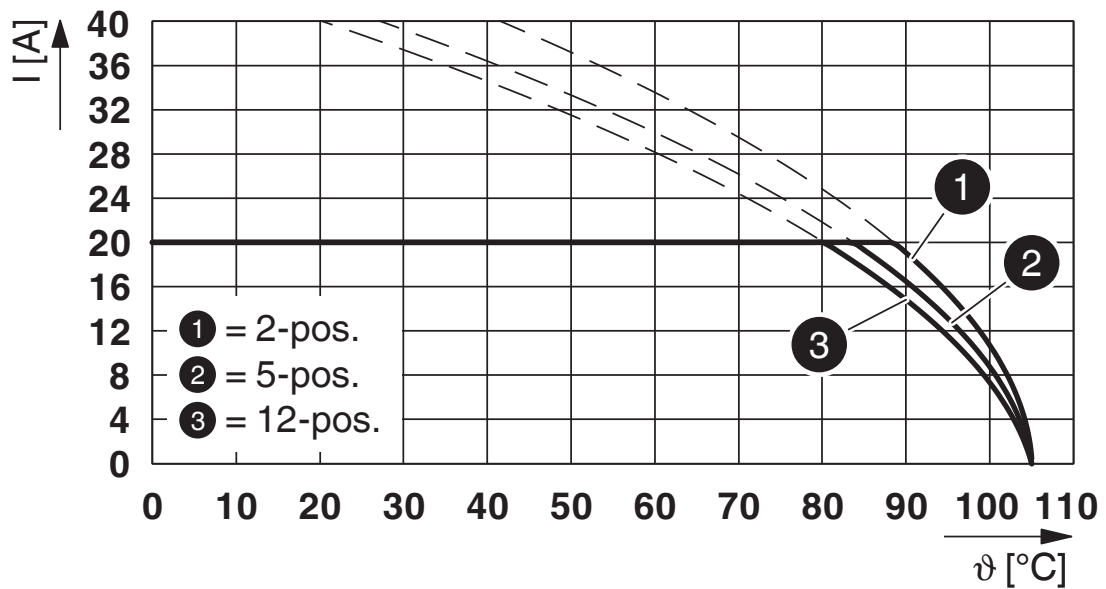

Type: PC 4/...-STF-7,62 with PC 5/...-GFU-7,62

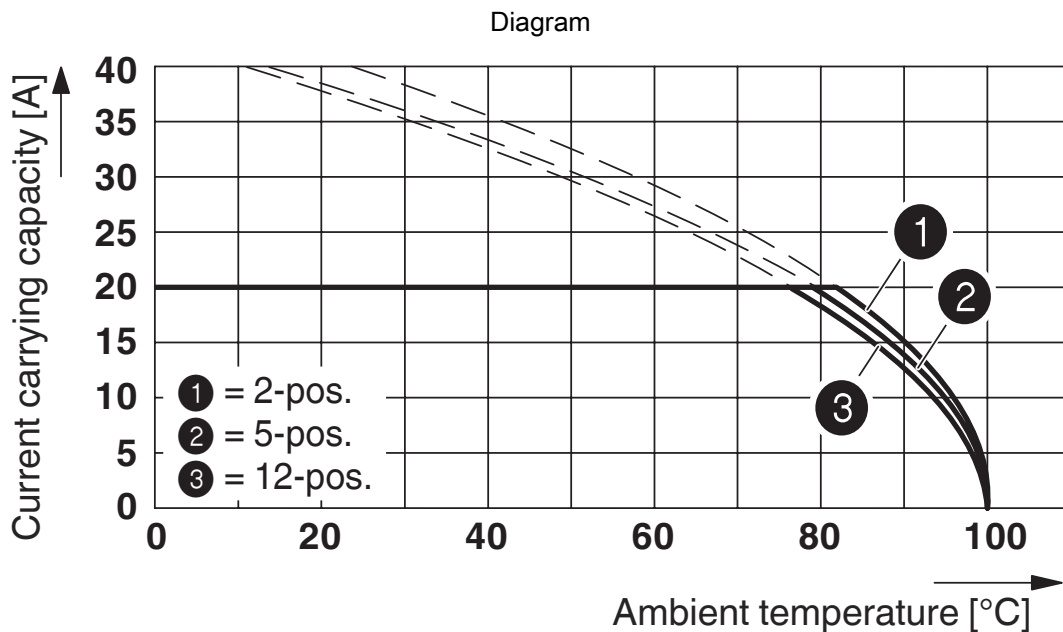

Type: PC 4/...-STF-7,62 with DFK-PC 4/...-GF-7,62

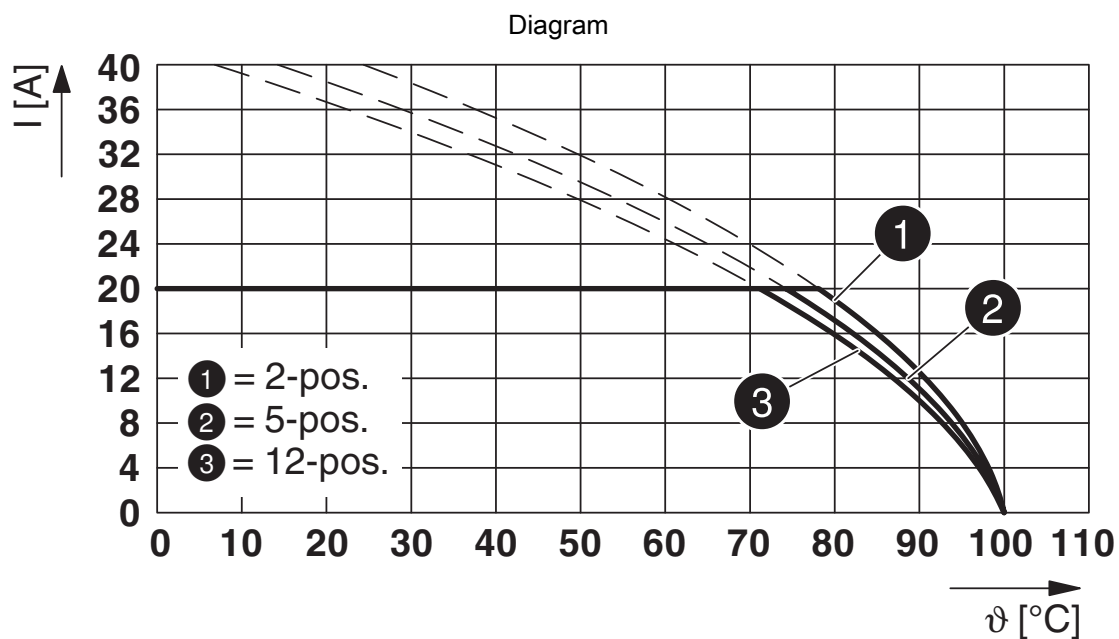

Type: PC 4/...-STF-7,62 with IPC 5/...-STGF-7,62

1828317

<https://www.phoenixcontact.com/de/produkte/1828317>

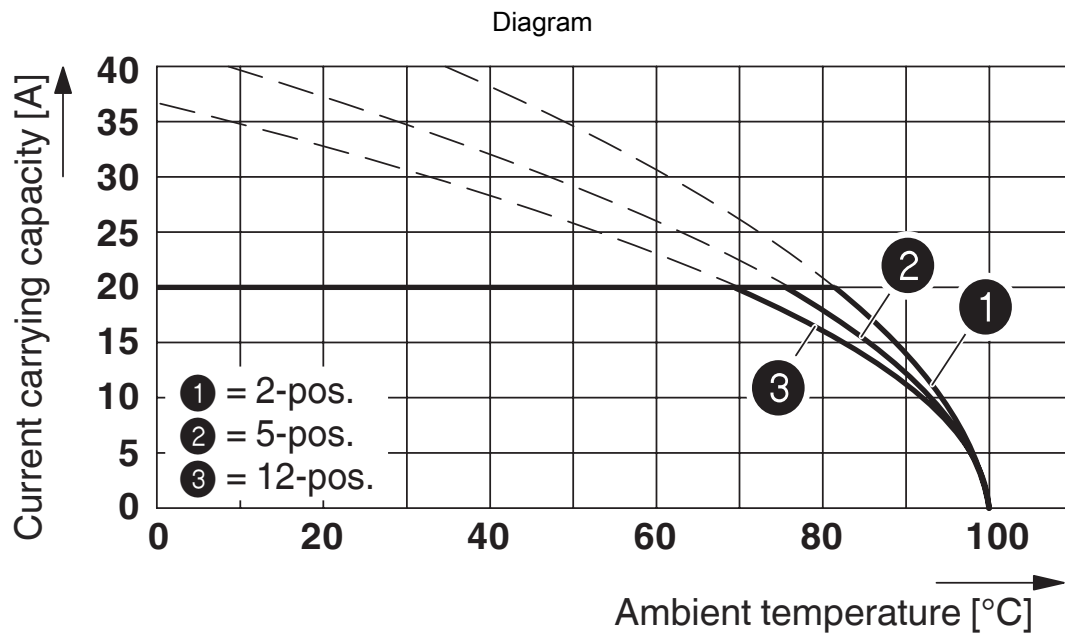

Type: PC 4/...-STF-7,62 with PC 4/...-G-7,62 and BF-PC 4

PCB connector - PC 4/ 9-STF-7,62





1828317

<https://www.phoenixcontact.com/de/produkte/1828317>

Approvals

|  CSA Approval ID: 13631 | | | | |
|--|-----------------------|-----------------------|-------------------|----------------------|
| | Nominal Voltage U_N | Nominal Current I_N | Cross Section AWG | Cross Section mm^2 |
| Use group B | 300 V | 20 A | 28 - 10 | - |
| Use group C | 300 V | 20 A | 28 - 10 | - |

|  EAC Approval ID: B.01687 | | | | |
|--|--|--|--|--|
|--|--|--|--|--|

|  cULus Recognized Approval ID: E60425-19920722 | | | | |
|---|-----------------------|-----------------------|-------------------|----------------------|
| | Nominal Voltage U_N | Nominal Current I_N | Cross Section AWG | Cross Section mm^2 |
| Use group B | 300 V | 30 A | 30 - 10 | - |
| Use group C | 300 V | 30 A | 30 - 10 | - |
| Use group D | 600 V | 5 A | 30 - 10 | - |

|  DNV GL Approval ID: TAE00001EZ | | | | |
|--|--|--|--|--|
|--|--|--|--|--|

|  LR Approval ID: LR21308805TA | | | | |
|--|-----------------------|-----------------------|-------------------|----------------------|
| | Nominal Voltage U_N | Nominal Current I_N | Cross Section AWG | Cross Section mm^2 |
| | | | - | - |

|  BV Approval ID: 35433/B0 BV | | | | |
|---|--|--|--|--|
|---|--|--|--|--|

PCB connector - PC 4/ 9-STF-7,62



1828317

<https://www.phoenixcontact.com/de/produkte/1828317>

Classifications

ECLASS

| | |
|---------------|----------|
| ECLASS-9.0 | 27440309 |
| ECLASS-10.0.1 | 27440309 |
| ECLASS-11.0 | 27460202 |

ETIM

| | |
|----------|----------|
| ETIM 8.0 | EC002638 |
|----------|----------|

UNSPSC

| | |
|-------------|----------|
| UNSPSC 21.0 | 39121400 |
|-------------|----------|

PCB connector - PC 4/ 9-STF-7,62

1828317

<https://www.phoenixcontact.com/de/produkte/1828317>



Environmental Product Compliance

| | |
|------------|---|
| China RoHS | Environmentally friendly use period: unlimited = EFUP-e |
| | No hazardous substances above threshold values |

PCB connector - PC 4/ 9-STF-7,62

1828317

<https://www.phoenixcontact.com/de/produkte/1828317>

Accessories

Coding profile

Coding profile - CP-PC RD - 1701967

<https://www.phoenixcontact.com/de/produkte/1701967>

Coding profile, for plugging into the coding ribs of the plug at a later date, insulating material, color: Red



Marker card

Marker card - SK 7,62/3,8:FORTL.ZAHLEN - 0804549

<https://www.phoenixcontact.com/de/produkte/0804549>

Marker card, white, labeled, horizontal: consecutive numbers 1 ... 10, 11 ... 20, etc. up to 91 ... 100, mounting type: adhesive, for terminal block width: 7.62 mm, lettering field size: 7.62 x 3.8 mm

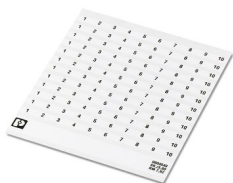

PCB connector - PC 4/ 9-STF-7,62

1828317

<https://www.phoenixcontact.com/de/produkte/1828317>

Screwdriver

Screwdriver - SZS 0,6X3,5 - 1205053

<https://www.phoenixcontact.com/de/produkte/1205053>



Actuation tool, for ST terminal blocks, insulated, also suitable for use as a bladed screwdriver, size: 0.6 x 3.5 x 100 mm, 2-component grip, with non-slip grip

PCB header

PCB header - PCVK 4-7,62-PE - 1876246

<https://www.phoenixcontact.com/de/produkte/1876246>



DIN rail connector, nominal cross section: 4 mm², color: green-yellow, nominal current: 20 A, rated voltage (III/2): 630 V, contact surface: Tin, type of contact: Male connector, number of potentials: 1, number of rows: 1, number of positions: 1, number of connections: 1, product range: PCVK 4-PE, pitch: 7.62 mm, connection method: Screw connection with tension sleeve, conductor/PCB connection direction: 0 °, plug-in system: COMBICON PC 4, locking: without, mounting: without, type of packaging: packed in cardboard

PCB connector - PC 4/ 9-STF-7,62

1828317

<https://www.phoenixcontact.com/de/produkte/1828317>

PCB header

PCB header - PCVK 4-7,62 - 1849998

<https://www.phoenixcontact.com/de/produkte/1849998>



DIN rail connector, nominal cross section: 4 mm², color: green, nominal current: 20 A, rated voltage (III/2): 630 V, contact surface: Tin, type of contact: Male connector, number of potentials: 1, number of rows: 1, number of positions: 1, number of connections: 1, product range: PCVK 4, pitch: 7.62 mm, connection method: Screw connection with tension sleeve, conductor/PCB connection direction: 0 °, plug-in system: COMBICON PC 4, locking: without, mounting: without, type of packaging: packed in cardboard

Feed-through terminal block

Feed-through terminal block - UPCV3K 4-G-7,62 - 1838381

<https://www.phoenixcontact.com/de/produkte/1838381>



Feed-through terminal block, nom. voltage: 800 V, nominal current: 20 A, connection method: Screw/plug-in connection, cross section: 0.2 mm² - 4 mm², mounting type: NS 35/7,5, NS 35/15, NS 32, color: gray

PCB connector - PC 4/ 9-STF-7,62

1828317

<https://www.phoenixcontact.com/de/produkte/1828317>

Feed-through plug

Feed-through plug - DFK-PC 4/ 9-GF-7,62 - 1840625

<https://www.phoenixcontact.com/de/produkte/1840625>

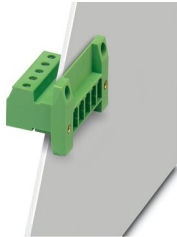

Feed-through connector, nominal cross section: 4 mm², color: green, nominal current: 20 A, rated voltage (III/2): 630 V, contact surface: Tin, type of contact: Male connector, number of potentials: 9, number of rows: 1, number of positions: 9, number of connections: 9, product range: DFK-PC 4/...-GF, pitch: 7.62 mm, connection method: Screw connection with tension sleeve, conductor/PCB connection direction: 0 °, number of solder pins per potential: 1, plug-in system: COMBICON PC 4, Pin connector pattern alignment: Standard, locking: Screw locking, mounting: Threaded flange, type of packaging: packed in cardboard

Phoenix Contact 2022 © - all rights reserved

<https://www.phoenixcontact.com>

PHOENIX CONTACT Deutschland GmbH

Flachsmarktstraße 8

D-32825 Blomberg

+49 52 35/3-1 20 00

info@phoenixcontact.de