

Printed-circuit board connector - FMC 1,5/ 3-ST-3,5



1952270

<https://www.phoenixcontact.com/de/produkte/1952270>

Please be informed that the data shown in this PDF document is generated from our Online Catalog. Please find the complete data in the user documentation. Our General Terms of Use for Downloads are valid.

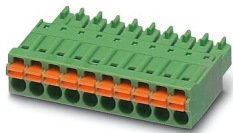

PCB connector, nominal cross section: 1.5 mm², color: green, nominal current: 8 A, rated voltage (III/2): 160 V, contact surface: Tin, type of contact: Female connector, number of potentials: 3, number of rows: 1, number of positions: 3, number of connections: 3, product range: FMC 1,5/..-ST, pitch: 3.5 mm, connection method: Push-in spring connection, conductor/PCB connection direction: 0 °, number of solder pins per potential: 1, plug-in system: COMBICON MC 1,5, locking: without, mounting: without, type of packaging: packed in cardboard

Your advantages

- Time saving push-in connection, tools not required
- Defined contact force ensures that contact remains stable over the long term
- Intuitive use through colour coded actuation lever
- Operation and conductor connection from one direction enable integration into front of device

Printed-circuit board connector - FMC 1,5/ 3-ST-3,5



1952270

<https://www.phoenixcontact.com/de/produkte/1952270>

Commercial Data

Item number	1952270
Packing unit	250 pc
Minimum order quantity	250 pc
Sales Key	E1 - Leiterplattenanschl.
Product Key	AABFAA
Catalog Page	Page 200 (C-1-2013)
GTIN	4017918942861
Weight per Piece (including packing)	1,77 g
Weight per Piece (excluding packing)	1,67 g
Customs tariff number	85366990
Country of origin	DE

1952270

<https://www.phoenixcontact.com/de/produkte/1952270>

Technical Data

Product properties

Type	Standard
Product line	COMBICON Connectors S
Product type	PCB plug
Number of positions	3
Pitch	3.5 mm
Number of connections	3
Number of rows	1
Mounting flange	without
Number of potentials	3

Electrical properties

Nominal current I_N	8 A
Nominal voltage U_N	160 V
Pollution degree	3
Contact resistance	1.5 mΩ
Rated voltage (III/3)	160 V
Rated surge voltage (III/3)	2.5 kV
Rated voltage (III/2)	160 V
Rated surge voltage (III/2)	2.5 kV

Connection data

Connection technology

Type	Standard
Connector system	COMBICON MC 1,5
Nominal cross section	1.5 mm ²
Type of contact	Female connector

Interlock

Locking type	without
Mounting flange	without

Conductor connection

Connection method	Push-in spring connection
Conductor/PCB connection direction	0 °
Conductor cross section solid	0.2 mm ² ... 1.5 mm ²
Conductor cross section flexible	0.2 mm ² ... 1.5 mm ²
Conductor cross section AWG	24 ... 16
Conductor cross section flexible, with ferrule without plastic sleeve	0.25 mm ² ... 1.5 mm ²
Conductor cross section, flexible, with ferrule, with plastic sleeve	0.14 mm ² ... 0.75 mm ²
Cylindrical gauge a x b / diameter	2.4 mm x 1.5 mm / -

Printed-circuit board connector - FMC 1,5/ 3-ST-3,5



1952270

<https://www.phoenixcontact.com/de/produkte/1952270>

Stripping length	10 mm
------------------	-------

Specifications for ferrules without insulating collar

recommended crimping tool	1212034 CRIMPFOX 6
ferrules without insulating collar, according to DIN 46228-1	Cross section: 0.25 mm ² ; Length: 7 mm
	Cross section: 0.34 mm ² ; Length: 7 mm
	Cross section: 0.5 mm ² ; Length: 8 mm ... 10 mm
	Cross section: 0.75 mm ² ; Length: 8 mm ... 10 mm
	Cross section: 1 mm ² ; Length: 8 mm ... 10 mm
	Cross section: 1.5 mm ² ; Length: 10 mm

Specifications for ferrules with insulating collar

recommended crimping tool	1212034 CRIMPFOX 6
ferrules with insulating collar, according to DIN 46228-4	Cross section: 0.14 mm ² ; Length: 8 mm
	Cross section: 0.25 mm ² ; Length: 8 mm ... 10 mm
	Cross section: 0.34 mm ² ; Length: 8 mm ... 10 mm
	Cross section: 0.5 mm ² ; Length: 8 mm ... 10 mm
	Cross section: 0.75 mm ² ; Length: 10 mm

Material specifications

Material data - contact

Note	WEEE/RoHS-compliant, free of whiskers according to IEC 60068-2-82/JEDEC JESD 201
Contact material	Cu alloy
Surface characteristics	hot-dip tin-plated
Metal surface terminal point (top layer)	Tin (4 - 8 µm Sn)
Metal surface contact area (top layer)	Tin (4 - 8 µm Sn)

Material data - housing

Housing color	green (6021)
Insulating material	PA
Insulating material group	I
CTI according to IEC 60112	600
Flammability rating according to UL 94	V0
Glow wire flammability index GWFI according to EN 60695-2-12	850
Glow wire ignition temperature GWIT according to EN 60695-2-13	775
Temperature for the ball pressure test according to EN 60695-10-2	125 °C

Material data – actuating element

Color of the actuating lever	orange (2003)
Insulating material	PBT
Insulating material group	I
CTI according to IEC 60112	600
Flammability rating according to UL 94	V0

Printed-circuit board connector - FMC 1,5/ 3-ST-3,5



1952270

<https://www.phoenixcontact.com/de/produkte/1952270>

Dimensions

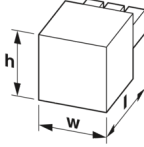
Dimensional drawing	
Pitch	3.5 mm
Width [w]	11.25 mm
Height [h]	7.75 mm
Length [l]	21.9 mm
Installed height	7.75 mm

Mechanical tests

Test for conductor damage and slackening

Specification	IEC 60999-1:1999-11
Result	Test passed

Repeated connection and disconnection

Specification	IEC 60999-1:1999-11
Result	Test passed

Pull-out test

Specification	IEC 60999-1:1999-11
Conductor cross section/conductor type/tractive force setpoint/actual value	0.2 mm ² / solid / > 10 N
	0.2 mm ² / flexible / > 10 N
	1.5 mm ² / solid / > 40 N
	1.5 mm ² / flexible / > 40 N

Insertion and withdrawal forces

Result	Test passed
No. of cycles	25
Insertion strength per pos. approx.	8 N
Withdraw strength per pos. approx.	6 N

Contact holder in insert

Specification	IEC 60512-15-1:2008-05
Contact holder in insert Requirements >20 N	Test passed

Resistance of inscriptions

Specification	IEC 60068-2-70:1995-12
Result	Test passed

Polarization and coding

Specification	IEC 60512-13-5:2006-02
---------------	------------------------

Printed-circuit board connector - FMC 1,5/ 3-ST-3,5



1952270

<https://www.phoenixcontact.com/de/produkte/1952270>

Result	Test passed
--------	-------------

Visual inspection

Specification	IEC 60512-1-1:2002-02
Result	Test passed

Dimension check

Specification	IEC 60512-1-2:2002-02
Result	Test passed

Environmental and real-life conditions

Vibration test

Specification	IEC 60068-2-6:2007-12
Frequency	10 - 150 - 10 Hz
Sweep speed	1 octave/min
Amplitude	0.35 mm (10 - 60.1 Hz)
Sweep speed	5g (60.1 - 150 Hz)
Test duration per axis	2.5 h

Durability test

Specification	IEC 60512-9-1:2010-03
Impulse withstand voltage at sea level	2.95 kV
Contact resistance R_1	1.5 m Ω
Contact resistance R_2	1.6 m Ω
Insertion/withdrawal cycles	25
Insulation resistance, neighboring positions	> 5 M Ω

Climatic test

Specification	ISO 6988:1985-02
Corrosive stress	0.2 dm ³ SO ₂ on 300 dm ³ /40 °C/1 cycle
Thermal stress	100 °C/168 h
Power-frequency withstand voltage	1.39 kV

Ambient conditions

Ambient temperature (operation)	-40 °C ... 100 °C (dependent on the derating curve)
Ambient temperature (storage/transport)	-40 °C ... 70 °C
Relative humidity (storage/transport)	30 % ... 70 %
Ambient temperature (assembly)	-5 °C ... 100 °C

Electrical tests

Thermal test | Test group C

Specification	IEC 60512-5-1:2002-02
Tested number of positions	20

Insulation resistance

Specification	IEC 60512-3-1:2002-02
---------------	-----------------------

Printed-circuit board connector - FMC 1,5/ 3-ST-3,5



1952270

<https://www.phoenixcontact.com/de/produkte/1952270>

Insulation resistance, neighboring positions	> 5 MΩ
--	--------

Air clearances and creepage distances |

Specification	IEC 60664-1:2007-04
Insulating material group	I
Comparative tracking index (IEC 60112)	CTI 600
Rated insulation voltage (III/3)	160 V
Rated surge voltage (III/3)	2.5 kV
minimum clearance value - non-homogenous field (III/3)	1.5 mm
minimum creepage distance (III/3)	2 mm
Rated insulation voltage (III/2)	160 V
Rated surge voltage (III/2)	2.5 kV
minimum clearance value - non-homogenous field (III/2)	1.5 mm
minimum creepage distance (III/2)	1.5 mm
Rated insulation voltage (II/2)	320 V
Rated surge voltage (II/2)	2.5 kV
minimum clearance value - non-homogenous field (II/2)	1.5 mm
minimum creepage distance (II/2)	1.6 mm

Packaging specifications

Type of packaging	packed in cardboard
-------------------	---------------------

Drawings

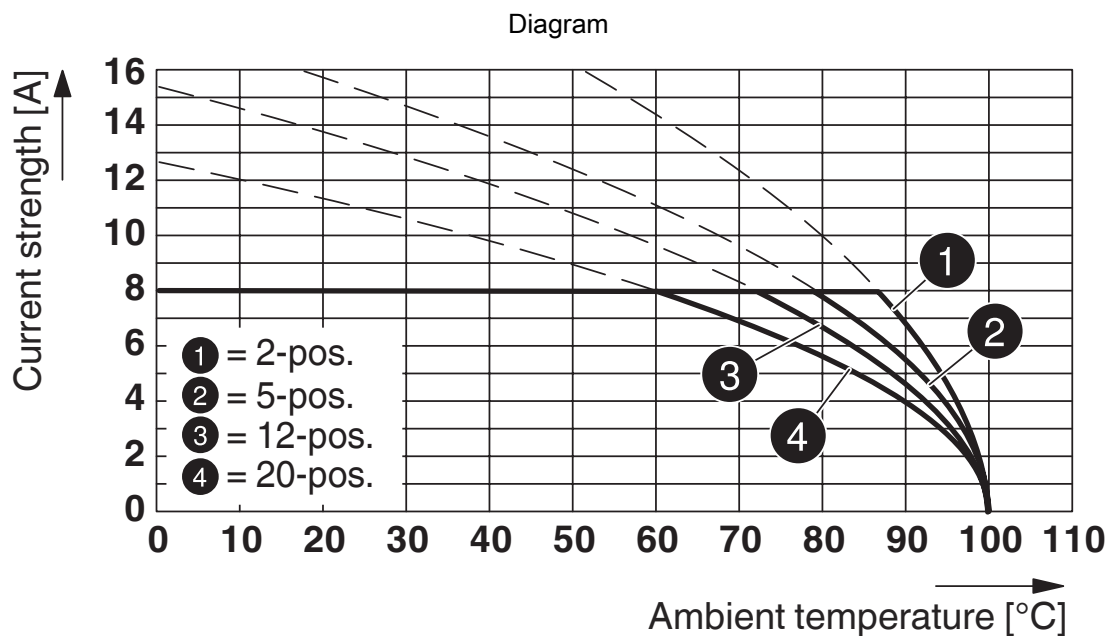

Type: FMC 1,5/...-ST-3,5 with MCV 1,5/...-G-3,5 P... THR

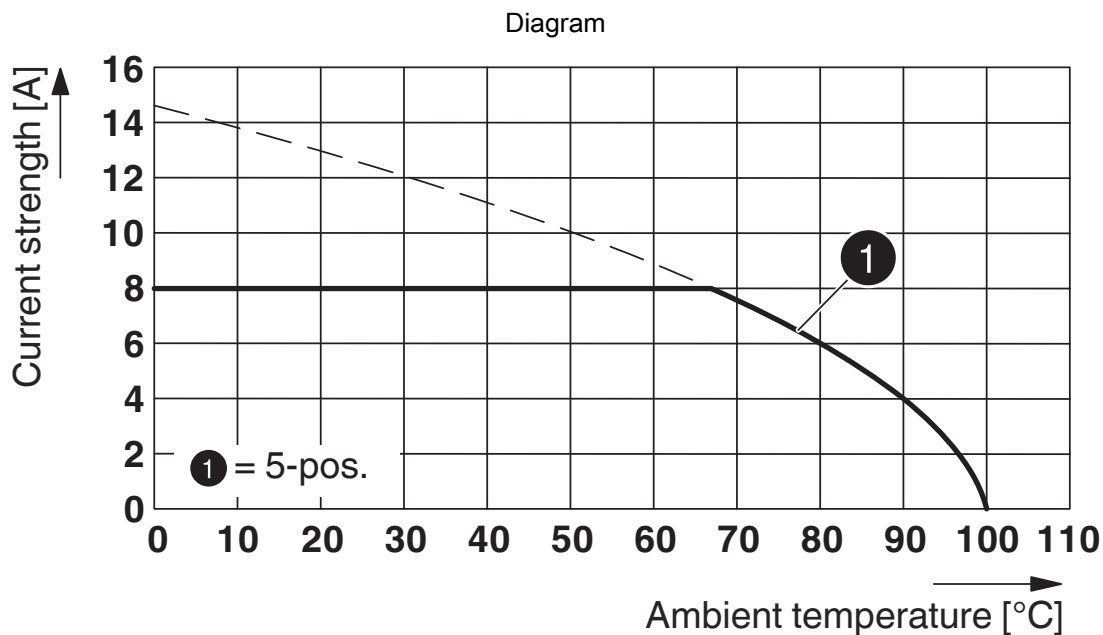

Type: FMC 1,5/...-ST-3,5 with MCD 1,5/...-G3-3,5 P26 THR MAG

1952270

<https://www.phoenixcontact.com/de/produkte/1952270>

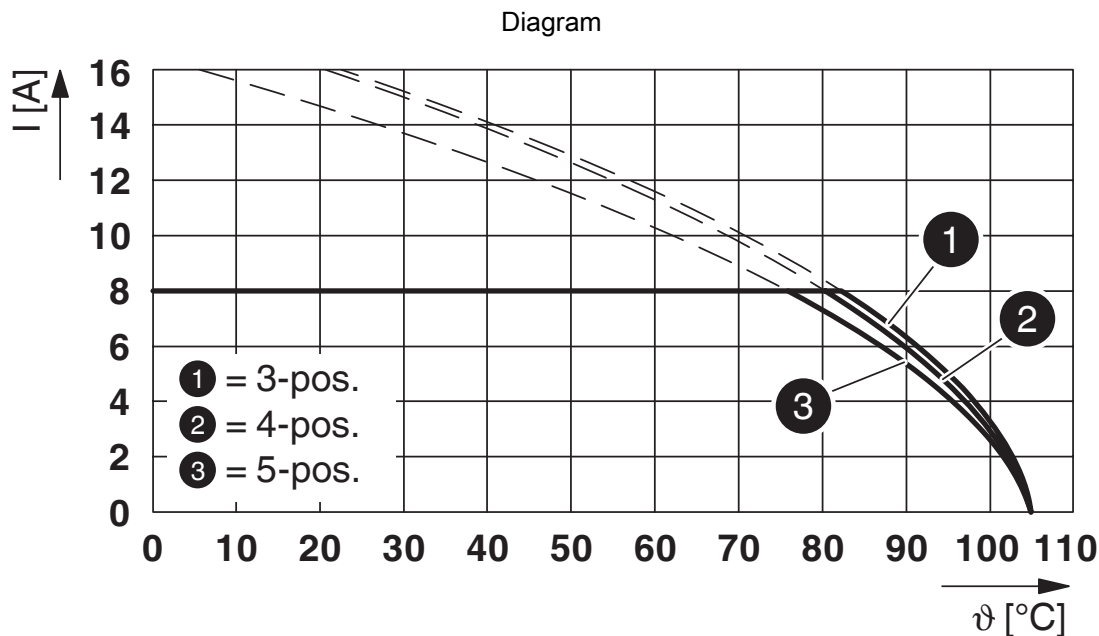

Type: FMC 1.5/...-ST-3.5 with MCO 1.5/...-G1L-3.5 KMGY

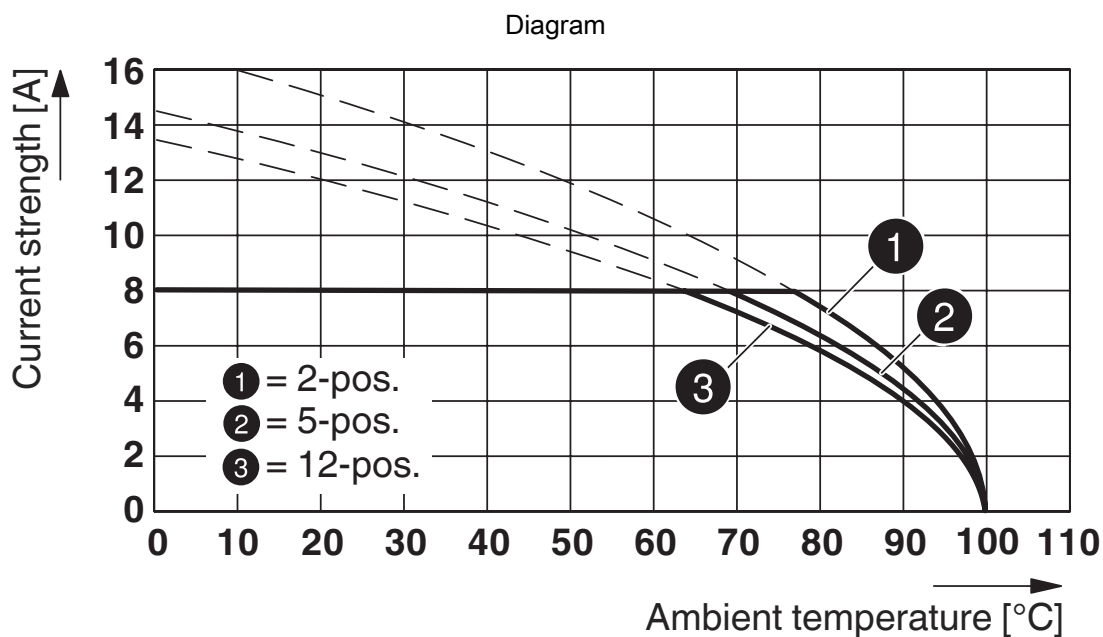

Type: FMC 1,5/...-ST-3,5 with IFMC 1,5/...-ST-3,5

1952270

<https://www.phoenixcontact.com/de/produkte/1952270>

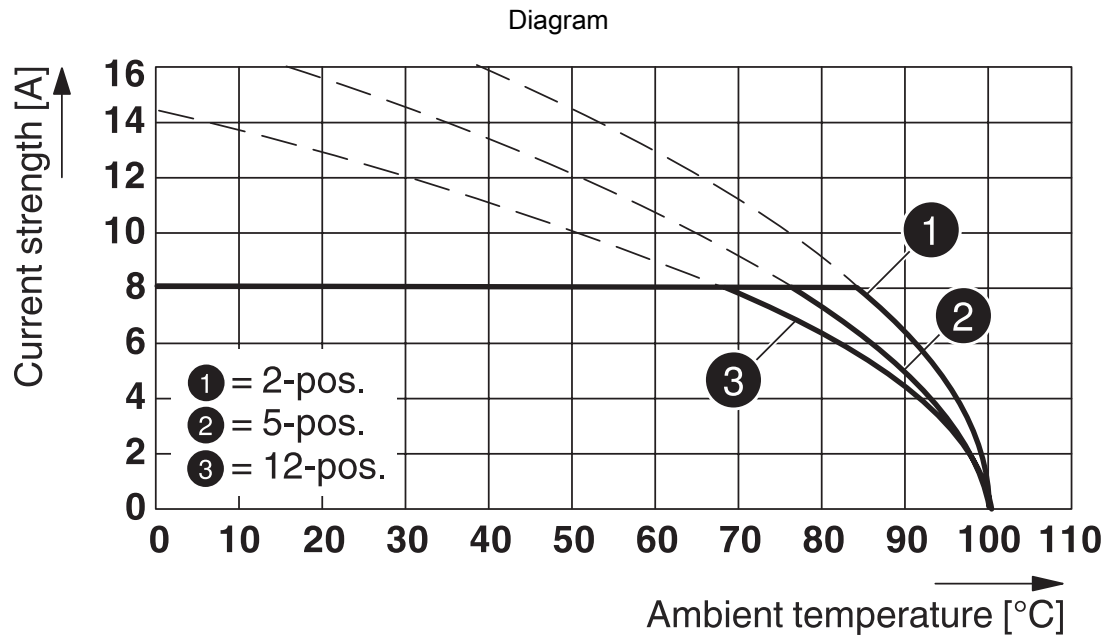

Type: FMC 1,5/...-ST-3,5 with MC 1,5/...-G-3,5 P... THR

Dimensional drawing

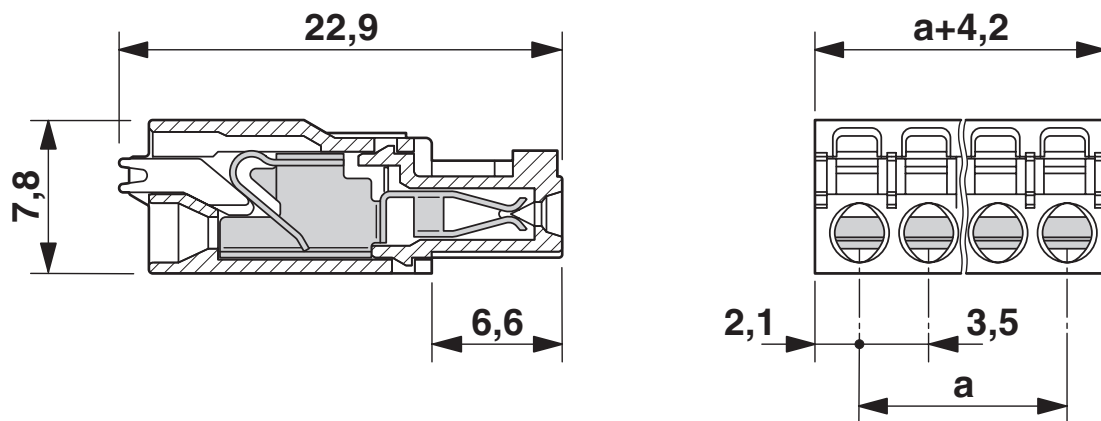

1952270

<https://www.phoenixcontact.com/de/produkte/1952270>

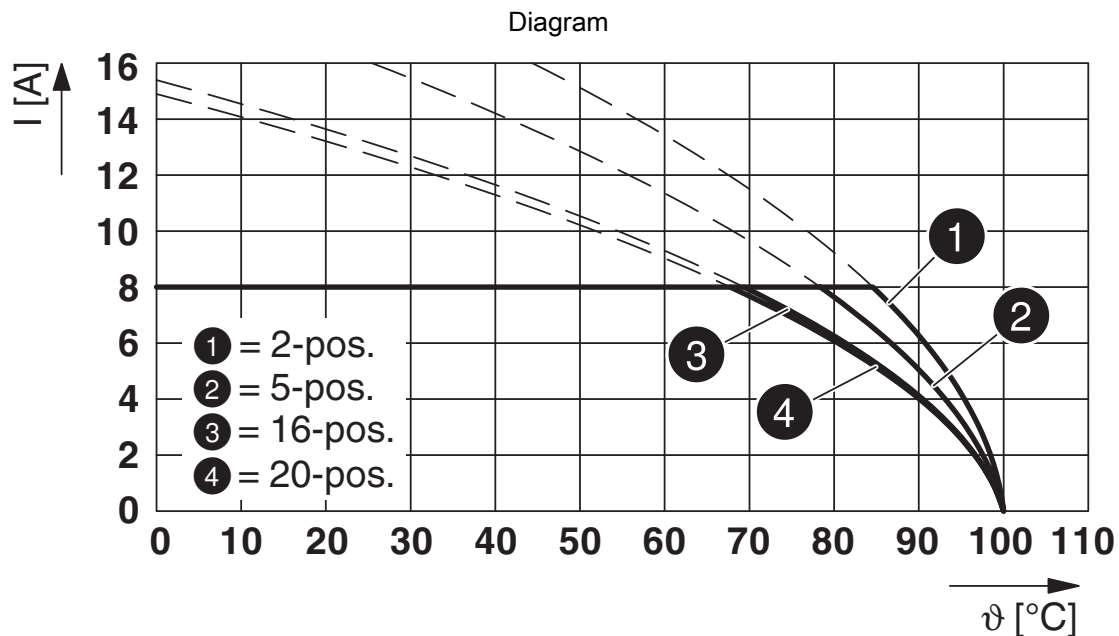

Type: FMC 1,5/...-ST-3,5 with MCV 1,5/...-G-3,5

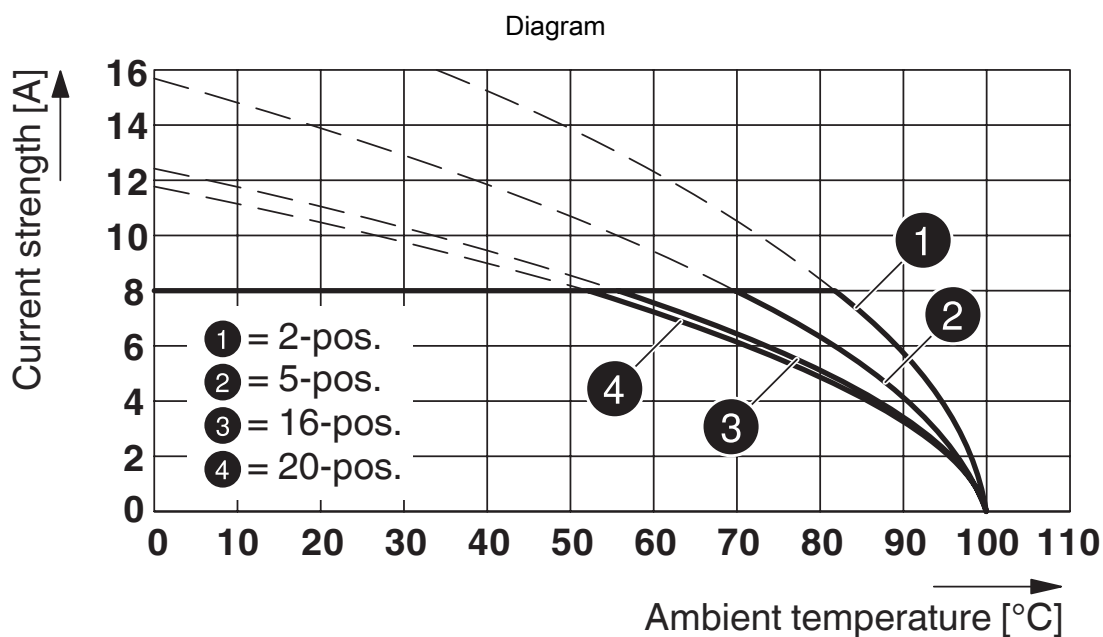

Type: FMC 1,5/...-ST-3,5 with MCDNV 1,5/...-G1-3,5 P...THR

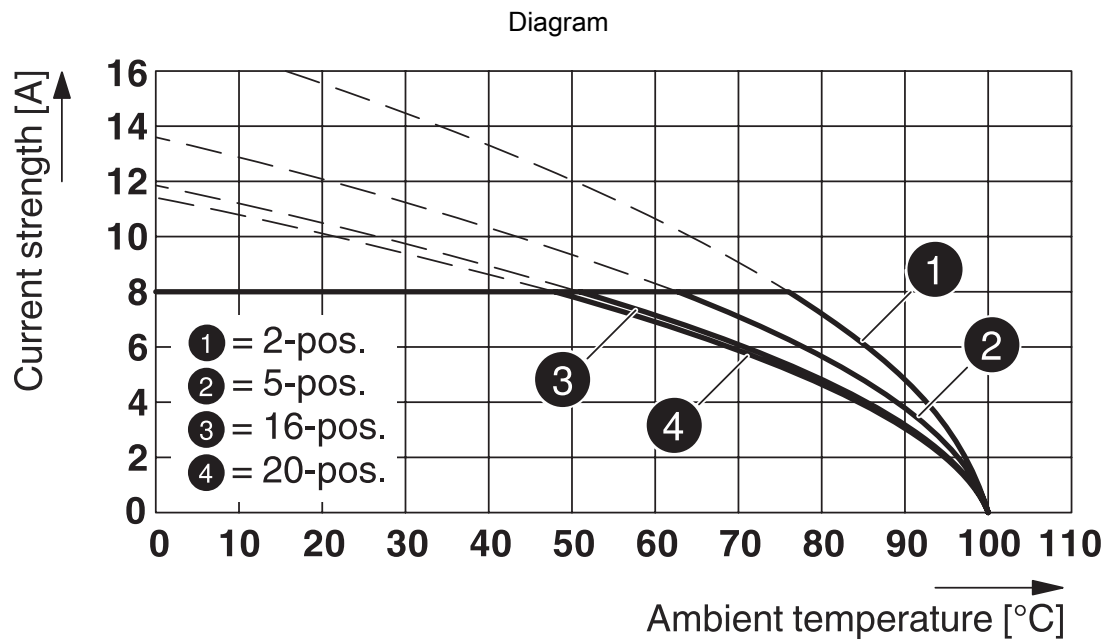

Type: FMC 1,5/...-ST-3,5 with MCDN 1,5/...-G1-3,5 P26THR

Printed-circuit board connector - FMC 1,5/ 3-ST-3,5





1952270

<https://www.phoenixcontact.com/de/produkte/1952270>

Approvals

 IECEE CB Scheme Approval ID: DE1-60987-B1B2				
	Nominal Voltage U_N	Nominal Current I_N	Cross Section AWG	Cross Section mm^2
	160 V	8 A	-	0.2 - 1.5

 EAC Approval ID: B.01687				
--	--	--	--	--

 cULus Recognized Approval ID: E60425-19920306				
	Nominal Voltage U_N	Nominal Current I_N	Cross Section AWG	Cross Section mm^2
Use group B				
Standard		8 A	24 - 16	-
Use group C				
Factory wiring	50 V	8 A	24 - 16	-

 VDE Gutachten mit Fertigungsüberwachung Approval ID: 40011723				
	Nominal Voltage U_N	Nominal Current I_N	Cross Section AWG	Cross Section mm^2
	160 V	8 A	-	0.2 - 1.5

Printed-circuit board connector - FMC 1,5/ 3-ST-3,5



1952270

<https://www.phoenixcontact.com/de/produkte/1952270>

Classifications

ECLASS

ECLASS-9.0	27440309
ECLASS-10.0.1	27440309
ECLASS-11.0	27460202

ETIM

ETIM 8.0	EC002638
----------	----------

UNSPSC

UNSPSC 21.0	39121400
-------------	----------

Printed-circuit board connector - FMC 1,5/ 3-ST-3,5



1952270

<https://www.phoenixcontact.com/de/produkte/1952270>

Environmental Product Compliance

China RoHS	Environmentally friendly use period: unlimited = EFUP-e
	No hazardous substances above threshold values

Printed-circuit board connector - FMC 1,5/ 3-ST-3,5

1952270

<https://www.phoenixcontact.com/de/produkte/1952270>

Accessories

Marker card

Marker card - SK 3,5/2,8:FORTL.ZAHLEN - 0804073

<https://www.phoenixcontact.com/de/produkte/0804073>

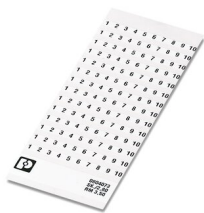

Marker card, white, labeled, horizontal: consecutive numbers 1 ... 10, 11 ... 20, etc. up to 91 ... 99, mounting type: adhesive, for terminal block width: 3.5 mm, lettering field size: 3.5 x 2.8 mm

Marker pen

Marker pen - B-STIFT - 1051993

<https://www.phoenixcontact.com/de/produkte/1051993>



Marker pen, for manual labeling of unprinted Zack strips, smear-proof and waterproof, line thickness 0.5 mm

Printed-circuit board connector - FMC 1,5/ 3-ST-3,5

1952270

<https://www.phoenixcontact.com/de/produkte/1952270>

Crimping pliers

Crimping pliers - CRIMPFOX 6 - 1212034

<https://www.phoenixcontact.com/de/produkte/1212034>



Crimping pliers, for ferrules without insulating collar according to DIN 46228 Part 1 and ferrules with insulating collar according to DIN 46228 Part 4, 0.25 mm² ... 6.0 mm², lateral entry, trapezoidal crimp

Screwdriver

Screwdriver - SZS 0,4X2,5 VDE - 1205037

<https://www.phoenixcontact.com/de/produkte/1205037>



Screwdriver, slot-headed, VDE insulated, size: 0.4 x 2.5 x 80 mm, 2-component grip, with non-slip grip

Printed-circuit board connector - FMC 1,5/ 3-ST-3,5



1952270

<https://www.phoenixcontact.com/de/produkte/1952270>

PCB header

PCB header - MCV 1,5/ 3-G-3,5 P20 THRR32 - 1780901

<https://www.phoenixcontact.com/de/produkte/1780901>

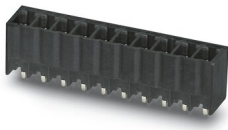

PCB headers, nominal cross section: 1.5 mm², color: black, nominal current: 8 A, rated voltage (III/2): 160 V, contact surface: Tin, type of contact: Male connector, number of potentials: 3, number of rows: 1, number of positions: 3, number of connections: 3, product range: MCV 1,5/...-G-THR, pitch: 3.5 mm, pin layout: Linear pinning, solder pin [P]: 2 mm, number of solder pins per potential: 1, plug-in system: COMBICON MC 1,5, Pin connector pattern alignment: Standard, locking: without, mounting: without, type of packaging: 32 mm wide tape, For user information and design recommendations for through-hole reflow technology, go to: Downloads

PCB header

PCB header - MCV 1,5/ 2-G-3,5 P20 THRR32 - 1780888

<https://www.phoenixcontact.com/de/produkte/1780888>

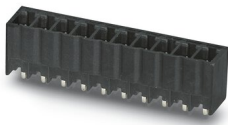

PCB headers, nominal cross section: 1.5 mm², color: black, nominal current: 8 A, rated voltage (III/2): 160 V, contact surface: Tin, type of contact: Male connector, number of potentials: 2, number of rows: 1, number of positions: 2, number of connections: 2, product range: MCV 1,5/...-G-THR, pitch: 3.5 mm, pin layout: Linear pinning, solder pin [P]: 2 mm, number of solder pins per potential: 1, plug-in system: COMBICON MC 1,5, Pin connector pattern alignment: Standard, locking: without, mounting: without, type of packaging: 32 mm wide tape, For user information and design recommendations for through-hole reflow technology, go to: Downloads

Printed-circuit board connector - FMC 1,5/ 3-ST-3,5



1952270

<https://www.phoenixcontact.com/de/produkte/1952270>

PCB header

PCB header - MC 1,5/ 3-G-3,5 P26 THR - 1788521

<https://www.phoenixcontact.com/de/produkte/1788521>

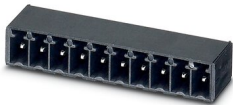

PCB headers, nominal cross section: 1.5 mm², color: black, nominal current: 8 A, rated voltage (III/2): 160 V, contact surface: Tin, type of contact: Male connector, number of potentials: 3, number of rows: 1, number of positions: 3, number of connections: 3, product range: MC 1,5/...-G-THR, pitch: 3.5 mm, pin layout: Linear pinning, solder pin [P]: 2.6 mm, number of solder pins per potential: 1, plug-in system: COMBICON MC 1,5, Pin connector pattern alignment: Standard, locking: without, mounting: without, type of packaging: packed in cardboard

PCB header

PCB header - MC 1,5/ 2-G-3,5 P26 THR - 1788505

<https://www.phoenixcontact.com/de/produkte/1788505>

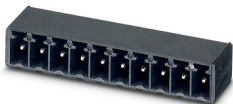

PCB headers, nominal cross section: 1.5 mm², color: black, nominal current: 8 A, rated voltage (III/2): 160 V, contact surface: Tin, type of contact: Male connector, number of potentials: 2, number of rows: 1, number of positions: 2, number of connections: 2, product range: MC 1,5/...-G-THR, pitch: 3.5 mm, pin layout: Linear pinning, solder pin [P]: 2.6 mm, number of solder pins per potential: 1, plug-in system: COMBICON MC 1,5, Pin connector pattern alignment: Standard, locking: without, mounting: without, type of packaging: packed in cardboard

Printed-circuit board connector - FMC 1,5/ 3-ST-3,5



1952270

<https://www.phoenixcontact.com/de/produkte/1952270>

PCB header

PCB header - MC 1,5/ 3-G-3,5 P26 THRR32 - 1788534

<https://www.phoenixcontact.com/de/produkte/1788534>

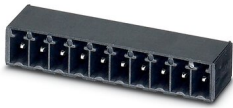

PCB headers, nominal cross section: 1.5 mm², color: black, nominal current: 8 A, rated voltage (III/2): 160 V, contact surface: Tin, type of contact: Male connector, number of potentials: 3, number of rows: 1, number of positions: 3, number of connections: 3, product range: MC 1,5/...-G-THR, pitch: 3.5 mm, pin layout: Linear pinning, solder pin [P]: 2.6 mm, number of solder pins per potential: 1, plug-in system: COMBICON MC 1,5, Pin connector pattern alignment: Standard, locking: without, mounting: without, type of packaging: 32 mm wide tape

PCB header

PCB header - MC 1,5/ 2-G-3,5 P26 THRR32 - 1788518

<https://www.phoenixcontact.com/de/produkte/1788518>

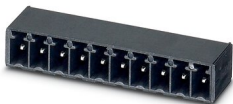

PCB headers, nominal cross section: 1.5 mm², color: black, nominal current: 8 A, rated voltage (III/2): 160 V, contact surface: Tin, type of contact: Male connector, number of potentials: 2, number of rows: 1, number of positions: 2, number of connections: 2, product range: MC 1,5/...-G-THR, pitch: 3.5 mm, pin layout: Linear pinning, solder pin [P]: 2.6 mm, number of solder pins per potential: 1, plug-in system: COMBICON MC 1,5, Pin connector pattern alignment: Standard, locking: without, mounting: without, type of packaging: 32 mm wide tape

Printed-circuit board connector - FMC 1,5/ 3-ST-3,5

1952270

<https://www.phoenixcontact.com/de/produkte/1952270>

PCB header

PCB header - MC 1,5/ 3-G-3,5 P20 THRR32 - 1788754

<https://www.phoenixcontact.com/de/produkte/1788754>

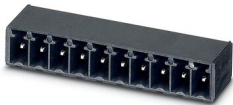

PCB headers, nominal cross section: 1.5 mm², color: black, nominal current: 8 A, rated voltage (III/2): 160 V, contact surface: Tin, type of contact: Male connector, number of potentials: 3, number of rows: 1, number of positions: 3, number of connections: 3, product range: MC 1,5/...-G-THR, pitch: 3.5 mm, pin layout: Linear pinning, solder pin [P]: 2 mm, number of solder pins per potential: 1, plug-in system: COMBICON MC 1,5, Pin connector pattern alignment: Standard, locking: without, mounting: without, type of packaging: 32 mm wide tape

PCB header

PCB header - MC 1,5/ 2-G-3,5 P20 THRR32 - 1788738

<https://www.phoenixcontact.com/de/produkte/1788738>

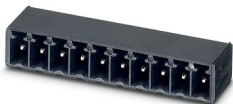

PCB headers, nominal cross section: 1.5 mm², color: black, nominal current: 8 A, rated voltage (III/2): 160 V, contact surface: Tin, type of contact: Male connector, number of potentials: 2, number of rows: 1, number of positions: 2, number of connections: 2, product range: MC 1,5/...-G-THR, pitch: 3.5 mm, pin layout: Linear pinning, solder pin [P]: 2 mm, number of solder pins per potential: 1, plug-in system: COMBICON MC 1,5, Pin connector pattern alignment: Standard, locking: without, mounting: without, type of packaging: 32 mm wide tape

Printed-circuit board connector - FMC 1,5/ 3-ST-3,5



1952270

<https://www.phoenixcontact.com/de/produkte/1952270>

PCB header

PCB header - MC 1,5/ 3-G-3,5 P14 THR - 1788961

<https://www.phoenixcontact.com/de/produkte/1788961>

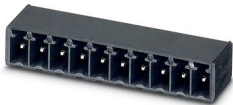

PCB headers, nominal cross section: 1.5 mm², color: black, nominal current: 8 A, rated voltage (III/2): 160 V, contact surface: Tin, type of contact: Male connector, number of potentials: 3, number of rows: 1, number of positions: 3, number of connections: 3, product range: MC 1,5/...-G-THR, pitch: 3.5 mm, pin layout: Linear pinning, solder pin [P]: 1.4 mm, number of solder pins per potential: 1, plug-in system: COMBICON MC 1,5, Pin connector pattern alignment: Standard, locking: without, mounting: without, type of packaging: packed in cardboard

PCB header

PCB header - MC 1,5/ 2-G-3,5 P14 THR - 1788945

<https://www.phoenixcontact.com/de/produkte/1788945>

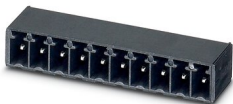

PCB headers, nominal cross section: 1.5 mm², color: black, nominal current: 8 A, rated voltage (III/2): 160 V, contact surface: Tin, type of contact: Male connector, number of potentials: 2, number of rows: 1, number of positions: 2, number of connections: 2, product range: MC 1,5/...-G-THR, pitch: 3.5 mm, pin layout: Linear pinning, solder pin [P]: 1.4 mm, number of solder pins per potential: 1, plug-in system: COMBICON MC 1,5, Pin connector pattern alignment: Standard, locking: without, mounting: without, type of packaging: packed in cardboard

Printed-circuit board connector - FMC 1,5/ 3-ST-3,5

1952270

<https://www.phoenixcontact.com/de/produkte/1952270>

PCB header

PCB header - MC 1,5/ 3-G-3,5 P14 THRR32 - 1788974

<https://www.phoenixcontact.com/de/produkte/1788974>

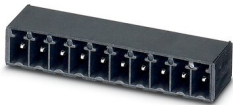

PCB headers, nominal cross section: 1.5 mm², color: black, nominal current: 8 A, rated voltage (III/2): 160 V, contact surface: Tin, type of contact: Male connector, number of potentials: 3, number of rows: 1, number of positions: 3, number of connections: 3, product range: MC 1,5/...-G-THR, pitch: 3.5 mm, pin layout: Linear pinning, solder pin [P]: 1.4 mm, number of solder pins per potential: 1, plug-in system: COMBICON MC 1,5, Pin connector pattern alignment: Standard, locking: without, mounting: without, type of packaging: 32 mm wide tape

PCB header

PCB header - MC 1,5/ 2-G-3,5 P14 THRR32 - 1788958

<https://www.phoenixcontact.com/de/produkte/1788958>

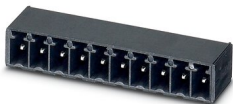

PCB headers, nominal cross section: 1.5 mm², color: black, nominal current: 8 A, rated voltage (III/2): 160 V, contact surface: Tin, type of contact: Male connector, number of potentials: 2, number of rows: 1, number of positions: 2, number of connections: 2, product range: MC 1,5/...-G-THR, pitch: 3.5 mm, pin layout: Linear pinning, solder pin [P]: 1.4 mm, number of solder pins per potential: 1, plug-in system: COMBICON MC 1,5, Pin connector pattern alignment: Standard, locking: without, mounting: without, type of packaging: 32 mm wide tape

Printed-circuit board connector - FMC 1,5/ 3-ST-3,5



1952270

<https://www.phoenixcontact.com/de/produkte/1952270>

PCB header

PCB header - MCV 1,5/ 3-G-3,5 - 1843619

<https://www.phoenixcontact.com/de/produkte/1843619>



PCB headers, nominal cross section: 1.5 mm², color: green, nominal current: 8 A, rated voltage (III/2): 160 V, contact surface: Tin, type of contact: Male connector, number of potentials: 3, number of rows: 1, number of positions: 3, number of connections: 3, product range: MCV 1,5/...-G, pitch: 3.5 mm, pin layout: Linear pinning, solder pin [P]: 3.4 mm, number of solder pins per potential: 1, plug-in system: COMBICON MC 1,5, Pin connector pattern alignment: Standard, locking: without, mounting: without, type of packaging: packed in cardboard

PCB header

PCB header - MCV 1,5/ 2-G-3,5 - 1843606

<https://www.phoenixcontact.com/de/produkte/1843606>

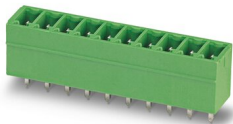

PCB headers, nominal cross section: 1.5 mm², color: green, nominal current: 8 A, rated voltage (III/2): 160 V, contact surface: Tin, type of contact: Male connector, number of potentials: 2, number of rows: 1, number of positions: 2, number of connections: 2, product range: MCV 1,5/...-G, pitch: 3.5 mm, pin layout: Linear pinning, solder pin [P]: 3.4 mm, number of solder pins per potential: 1, plug-in system: COMBICON MC 1,5, Pin connector pattern alignment: Standard, locking: without, mounting: without, type of packaging: packed in cardboard

Printed-circuit board connector - FMC 1,5/ 3-ST-3,5

1952270

<https://www.phoenixcontact.com/de/produkte/1952270>

PCB header

PCB header - MC 1,5/ 3-G-3,5 - 1844223

<https://www.phoenixcontact.com/de/produkte/1844223>

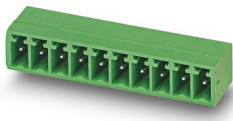

PCB headers, nominal cross section: 1.5 mm², color: green, nominal current: 8 A, rated voltage (III/2): 160 V, contact surface: Tin, type of contact: Male connector, number of potentials: 3, number of rows: 1, number of positions: 3, number of connections: 3, product range: MC 1,5/..-G, pitch: 3.5 mm, screw head form: L Slotted, pin layout: Linear pinning, solder pin [P]: 3.4 mm, number of solder pins per potential: 1, plug-in system: COMBICON MC 1,5, Pin connector pattern alignment: Standard, locking: without, mounting: without, type of packaging: packed in cardboard

PCB header

PCB header - MC 1,5/ 2-G-3,5 - 1844210

<https://www.phoenixcontact.com/de/produkte/1844210>

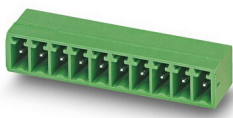

PCB headers, nominal cross section: 1.5 mm², color: green, nominal current: 8 A, rated voltage (III/2): 160 V, contact surface: Tin, type of contact: Male connector, number of potentials: 2, number of rows: 1, number of positions: 2, number of connections: 2, product range: MC 1,5/..-G, pitch: 3.5 mm, pin layout: Linear pinning, solder pin [P]: 3.4 mm, number of solder pins per potential: 1, plug-in system: COMBICON MC 1,5, Pin connector pattern alignment: Standard, locking: without, mounting: without, type of packaging: packed in cardboard

Printed-circuit board connector - FMC 1,5/ 3-ST-3,5

1952270

<https://www.phoenixcontact.com/de/produkte/1952270>

PCB header

PCB header - MCO 1,5/ 3-G1R-3,5 KMGY - 2278322

<https://www.phoenixcontact.com/de/produkte/2278322>



PCB headers, nominal cross section: 1.5 mm², color: light grey, nominal current: 8 A, rated voltage (III/2): 160 V, contact surface: Tin, type of contact: Male connector, number of potentials: 3, number of rows: 1, number of positions: 3, number of connections: 3, product range: MCO 1,5/...-G1R, pitch: 3.5 mm, pin layout: Linear pinning, solder pin [P]: 3.5 mm, locking: without, type of packaging: packed in cardboard, Product with pin output on right side

PCB header

PCB header - MCDNV 1,5/ 2-G1-3,5 P26THR - 1952788

<https://www.phoenixcontact.com/de/produkte/1952788>

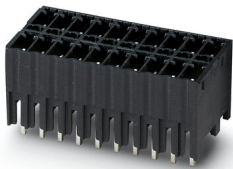

PCB headers, nominal cross section: 1.5 mm², color: black, nominal current: 8 A, rated voltage (III/2): 160 V, contact surface: Tin, type of contact: Male connector, number of potentials: 4, number of rows: 2, number of positions: 2, number of connections: 4, product range: MCDNV 1,5/...-G1-THR, pitch: 3.5 mm, pin layout: Linear pinning, solder pin [P]: 2.6 mm, number of solder pins per potential: 1, plug-in system: COMBICON MC 1,5, Pin connector pattern alignment: Standard, locking: without, mounting: without, type of packaging: packed in cardboard, The pin length is 26 mm. User information and design recommendations on Through Hole Reflow Technology can be found at: [http: "Downloads"](http://www.phoenixcontact.com/Downloads).

Printed-circuit board connector - FMC 1,5/ 3-ST-3,5



1952270

<https://www.phoenixcontact.com/de/produkte/1952270>

PCB header

PCB header - MCDN 1,5/ 2-G1-3,5 P26THR - 1953716

<https://www.phoenixcontact.com/de/produkte/1953716>

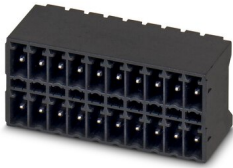

PCB headers, nominal cross section: 1.5 mm², color: black, nominal current: 8 A, rated voltage (III/2): 160 V, contact surface: Tin, type of contact: Male connector, number of potentials: 4, number of rows: 2, number of positions: 2, number of connections: 4, product range: MCDN 1,5/..-G1-THR, pitch: 3.5 mm, pin layout: Linear pinning, solder pin [P]: 2.6 mm, number of solder pins per potential: 1, plug-in system: COMBICON MC 1,5, Pin connector pattern alignment: Standard, locking: without, mounting: without, type of packaging: packed in cardboard, The pin length is 2.6 mm. User information and design recommendations on Through Hole Reflow Technology can be found at: "Downloads"

Phoenix Contact 2022 © - all rights reserved

<https://www.phoenixcontact.com>

PHOENIX CONTACT Deutschland GmbH

Flachsmarktstraße 8

D-32825 Blomberg

+49 52 35/3-1 20 00

info@phoenixcontact.de