

Sensor/actuator cable - SAC-3P- 3,0-PUR/M12FR



1694512

<https://www.phoenixcontact.com/de/produkte/1694512>

Please be informed that the data shown in this PDF document is generated from our Online Catalog. Please find the complete data in the user documentation. Our General Terms of Use for Downloads are valid.



Sensor/actuator cable, 3-position, PUR halogen-free, black-gray RAL 7021, free cable end, on Socket angled M12, coding: A, cable length: 3 m

Your advantages

- Easy and safe: 100% electrically tested plug-in components

Sensor/actuator cable - SAC-3P- 3,0-PUR/M12FR



1694512

<https://www.phoenixcontact.com/de/produkte/1694512>

Commercial Data

Item number	1694512
Packing unit	1 pc
Minimum order quantity	1 pc
Sales Key	C1 - Sensor-Aktor-Kabel
Product Key	BF1CBA
Catalog Page	Page 188 (C-2-2019)
GTIN	4017918178383
Weight per Piece (including packing)	73,3 g
Weight per Piece (excluding packing)	68,5 g
Customs tariff number	85444290
Country of origin	DE

Technical Data

Product properties

Product type	Sensor/actuator cable
Number of positions	3
Application	Standard
No. of cable outlets	1
Shielded	no
Coding	A - standard

Insulation characteristics

Overvoltage category	II
Degree of pollution	3

Material specifications

Flammability rating according to UL 94	HB
Sealing material	NBR
Material of grip body	TPU, hardly inflammable, self-extinguishing
Contact material	CuSn
Contact surface material	Ni/Au
Contact carrier material	TPU GF
Cable gland material	Zinc die-cast, nickel-plated

Electrical properties

Contact resistance	≤ 5 mΩ
Insulation resistance	≥ 100 MΩ
Nominal voltage U _N	250 V AC
	250 V DC
Nominal current I _N	4 A
Protective circuit	unwired

Connection data

Conductor connection

Tightening torque	0.4 NmM12 connector
-------------------	---------------------

Connector

Insertion/withdrawal cycles	≥ 100
-----------------------------	-------

Header 1

Head design	free cable end
-------------	----------------

Header 2

Head design	Socket
Head cable outlet	angled
Head thread type	M12

Sensor/actuator cable - SAC-3P- 3,0-PUR/M12FR



1694512

<https://www.phoenixcontact.com/de/produkte/1694512>

Coding	A
--------	---

LED signaling

Status display	No
Status display present	No

Cable / line

Cable length	3 m
Cable weight	23 kg/km
UL AWM Style	20549
Number of positions	3
Shielded	no
Cable type	PUR halogen-free black [PUR]
Conductor structure signal line	42x 0.10 mm
AWG signal line	22
Conductor cross section	3x 0.34 mm ² (Signal line)
Wire diameter incl. insulation	1.27 mm ±0.02 mm (Signal line)
External cable diameter	3.85 mm ±0.15 mm
Outer sheath, material	PUR
External sheath, color	black-gray RAL 7021
Conductor material	Bare Cu litz wires
Material wire insulation	PP
Single wire, color	brown, blue, black
Thickness, insulation	≥ 0.21 mm (Core insulation) approx. 0.5 mm (Outer cable sheath)
Overall twist	3 wires, twisted
Max. conductor resistance	max. 58 Ω/km (at 20 °C)
Insulation resistance	≥ 100 GΩ*km (at 20 °C)
Nominal voltage, cable	≤ 300 V
Test voltage	≥ 3000 V
Smallest bending radius, fixed installation	19 mm
Smallest bending radius, movable installation	38 mm
Max. bending cycles	10000000
Halogen-free	in accordance with DIN VDE 0472 part 815
Flame resistance	in accordance with UL 758/1581 FT2 DIN EN 60332-2-2 (20 s)
Resistance to oil	in accordance with DIN EN 60811-2-1
Other resistance	Highly resistant to acids, alkaline solutions and solvents hydrolysis and microbe resistant partly UV-resistant in accordance with DIN EN ISO 4892-2-A
Special properties	Flexible cable conduit capable Silicone-free Free of substances which would hinder coating with paint or varnish

Sensor/actuator cable - SAC-3P- 3,0-PUR/M12FR



1694512

<https://www.phoenixcontact.com/de/produkte/1694512>

Ambient temperature (operation)	-40 °C ... 80 °C (cable, fixed installation)
	-25 °C ... 80 °C (Cable, flexible installation)
Cable weight	26 kg/km

Cable structure

Cable abbreviation	Li9Y11Y
Cable type	PUR halogen-free black
External cable diameter	4.40 mm
Outer sheath, material	PUR
External sheath, color	black-gray RAL 7021
Conductor material	Bare Cu litz wires
Conductor structure signal line	42x 0.10 mm
AWG signal line	22
Material wire insulation	PP
Thickness, insulation	≥ 0.21 mm (Core insulation)
Wire diameter incl. insulation	1.27 mm ±0.02 mm
Single wire, color	brown, blue, black
Overall twist	3 wires, twisted

Electrical properties

Nominal voltage, cable	300 V
Test voltage, cable	3000 V
Conductor resistance	≤ 58 Ω/m
Cable insulation resistance	≥ 100 GΩ*km

Mechanical properties

Smallest bending radius, movable installation	44 mm
Number of bending cycles	4000000
Bending radius	44 mm
Traversing path	10 m
Traversing rate	3 m/s

Bending cycles

Smallest bending radius, movable installation	44 mm
Number of bending cycles	4000000
Bending radius	44 mm
Traversing path	10 m
Traversing rate	3 m/s

Ambient conditions

Degree of protection	IP65
	IP67
	IP68
Ambient temperature (operation)	-25 °C ... 90 °C (Plug / socket)

Standards and regulations

Sensor/actuator cable - SAC-3P- 3,0-PUR/M12FR



1694512

<https://www.phoenixcontact.com/de/produkte/1694512>

Standards/specifications

IEC 61076-2-101

1694512

<https://www.phoenixcontact.com/de/produkte/1694512>

Drawings

Schematic diagram

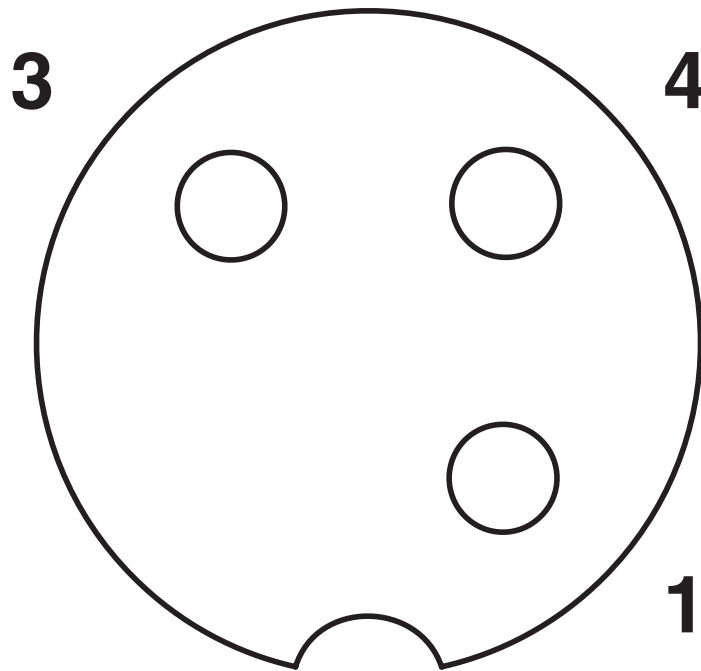

Pin assignment M12 socket, 3-pos., A-coded, view female side

Circuit diagram

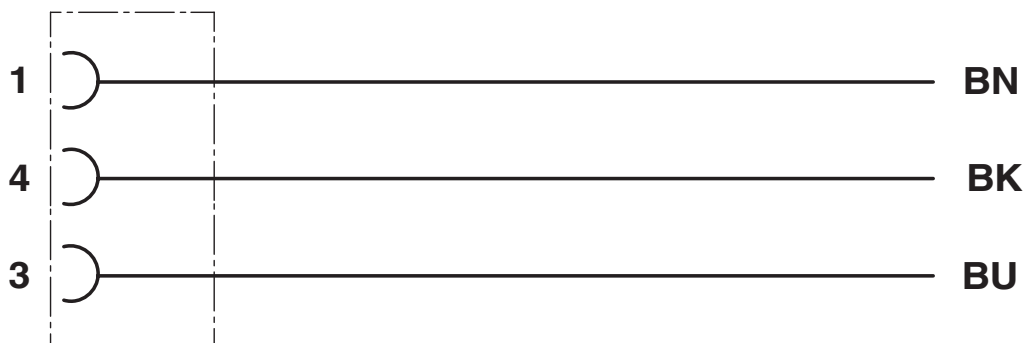

Contact assignment of the M12 socket

Sensor/actuator cable - SAC-3P- 3,0-PUR/M12FR

1694512

<https://www.phoenixcontact.com/de/produkte/1694512>



Dimensional drawing

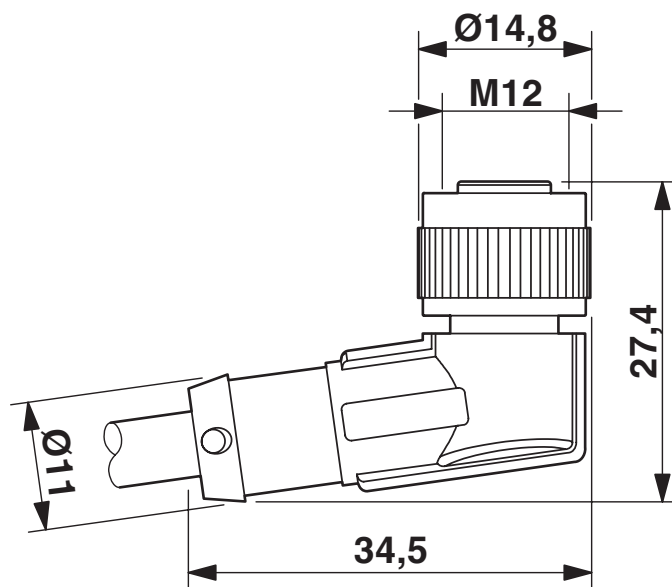

M12 x 1 socket, angled

Sensor/actuator cable - SAC-3P- 3,0-PUR/M12FR



1694512

<https://www.phoenixcontact.com/de/produkte/1694512>

Approvals



EAC

Approval ID: RU C-DE.BL08.B.00286



UL Listed

Approval ID: FILE E 221474

	Nominal Voltage U_N	Nominal Current I_N	Cross Section AWG	Cross Section mm^2
	300 V	4 A	-	-



cUL Listed

Approval ID: FILE E 221474

	Nominal Voltage U_N	Nominal Current I_N	Cross Section AWG	Cross Section mm^2
	300 V	4 A	-	-



EAC

Approval ID: RU D-DE.HB35.B.00387

cULus Listed

Sensor/actuator cable - SAC-3P- 3,0-PUR/M12FR



1694512

<https://www.phoenixcontact.com/de/produkte/1694512>

Classifications

ECLASS

ECLASS-9.0	27060311
ECLASS-10.0.1	27060311
ECLASS-11.0	27060311

ETIM

ETIM 8.0	EC001855
----------	----------

UNSPSC

UNSPSC 21.0	26121600
-------------	----------

Sensor/actuator cable - SAC-3P- 3,0-PUR/M12FR



1694512

<https://www.phoenixcontact.com/de/produkte/1694512>

Environmental Product Compliance

China RoHS	Environmentally friendly use period: unlimited = EFUP-e
	No hazardous substances above threshold values

1694512

<https://www.phoenixcontact.com/de/produkte/1694512>

Accessories

Insert label

Insert label - PABA WH/23 - 1013779

<https://www.phoenixcontact.com/de/produkte/1013779>



Insert label, Strip, white, unlabeled, can be labeled with: CMS-P1-PLOTTER, mounting type: slide-on, cable diameter range: 1.5 ... 35 mm, lettering field size: 23 x 4 mm, Number of individual labels: 20

Insert label

Insert label - PABA YE/23 - 1013782

<https://www.phoenixcontact.com/de/produkte/1013782>



Insert label, Strip, yellow, unlabeled, can be labeled with: CMS-P1-PLOTTER, mounting type: slide-on, cable diameter range: 1.5 ... 35 mm, lettering field size: 23 x 4 mm, Number of individual labels: 20

Sensor/actuator cable - SAC-3P- 3,0-PUR/M12FR

1694512

<https://www.phoenixcontact.com/de/produkte/1694512>

Marker pen

Marker pen - B-STIFT - 1051993

<https://www.phoenixcontact.com/de/produkte/1051993>



Marker pen, for manual labeling of unprinted Zack strips, smear-proof and waterproof, line thickness 0.5 mm

Diagonal cutter

Diagonal cutter - CUTFOX-S VDE - 1212207

<https://www.phoenixcontact.com/de/produkte/1212207>



Diagonal cutter for hard (piano wire) and soft wires, VDE 1000 V AC/1500 V DC tested

Sensor/actuator cable - SAC-3P- 3,0-PUR/M12FR

1694512

<https://www.phoenixcontact.com/de/produkte/1694512>

Stripping tool

Stripping tool - WIREFOX SAC-1 - 1212757

<https://www.phoenixcontact.com/de/produkte/1212757>



Stripping pliers, for halogen-free sensor/actuator cables (SAC cables), with PUR and PVC insulation, from Ø of 3.2 to 4.4 mm, any stripping length

Stripping tool

Stripping tool - WIREFOX SAC - 1212623

<https://www.phoenixcontact.com/de/produkte/1212623>



Stripping pliers, for halogen-free sensor/actuator cables (SAC cables), with PUR and PVC insulation, from Ø of 4.4 to 7 mm, any stripping length

Sensor/actuator cable - SAC-3P- 3,0-PUR/M12FR

1694512

<https://www.phoenixcontact.com/de/produkte/1694512>

Stripping tool

Stripping tool - WIREFOX 10 - 1212150

<https://www.phoenixcontact.com/de/produkte/1212150>



Stripping tool, for cables and conductors from 0.02 - 10 mm², self-adjusting, stripping length of up to 18 mm, cutting capacity of up to 10 mm² stranded/1.5 mm² solid, replaceable stripping blade

Protective hose adapter

Protective hose adapter - WP-CTA POM 13,0 BK - 1422884

<https://www.phoenixcontact.com/de/produkte/1422884>



Protective hose adapter, for corrugated hoses with a nominal size of 13 (10 x 13), corrugated in parallel

Sensor/actuator cable - SAC-3P- 3,0-PUR/M12FR

1694512

<https://www.phoenixcontact.com/de/produkte/1694512>

Protective hose

Protective hose - WP-PA HF 13,0 BK - 3240681

<https://www.phoenixcontact.com/de/produkte/3240681>



Protective hose, material: PA 6, filament: without, UV-resistant: yes, flexible, degree of protection: IP68, color: black, inflammability class in acc. with UL 94: V0, inner diameter: 10 mm, Total length: 50 m

Protective hose

Protective hose - WP-PA HF-HB 13,0 BK - 3240839

<https://www.phoenixcontact.com/de/produkte/3240839>



Protective hose, material: PA 6, filament: without, UV-resistant: yes, flexible, degree of protection: IP68, color: black, inflammability class in acc. with UL 94: HB, inner diameter: 10 mm, Total length: 50 m

Sensor/actuator cable - SAC-3P- 3,0-PUR/M12FR



1694512

<https://www.phoenixcontact.com/de/produkte/1694512>

Screw plug

Screw plug - PROT-M12 MS-PA-CHAIN - 1430899

<https://www.phoenixcontact.com/de/produkte/1430899>

M12 sealing cap with fixing band, for sensor cables, for free M12 sockets



Locking clip

Locking clip - SAC-M12-EXCLIP-F - 1558991

<https://www.phoenixcontact.com/de/produkte/1558991>

Locking clip for the socket side of sensor/actuator cables with M12 connector and M12 connectors for assembly, for knurl diameter: 15 mm or for Allen key with a wrench size of 14 mm, prevents the disconnection of plug-in connections without tools



Sensor/actuator cable - SAC-3P- 3,0-PUR/M12FR

1694512

<https://www.phoenixcontact.com/de/produkte/1694512>

Torque screwdriver

Torque screwdriver - TSD 04 SAC - 1208429

<https://www.phoenixcontact.com/de/produkte/1208429>



Torque screwdriver, with preset torque of 0.4 Nm and 4 mm hexagonal drive for M12 connectors

Torque screwdriver

Torque screwdriver - TSD-M 1,2NM - 1212224

<https://www.phoenixcontact.com/de/produkte/1212224>



Torque screw driver, accuracy as per EN ISO 6789 standard, adjustable from 0.3 - 1.2 Nm

Sensor/actuator cable - SAC-3P- 3,0-PUR/M12FR



1694512

<https://www.phoenixcontact.com/de/produkte/1694512>

Adapter insert

Adapter insert - TSD-M SAC-BIT ADAPTER - 1212600

<https://www.phoenixcontact.com/de/produkte/1212600>



Adapter bit for TSD-M...torque tools, E6.3-1/4" drive with 4 mm hexagon to accommodate SAC bits

Tool

Tool - SAC BIT M12-D15 - 1208432

<https://www.phoenixcontact.com/de/produkte/1208432>



Nut for assembling sensor/actuator cables with M12 connector and M12 connectors for assembly, with a knurl diameter of 15 mm, for 4 mm hexagonal drive

Phoenix Contact 2022 © - all rights reserved
<https://www.phoenixcontact.com>

PHOENIX CONTACT Deutschland GmbH
Flachsmarktstraße 8
D-32825 Blomberg
+49 52 35/3-1 20 00
info@phoenixcontact.de