

Contact insert - HC-A16-I-UT-F

1585320

<https://www.phoenixcontact.com/pc/products/1585320>



Please be informed that the data shown in this PDF document is generated from our Online Catalog. Please find the complete data in the user documentation. Our General Terms of Use for Downloads are valid.

HEAVYCON female insert, A16 series, 16-pos., screw connection

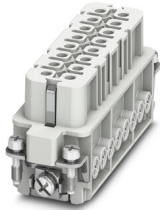

Your advantages

- can be coded with plastic coding profile (order number 1410916)
- For a test pin 2 mm in diameter

Contact insert - HC-A16-I-UT-F



1585320

<https://www.phoenixcontact.com/pc/products/1585320>

Commercial Data

Item number	1585320
Packing unit	1 pc
Minimum order quantity	1 pc
Product Key	BF7ABB
Catalog Page	Page 521 (C-2-2019)
GTIN	4046356285056
Weight per Piece (including packing)	64.4 g
Weight per Piece (excluding packing)	64.016 g
Customs tariff number	85366990
Country of origin	CN

Contact insert - HC-A16-I-UT-F

1585320

<https://www.phoenixcontact.com/pc/products/1585320>

Technical Data

Notes

General	for flexible conductors with or without ferrules
General	Connectors may be operated only when there is no load/voltage.
General	for HC-D25 / HC-D 50 housing

Product properties

Type	D25 D50
Product type	Contact insert with a fixed no. of positions
Number of positions	16
Connection profile	16+PE
Number of connections per position	1
Contact type	turned
Series	HC-A
Screwdriver blade	0.5 x 3.5 mm

Insulation characteristics

Overvoltage category	III
Degree of pollution	3

Connection data

Connection technology

Connection technology	Screw connection
Number of connections per position	1
Connection in acc. with standard	IEC / EN

Conductor connection

Connection cross section AWG	20 ... 14
Tightening torque	0.5 Nm
Stripping length of the individual wire	7 mm

Dimensions

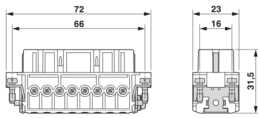
Dimensional drawing	
Width	23 mm
Height	33 mm
Length	72 mm
Drill hole distance, horizontal	66 mm
Drill hole distance, vertical	16 mm

Contact insert - HC-A16-I-UT-F



1585320

<https://www.phoenixcontact.com/pc/products/1585320>

Mechanical characteristics

Contact diameter	2.5 mm
------------------	--------

Electrical properties

Rated voltage (III/3)	250 V
Rated surge voltage	4 kV
Rated surge voltage	4 kV
Rated current	16 A
SCCR	5 kA (UL 2237)

Material specifications

Flammability rating according to UL 94	V0
Contact material	Copper alloy
Contact surface material	Ag
Contact carrier material	PC
Standards/regulations	PC: Fire protection in rail vehicles - requirement sets R22, R23, and R24 acc. to DIN EN 45545-2 (Risk level HL1 - HL3)

Connector

Insertion/withdrawal cycles	≥ 500
-----------------------------	-------

Cable / line

Cable structure

Stripping length of the individual wire	7 mm
---	------

Mounting

Assembly instructions	To ensure correct use, installation in housing with IP54 protection or better is required
	for plastic coding profiles: 4 pcs.

Ambient conditions

Ambient temperature (operation)	-40 °C ... 125 °C (including heating up of contacts)
---------------------------------	--

Standards and regulations

Testing

Standards/regulations	PC: Fire protection in rail vehicles - requirement sets R22, R23, and R24 acc. to DIN EN 45545-2 (Risk level HL1 - HL3)
-----------------------	---

Contact insert - HC-A16-I-UT-F

1585320

<https://www.phoenixcontact.com/pc/products/1585320>

Drawings

Diagram

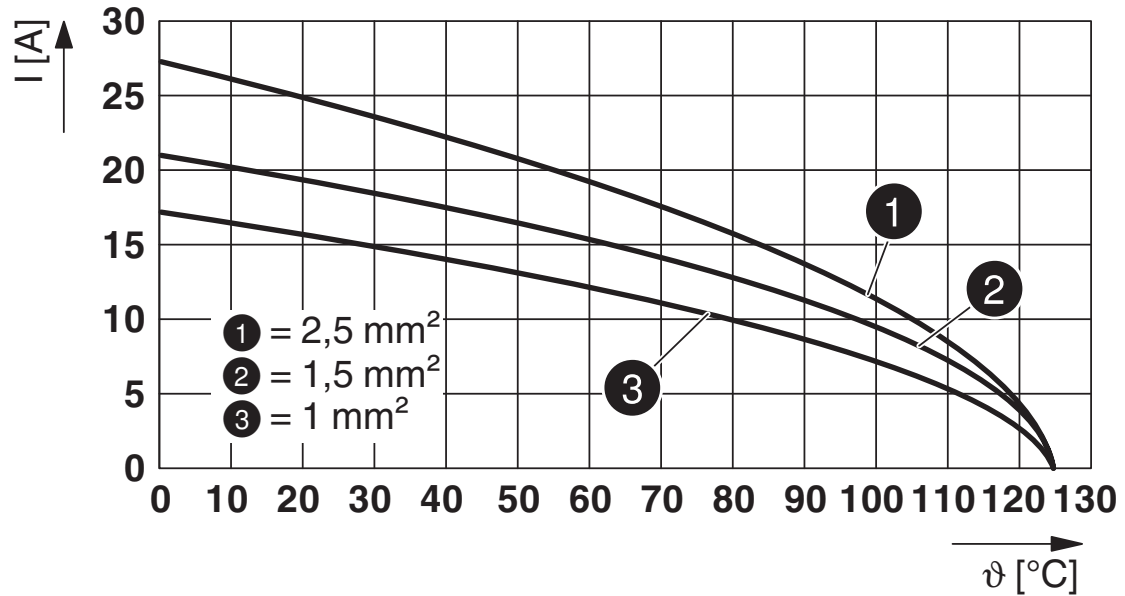

Derating diagram

Dimensional drawing

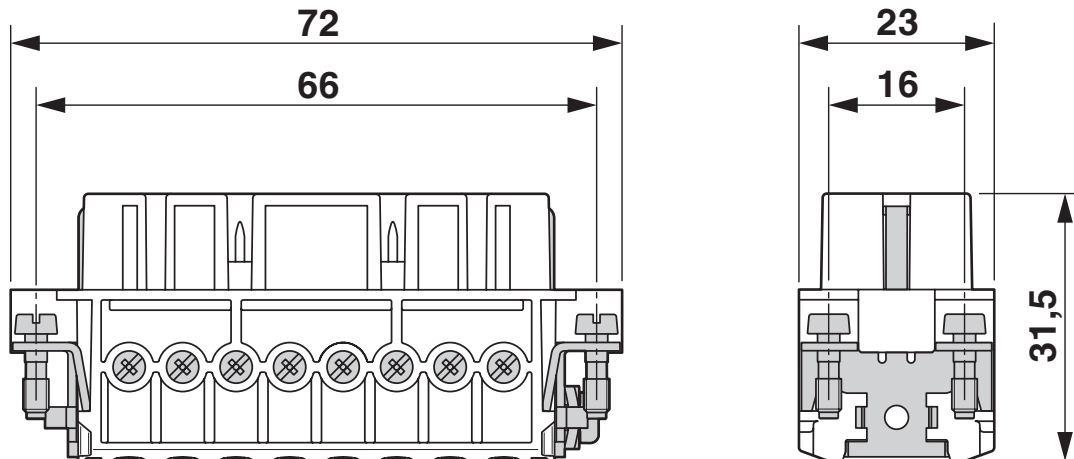

Female insert

Contact insert - HC-A16-I-UT-F

1585320

<https://www.phoenixcontact.com/pc/products/1585320>

Schematic diagram

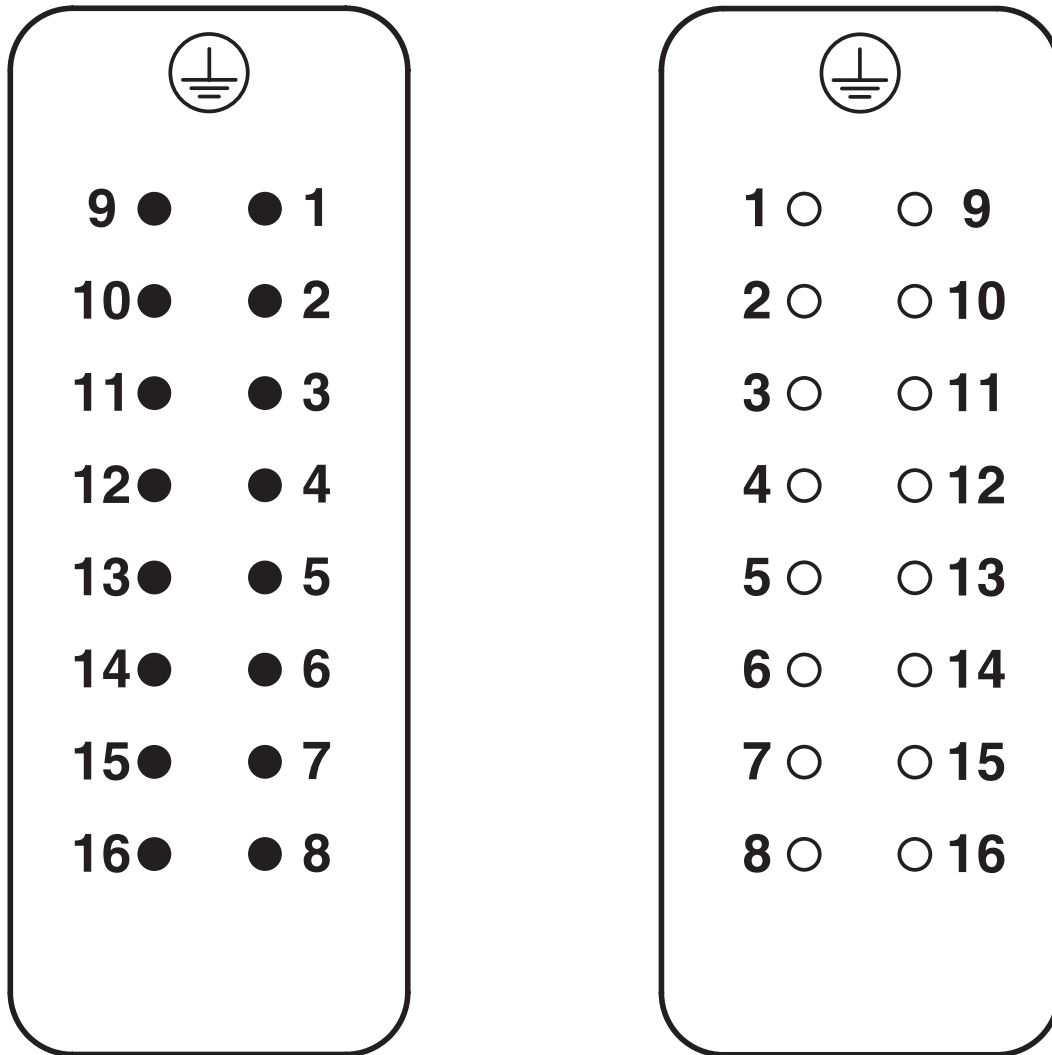

Connector pin assignment, connection side

Contact insert - HC-A16-I-UT-F

1585320

<https://www.phoenixcontact.com/pc/products/1585320>

Dimensional drawing

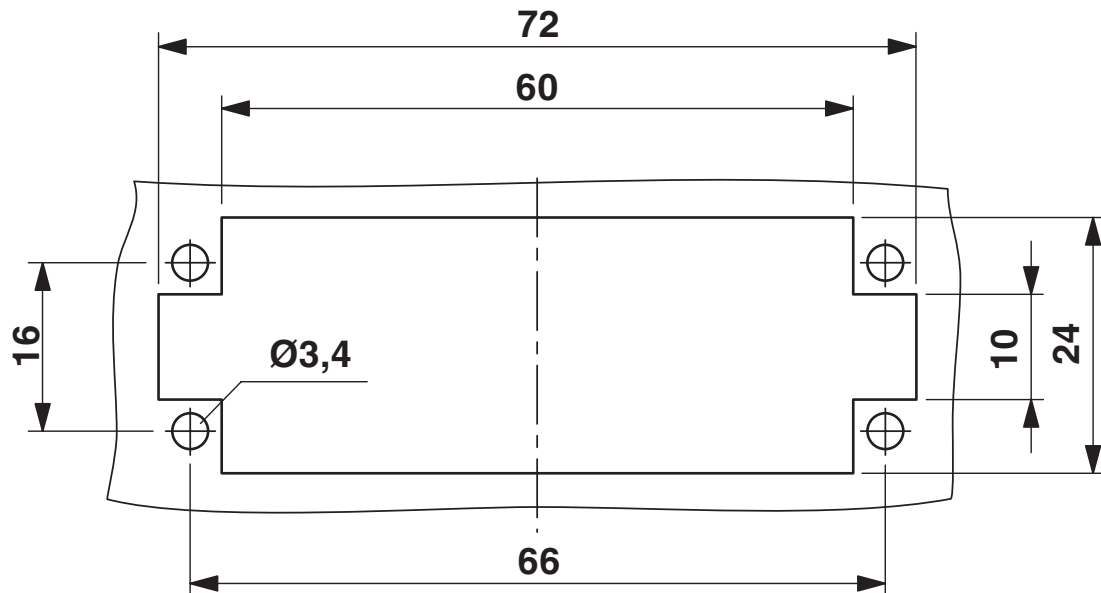

Mounting cutout when used without housing

Contact insert - HC-A16-I-UT-F



1585320

<https://www.phoenixcontact.com/pc/products/1585320>

Approvals

DNV

Approval ID: TAE000037S



CSA

Approval ID: 13631

Nominal Voltage U_N	Nominal Current I_N	Cross Section AWG	Cross Section mm^2
600 V	15 A	- 14	-



UL Recognized

Approval ID: E118976

Nominal Voltage U_N	Nominal Current I_N	Cross Section AWG	Cross Section mm^2
600 V	19 A	-	-



EAC

Approval ID: RU C-DE.AI30.B.01102



UL Recognized

Approval ID: E468743

Nominal Voltage U_N	Nominal Current I_N	Cross Section AWG	Cross Section mm^2
600 V	18 A	-	-



EAC

Approval ID: RU C-DE.BL08.B.00511

Contact insert - HC-A16-I-UT-F



1585320

<https://www.phoenixcontact.com/pc/products/1585320>

Classifications

ECLASS

ECLASS-9.0	27440205
ECLASS-10.0.1	27440205
ECLASS-11.0	27440205

ETIM

ETIM 8.0	EC000438
----------	----------

UNSPSC

UNSPSC 21.0	39121500
-------------	----------

Contact insert - HC-A16-I-UT-F



1585320

<https://www.phoenixcontact.com/pc/products/1585320>

Environmental Product Compliance

REACH SVHC	Lead 7439-92-1
China RoHS	Environmentally Friendly Use Period = 50 years
	For information on hazardous substances, refer to the manufacturer's declaration available under "Downloads"

Contact insert - HC-A16-I-UT-F

1585320

<https://www.phoenixcontact.com/pc/products/1585320>



Accessories

Coding bolt

Coding bolt - HC-CB - 1772722

<https://www.phoenixcontact.com/pc/products/1772722>



Coding pin, prevents mismatching of up to six connectors with an identical number of positions

Screw

Screw - HC-A-PES - 1584868

<https://www.phoenixcontact.com/pc/products/1584868>



PE screw for contact inserts of A series

Contact insert - HC-A16-I-UT-F

1585320

<https://www.phoenixcontact.com/pc/products/1585320>



Contact insert

Contact insert - HC-A16-I-UT-M - 1585317

<https://www.phoenixcontact.com/pc/products/1585317>

HEAVYCON pin insert, A16 series, 16-pos., screw connection

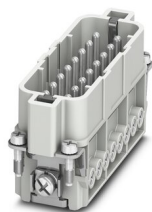

Adapter

Adapter - HC-A-PE-PT - 1054712

<https://www.phoenixcontact.com/pc/products/1054712>

PE adapter with PT connection, for 1 PE connection, for HC-A10 / HC-A16 / HC-D15 / HC-D25 series contact inserts



Contact insert - HC-A16-I-UT-F

1585320

<https://www.phoenixcontact.com/pc/products/1585320>



Coding element

Coding element - HC-CST - 1676857

<https://www.phoenixcontact.com/pc/products/1676857>



Coding peg for coding up to 16 connectors

Coding element

Coding element - HC-CBU - 1676860

<https://www.phoenixcontact.com/pc/products/1676860>



Coding socket for coding up to 16 connectors

Contact insert - HC-A16-I-UT-F

1585320

<https://www.phoenixcontact.com/pc/products/1585320>



Coding profile

Coding profile - CP-HC-S - 1410916

<https://www.phoenixcontact.com/pc/products/1410916>

Coding profile, 4 elements per star, for insertion in a coding keyway, for contact inserts HC-BB... / HC-A10-I-UT... / HC-A16-I-UT...



Phoenix Contact 2022 © - all rights reserved

<https://www.phoenixcontact.com>

PHOENIX CONTACT GmbH & Co. KG

Flachsmarktstraße 8

D-32825 Blomberg

+49 (0) 5235-3 00

info@phoenixcontact.com