

Connector - SACC-M12MS-4CON-PG9-M



1523230

<https://www.phoenixcontact.com/pc/products/1523230>

Please be informed that the data shown in this PDF document is generated from our Online Catalog. Please find the complete data in the user documentation. Our General Terms of Use for Downloads are valid.



Connector, 4-position, Plug straight M12, Coding: A, Screw connection, knurl material: Zinc die-cast, nickel-plated, cable gland Pg9, external cable diameter 6 mm ... 8 mm

Your advantages

- Safe use in the field, thanks to a high degree of protection
- Screw connection: proven connection technology for a large selection of different conductors

Connector - SACC-M12MS-4CON-PG9-M



1523230

<https://www.phoenixcontact.com/pc/products/1523230>

Commercial Data

Item number	1523230
Packing unit	1 pc
Minimum order quantity	1 pc
Product Key	BF2CAA
Catalog Page	Page 22 (C-2-2019)
GTIN	4017918984847
Weight per Piece (including packing)	23.12 g
Weight per Piece (excluding packing)	22.76 g
Customs tariff number	85366990
Country of origin	DE

Technical Data

Notes

Assembly instruction:	NOTE: Observe the permissible bending radii when laying conductors, since the degree of protection may be put in jeopardy if the bending forces are too high. Alleviate mechanical loads upstream of the connector, e.g. by using cable ties.
-----------------------	--

Product properties

Number of positions	4
No. of cable outlets	1
Shielded	no
Coding	A - standard
Cable outlet	straight
Pg screw connection	Pg9

Insulation characteristics

Overvoltage category	II
Degree of pollution	3

Electrical properties

Rated surge voltage	2.5 kV
Contact resistance	≤ 8 mΩ
Insulation resistance	≥ 100 MΩ
Nominal voltage U_N	250 V DC 250 V AC
Nominal current I_N	4 A

LED signaling

Status display	No
Status display present	No

Dimensions

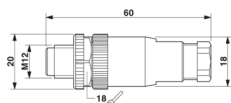
Dimensional drawing	
Length	60 mm

External dimensions

Outside diameter	6 mm ... 8 mm
------------------	---------------

Housing

Diameter housing	20 mm
------------------	-------

Connector - SACC-M12MS-4CON-PG9-M



1523230

<https://www.phoenixcontact.com/pc/products/1523230>

Material specifications

Flammability rating according to UL 94	HB
Sealing material	NBR
Material of grip body	PA
Contact material	CuZn
Contact surface material	CuSnZn
Contact carrier material	PA
Cable gland material	Zinc die-cast, nickel-plated

Connector

Insertion/withdrawal cycles	≥ 50
-----------------------------	------

Header 1

Head design	Plug
Head cable outlet	straight
Head thread type	M12
Coding	A-coded
Number of positions	4
Coding	A - standard
Insertion/withdrawal cycles	≥ 50
Connection method	Screw connection
Contact material	CuZn
Contact surface material	CuSnZn
Number of positions	4
Coding	A - standard
Insertion/withdrawal cycles	≥ 50
Connection method	Screw connection
Contact material	CuZn
Contact surface material	CuSnZn

Cable / line

Cable structure

Stripping length of the individual wire	5 mm
---	------

Environmental and real-life conditions

Ambient conditions

Degree of protection	IP67
Ambient temperature (operation)	-40 °C ... 85 °C (Plug / socket)

Standards and regulations

Standards/specifications	IEC 61076-2-101
--------------------------	-----------------

Connector - SACC-M12MS-4CON-PG9-M

1523230

<https://www.phoenixcontact.com/pc/products/1523230>

Drawings

Schematic diagram

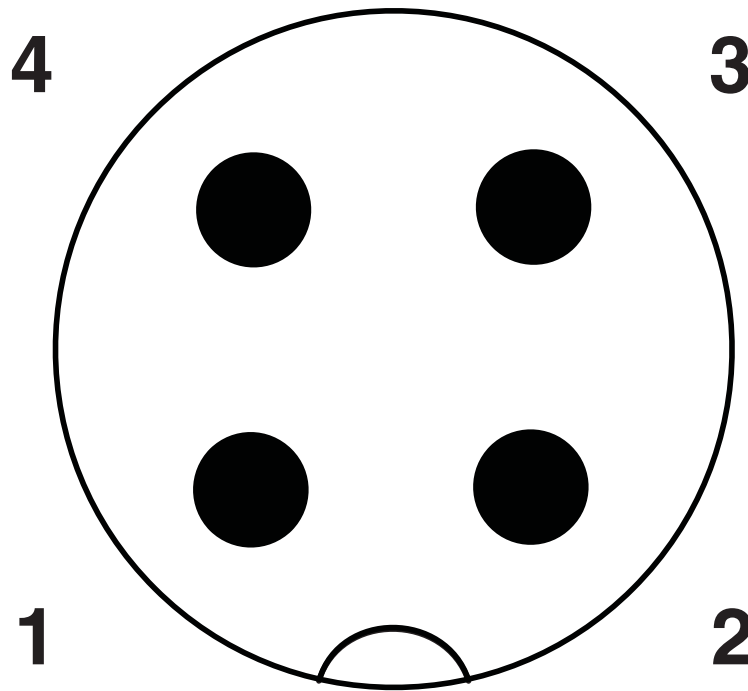

Pin assignment M12 plug, 4-pos., A-coded, view plug side

Dimensional drawing

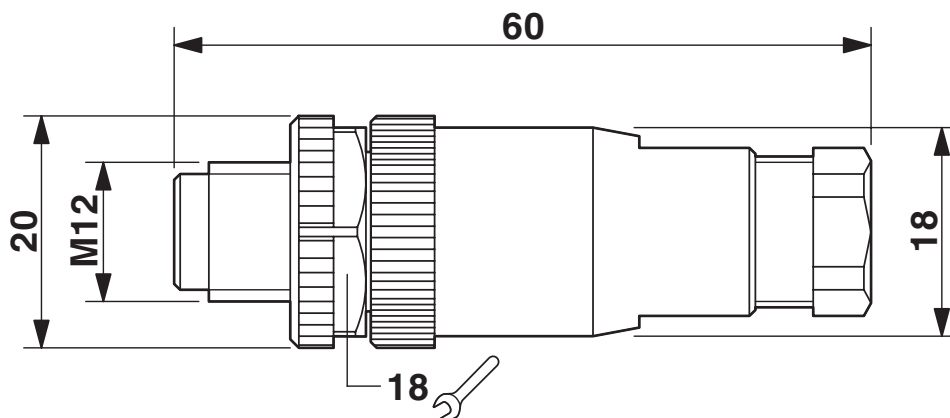

Plug, M12 x 1, straight

Connector - SACC-M12MS-4CON-PG9-M

1523230

<https://www.phoenixcontact.com/pc/products/1523230>



Schematic diagram

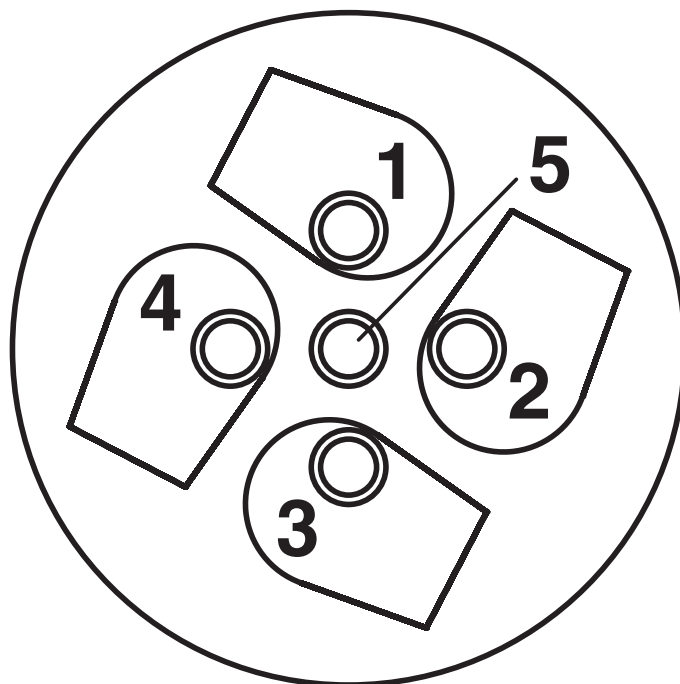

Cable connection side M12 (screw connection)

Connector - SACC-M12MS-4CON-PG9-M





1523230

<https://www.phoenixcontact.com/pc/products/1523230>

Approvals

 cUL Recognized				
	Nominal Voltage U_N	Nominal Current I_N	Cross Section AWG	Cross Section mm^2
	250 V	4 A	-	-

 UL Recognized				
	Nominal Voltage U_N	Nominal Current I_N	Cross Section AWG	Cross Section mm^2
	250 V	4 A	-	-

 EAC				
---	--	--	--	--

cULus Recognized				
------------------	--	--	--	--

Connector - SACC-M12MS-4CON-PG9-M



1523230

<https://www.phoenixcontact.com/pc/products/1523230>

Classifications

ECLASS

ECLASS-10.0.1	27440102
ECLASS-9.0	27440102
ECLASS-11.0	27440102

ETIM

ETIM 8.0	EC002635
----------	----------

UNSPSC

UNSPSC 21.0	39121400
-------------	----------

Connector - SACC-M12MS-4CON-PG9-M



1523230

<https://www.phoenixcontact.com/pc/products/1523230>

Environmental Product Compliance

REACH SVHC	Lead 7439-92-1
China RoHS	Environmentally Friendly Use Period = 50 years
	For information on hazardous substances, refer to the manufacturer's declaration available under "Downloads"

Connector - SACC-M12MS-4CON-PG9-M



1523230

<https://www.phoenixcontact.com/pc/products/1523230>

Accessories

Cable reel

Cable reel - SAC-4P-100,0-PUR/0,25 - 1501692

<https://www.phoenixcontact.com/pc/products/1501692>



By the meter, Cable reel, PUR halogen-free, black-gray RAL 7021, 4-wire, color single wire: brown, white, blue, black, cable length: 100 m

Cable reel

Cable reel - SAC-4P-100,0-PUR/0,34 - 1501663

<https://www.phoenixcontact.com/pc/products/1501663>



By the meter, Cable reel, PUR halogen-free, black-gray RAL 7021, 4-wire, color single wire: brown, white, blue, black, cable length: 100 m

Connector - SACC-M12MS-4CON-PG9-M

1523230

<https://www.phoenixcontact.com/pc/products/1523230>

Cable reel

Cable reel - SAC-4P-100,0-186/0,75 - 1457461

<https://www.phoenixcontact.com/pc/products/1457461>



By the meter, Cable reel, PUR, black-gray RAL 7021, 4-wire, color single wire: brown, white, blue, black, cable length: 100 m

Connector

Connector - SACC-M12-SET/2,5-3,5 - 1436505

<https://www.phoenixcontact.com/pc/products/1436505>



Sensor/actuator connector, accessories, pressure screw and Pg7 seal, for unshielded M12 connector, cable diameter 2.5 mm - 3.5 mm

Connector - SACC-M12MS-4CON-PG9-M



1523230

<https://www.phoenixcontact.com/pc/products/1523230>

Screwdriver

Screwdriver - SZF 1-0,6X3,5 - 1204517

<https://www.phoenixcontact.com/pc/products/1204517>



Actuation tool, for ST terminal blocks, also suitable for use as a bladed screwdriver, size: 0.6 x 3.5 x 100 mm, 2-component grip, with non-slip grip

Ferrule

Ferrule - A 0,25- 5 - 3202465

<https://www.phoenixcontact.com/pc/products/3202465>



Ferrule, length: 5 mm, color: silver

Connector - SACC-M12MS-4CON-PG9-M



1523230

<https://www.phoenixcontact.com/pc/products/1523230>

Torque screwdriver

Torque screwdriver - TSD 04 SAC - 1208429

<https://www.phoenixcontact.com/pc/products/1208429>



Torque screwdriver, with preset torque of 0.4 Nm and 4 mm hexagonal drive for M12 connectors

Torque screwdriver

Torque screwdriver - TSD-M 1,2NM - 1212224

<https://www.phoenixcontact.com/pc/products/1212224>



Torque screw driver, accuracy as per EN ISO 6789 standard, adjustable from 0.3 - 1.2 Nm

Connector - SACC-M12MS-4CON-PG9-M



1523230

<https://www.phoenixcontact.com/pc/products/1523230>

Adapter insert

Adapter insert - TSD-M SAC-BIT ADAPTER - 1212600

<https://www.phoenixcontact.com/pc/products/1212600>



Adapter bit for TSD-M...torque tools, E6.3-1/4" drive with 4 mm hexagon to accommodate SAC bits

Sealing cap

Sealing cap - PROT-M12 FS-PA-CHAIN - 1430873

<https://www.phoenixcontact.com/pc/products/1430873>



M12 sealing cap made of plastic with fixing band, for sensor cables, for free M12 plugs

Connector - SACC-M12MS-4CON-PG9-M



1523230

<https://www.phoenixcontact.com/pc/products/1523230>

Crimping pliers

Crimping pliers - CRIMPFOX 6H - 1212046

<https://www.phoenixcontact.com/pc/products/1212046>



Crimping pliers, for ferrules without insulating collar according to DIN 46228 Part 1 and ferrules with insulating collar according to DIN 46228 Part 4, 0.14 mm² ... 6 mm², unlockable pressure lock, lateral entry

Tool

Tool - SACC BIT M12-D20 - 1208445

<https://www.phoenixcontact.com/pc/products/1208445>



Nut for assembling M12 connectors for assembly with a knurl diameter of 20 mm, for 4 mm hexagonal drive

Phoenix Contact 2022 © - all rights reserved
<https://www.phoenixcontact.com>

PHOENIX CONTACT GmbH & Co. KG
Flachsmarktstraße 8
D-32825 Blomberg
+49 (0) 5235-3 00
info@phoenixcontact.com