

# Test disconnect terminal block - UTME 4

3047452

<https://www.phoenixcontact.com/de/produkte/3047452>

Please be informed that the data shown in this PDF document is generated from our Online Catalog. Please find the complete data in the user documentation. Our General Terms of Use for Downloads are valid.

---

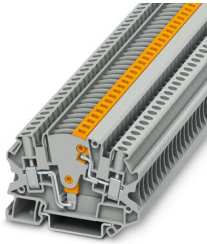

Test disconnect terminal block, nom. voltage: 500 V, Thermal continuous current  $I_{th}$ : 28 A, connection method: Screw connection, Rated cross section: 4 mm<sup>2</sup>, cross section: 0.14 mm<sup>2</sup> - 6 mm<sup>2</sup>, mounting: NS 35/7,5, NS 35/15, color: gray

---

## Your advantages

- Compact design

# Test disconnect terminal block - UTME 4



3047452

<https://www.phoenixcontact.com/de/produkte/3047452>

## Commercial Data

Item number	3047452
Packing unit	50 pc
Minimum order quantity	1 pc
Sales Key	A1 - Reihenklennen
Product Key	BE1133
Catalog Page	Page 169 (C-1-2019)
GTIN	4046356511384
Weight per Piece (including packing)	15,24 g
Weight per Piece (excluding packing)	15,24 g
Customs tariff number	85369010
Country of origin	PL

# Test disconnect terminal block - UTME 4



3047452

<https://www.phoenixcontact.com/de/produkte/3047452>

## Technical Data

### Notes

#### General

Note	The max. load current must not be exceeded by the total current of all connected conductors.
------	--

### Product properties

Product type	Test disconnect terminal block
Number of connections	2
Number of rows	1
Potentials	1

#### Insulation characteristics

Overvoltage category	III
----------------------	-----

### Electrical properties

Rated surge voltage	6 kV
Maximum power dissipation for nominal condition	1.02 W

### Connection data

Number of connections per level	2
Nominal cross section	4 mm <sup>2</sup>

#### Level 1 above 1 below 1

Screw thread	M3
Tightening torque	0.6 ... 0.8 Nm
Stripping length	9 mm
Internal cylindrical gage	A4
Conductor cross section solid	0.14 mm <sup>2</sup> ... 6 mm <sup>2</sup>
Cross section AWG	26 ... 10
Conductor cross section flexible	0.14 mm <sup>2</sup> ... 6 mm <sup>2</sup>
Conductor cross section, flexible [AWG]	26 ... 10
Flexible conductor cross section flexible (ferrule, w/o plastic sleeve)	0.14 mm <sup>2</sup> ... 4 mm <sup>2</sup>
Flexible conductor cross section (ferrule with plastic sleeve)	0.14 mm <sup>2</sup> ... 4 mm <sup>2</sup>
2 conductors with same cross section, solid	0.14 mm <sup>2</sup> ... 1.5 mm <sup>2</sup>
2 conductors with same cross section, flexible	0.14 mm <sup>2</sup> ... 1.5 mm <sup>2</sup>
2 conductors with same cross section, flexible, with ferrule without plastic sleeve	0.14 mm <sup>2</sup> ... 1.5 mm <sup>2</sup>
2 conductors with the same cross section, flexible, with TWIN ferrule with plastic sleeve	0.5 mm <sup>2</sup> ... 2.5 mm <sup>2</sup>
Maximum load current	28 A
Nominal voltage	500 V
Nominal cross section	4 mm <sup>2</sup>

# Test disconnect terminal block - UTME 4



3047452

<https://www.phoenixcontact.com/de/produkte/3047452>

## Dimensions

Width	6.2 mm
End cover width	2.2 mm
Height NS 35/15	57 mm
Height NS 35/7,5	49.5 mm
Length	66 mm

## Material specifications

Color	gray
Flammability rating according to UL 94	V0
Insulating material group	I
Insulating material	PA
Static insulating material application in cold	-60 °C
Temperature index of insulation material (DIN EN 60216-1 (VDE 0304-21))	130 °C
Relative insulation material temperature index (Elec., UL 746 B)	130 °C
Fire protection for rail vehicles (DIN EN 45545-2) R22	HL 1 - HL 3
Fire protection for rail vehicles (DIN EN 45545-2) R23	HL 1 - HL 3
Fire protection for rail vehicles (DIN EN 45545-2) R24	HL 1 - HL 3
Fire protection for rail vehicles (DIN EN 45545-2) R26	HL 1 - HL 3
Calorimetric heat release NFPA 130 (ASTM E 1354)	28 MJ/kg
Surface flammability NFPA 130 (ASTM E 162)	passed
Specific optical density of smoke NFPA 130 (ASTM E 662)	passed
Smoke gas toxicity NFPA 130 (SMP 800C)	passed

## Electrical tests

### Surge voltage test

Result	Test passed
--------	-------------

### Temperature-rise test

Requirement temperature-rise test	Increase in temperature $\leq$ 45 K
Result	Test passed
Short-time withstand current 4 mm <sup>2</sup>	0.48 kA
	0.15 kA
	1.25 kA
Result	Test passed

### Power-frequency withstand voltage

Test voltage setpoint	1.89 kV
Result	Test passed

## Mechanical properties

### Mechanical data

Open side panel	Yes
-----------------	-----

# Test disconnect terminal block - UTME 4



3047452

<https://www.phoenixcontact.com/de/produkte/3047452>

## Mechanical tests

### Mechanical strength

Result	Test passed
--------	-------------

### Attachment on the carrier

DIN rail/fixing support	NS 35
Result	Test passed

### Test for conductor damage and slackening

Rotation speed	10 rpm
Revolutions	135
Conductor cross section/weight	0.2 mm <sup>2</sup> / 0.2 kg
	4 mm <sup>2</sup> / 0.9 kg
	6 mm <sup>2</sup> / 1.4 kg
Result	Test passed

## Environmental and real-life conditions

### Aging

Result	Test passed
--------	-------------

### Needle-flame test

Time of exposure	30 s
------------------	------

### Oscillation/broadband noise

Specification	DIN EN 50155 (VDE 0115-200):2018-05
Spectrum	Service life test category 2, bogie-mounted
Frequency	$f_1 = 5 \text{ Hz}$ to $f_2 = 250 \text{ Hz}$
ASD level	6.12 (m/s <sup>2</sup> ) <sup>2</sup> /Hz
Acceleration	3.12g
Test duration per axis	5 h
Test directions	X-, Y- and Z-axis

### Shocks

Specification	DIN EN 50155 (VDE 0115-200):2008-03
Pulse shape	Semi-sinusoidal
Acceleration	30g
Shock duration	18 ms
Number of shocks per direction	3
Test directions	X-, Y- and Z-axis (pos. and neg.)

### Ambient conditions

Ambient temperature (operation)	-60 °C ... 105 °C (max. short-term operating temperature RTI Elec.)
Ambient temperature (storage/transport)	-25 °C ... 60 °C (for a short time, not exceeding 24 h, -60 °C to +70 °C)
Ambient temperature (assembly)	-5 °C ... 70 °C

# Test disconnect terminal block - UTME 4



3047452

<https://www.phoenixcontact.com/de/produkte/3047452>

Ambient temperature (actuation)	-5 °C ... 70 °C
Permissible humidity (storage/transport)	30 % ... 70 %

## Standards and regulations

Connection in acc. with standard	IEC 60947-7-1
----------------------------------	---------------

## Mounting

Mounting type	NS 35/7,5
	NS 35/15

# Test disconnect terminal block - UTME 4

3047452

<https://www.phoenixcontact.com/de/produkte/3047452>

## Drawings

Circuit diagram



Circuit diagram

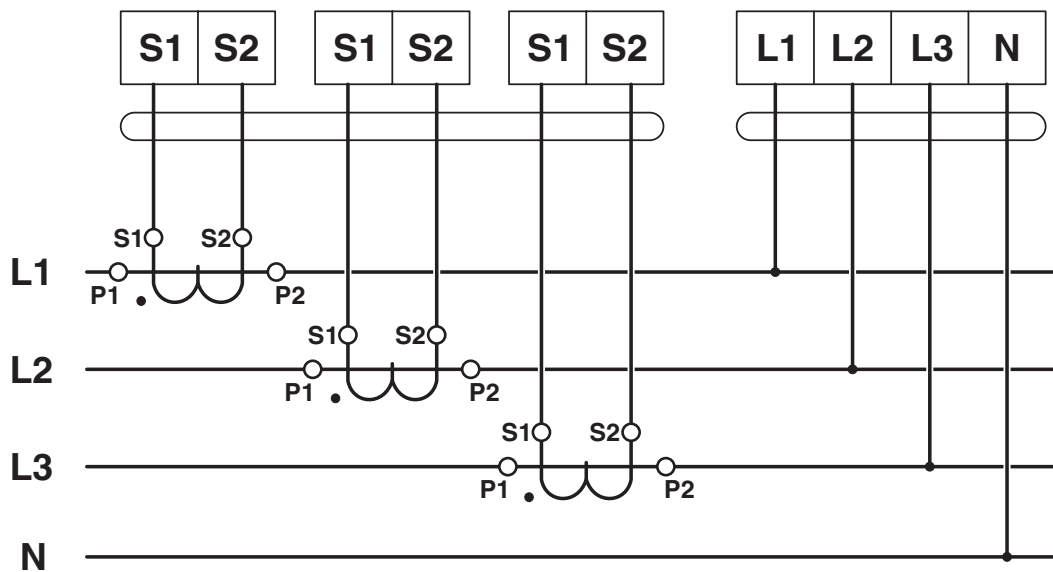

# Test disconnect terminal block - UTME 4

3047452

<https://www.phoenixcontact.com/de/produkte/3047452>

Circuit diagram

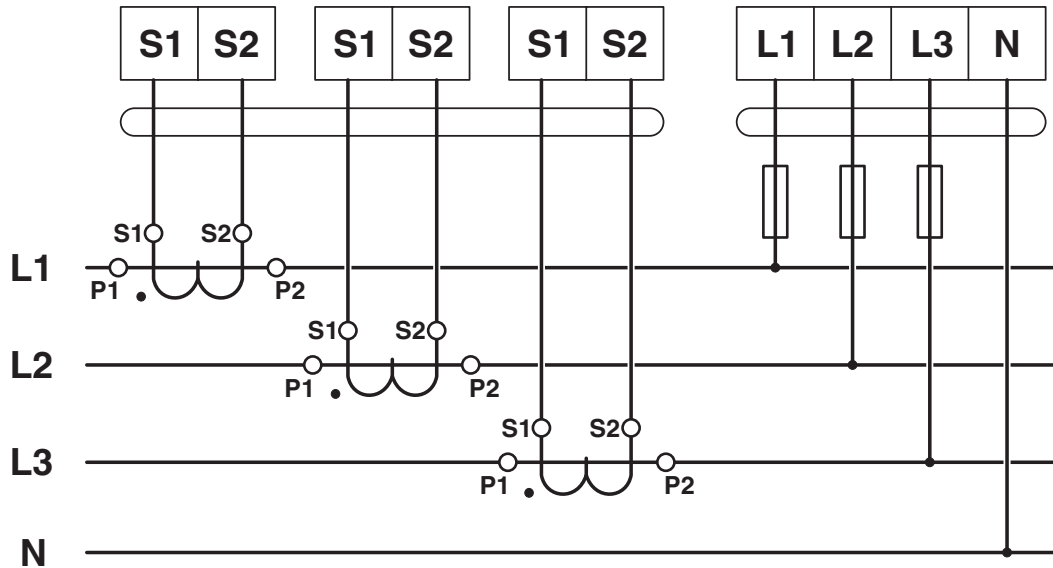



# Test disconnect terminal block - UTME 4





3047452

<https://www.phoenixcontact.com/de/produkte/3047452>

## Approvals

 <b>CSA</b> Approval ID: 13631				
	Nominal Voltage $U_N$	Nominal Current $I_N$	Cross Section AWG	Cross Section $\text{mm}^2$
Use group B	300 V	25 A	26 - 10	-
Use group C	300 V	25 A	26 - 10	-
Use group D	600 V	5 A	26 - 10	-

 <b>EAC</b> Approval ID: RU C-DE.AI30.B.01102				
---	--	--	--	--

 <b>cULus Recognized</b> Approval ID: E60425				
	Nominal Voltage $U_N$	Nominal Current $I_N$	Cross Section AWG	Cross Section $\text{mm}^2$
Use group B	300 V	25 A	26 - 10	-
Use group C	300 V	25 A	26 - 10	-
Use group D	600 V	5 A	26 - 10	-

 <b>EAC</b> Approval ID: RU C-DE.BL08.B.00534				
---	--	--	--	--

# Test disconnect terminal block - UTME 4



3047452

<https://www.phoenixcontact.com/de/produkte/3047452>

## Classifications

### ECLASS

ECLASS-9.0	27141126
ECLASS-10.0.1	27141126
ECLASS-11.0	27141126

### ETIM

ETIM 8.0	EC000902
----------	----------

### UNSPSC

UNSPSC 21.0	39121400
-------------	----------

# Test disconnect terminal block - UTME 4



3047452

<https://www.phoenixcontact.com/de/produkte/3047452>

## Environmental Product Compliance

REACH SVHC	Lead 7439-92-1
China RoHS	Environmentally Friendly Use Period = 50 years
	For information on hazardous substances, refer to the manufacturer's declaration available under "Downloads"

# Test disconnect terminal block - UTME 4

3047452

<https://www.phoenixcontact.com/de/produkte/3047452>

## Accessories

 Note: Applying some accessories below might limit this product.

### Plug-in bridge

Plug-in bridge - FBS 20-6 - 3030365

<https://www.phoenixcontact.com/de/produkte/3030365>



Plug-in bridge, pitch: 6.2 mm, color: red

 Max. current carrying capacity: 28 A

---

### Plug-in bridge

Plug-in bridge - FBS 10-6 - 3030271

<https://www.phoenixcontact.com/de/produkte/3030271>



Plug-in bridge, pitch: 6.2 mm, color: red

 Max. current carrying capacity: 28 A

# Test disconnect terminal block - UTME 4

3047452

<https://www.phoenixcontact.com/de/produkte/3047452>

## Plug-in bridge

Plug-in bridge - FBS 5-6 - 3030349

<https://www.phoenixcontact.com/de/produkte/3030349>



Plug-in bridge, pitch: 6.2 mm, color: red

 Max. current carrying capacity: 28 A

---

## Plug-in bridge

Plug-in bridge - FBS 4-6 - 3030255

<https://www.phoenixcontact.com/de/produkte/3030255>



Plug-in bridge, pitch: 6.2 mm, color: red

 Max. current carrying capacity: 28 A

---

# Test disconnect terminal block - UTME 4

3047452

<https://www.phoenixcontact.com/de/produkte/3047452>

## Plug-in bridge

Plug-in bridge - FBS 3-6 - 3030242

<https://www.phoenixcontact.com/de/produkte/3030242>



Plug-in bridge, pitch: 6.2 mm, color: red

 Max. current carrying capacity: 28 A

---

## Plug-in bridge

Plug-in bridge - FBS 2-6 - 3030336

<https://www.phoenixcontact.com/de/produkte/3030336>



Plug-in bridge, pitch: 6.2 mm, color: red

 Max. current carrying capacity: 28 A

# Test disconnect terminal block - UTME 4

3047452

<https://www.phoenixcontact.com/de/produkte/3047452>



## Plug-in bridge

Plug-in bridge - FBS 50-6 - 3032224

<https://www.phoenixcontact.com/de/produkte/3032224>



Plug-in bridge, pitch: 6.2 mm, color: red

 Max. current carrying capacity: 28 A

The nominal voltage of the jumper is 400 V

---

## Switching jumper

Switching jumper - SB-ME 2-6 - 3035755

<https://www.phoenixcontact.com/de/produkte/3035755>



Switching jumper, pitch: 6.2 mm, color: gray/orange

 Max. current carrying capacity: 25 A

# Test disconnect terminal block - UTME 4

3047452

<https://www.phoenixcontact.com/de/produkte/3047452>



## Switching jumper

Switching jumper - SB-ME 3-6 - 3035756

<https://www.phoenixcontact.com/de/produkte/3035756>



Switching jumper, pitch: 6.2 mm, color: gray/orange

 Max. current carrying capacity: 25 A

---

## Switching jumper

Switching jumper - SB-ME 4-6 - 3035757

<https://www.phoenixcontact.com/de/produkte/3035757>



Switching jumper, pitch: 6.2 mm, color: gray/orange

 Max. current carrying capacity: 25 A



# Test disconnect terminal block - UTME 4

3047452

<https://www.phoenixcontact.com/de/produkte/3047452>

## Plug-in bridge

Plug-in bridge - FBSR 2-6 - 3033715

<https://www.phoenixcontact.com/de/produkte/3033715>



Plug-in bridge, pitch: 6.2 mm, color: red

 Max. current carrying capacity: 28 A

---

## Plug-in bridge

Plug-in bridge - FBSR 3-6 - 3001594

<https://www.phoenixcontact.com/de/produkte/3001594>



Plug-in bridge, pitch: 6.2 mm, color: red

 Max. current carrying capacity: 28 A

---

# Test disconnect terminal block - UTME 4

3047452

<https://www.phoenixcontact.com/de/produkte/3047452>

## Plug-in bridge

Plug-in bridge - FBSR 4-6 - 3001595

<https://www.phoenixcontact.com/de/produkte/3001595>



Plug-in bridge, pitch: 6.2 mm, color: red

 Max. current carrying capacity: 28 A

---

## Plug-in bridge

Plug-in bridge - FBSR 5-6 - 3001596

<https://www.phoenixcontact.com/de/produkte/3001596>



Plug-in bridge, pitch: 6.2 mm, color: red

 Max. current carrying capacity: 28 A

---

# Test disconnect terminal block - UTME 4

3047452

<https://www.phoenixcontact.com/de/produkte/3047452>



## Plug-in bridge

Plug-in bridge - FBSR 10-6 - 3033716

<https://www.phoenixcontact.com/de/produkte/3033716>



Plug-in bridge, pitch: 6.2 mm, color: red

 Max. current carrying capacity: 28 A

---

## Short-circuit connector

Short-circuit connector - FBSRH 2-6 - 3033812

<https://www.phoenixcontact.com/de/produkte/3033812>



Short-circuit connector, pitch: 6.2 mm, color: red

 Max. current carrying capacity: 28 A

# Test disconnect terminal block - UTME 4

3047452

<https://www.phoenixcontact.com/de/produkte/3047452>

## Plug-in bridge

Plug-in bridge - FBS 2-6 BU - 3036932

<https://www.phoenixcontact.com/de/produkte/3036932>



Plug-in bridge, pitch: 6.2 mm, color: blue

 Max. current carrying capacity: 28 A

---

## Plug-in bridge

Plug-in bridge - FBS 3-6 BU - 3036945

<https://www.phoenixcontact.com/de/produkte/3036945>



Plug-in bridge, pitch: 6.2 mm, color: blue

 Max. current carrying capacity: 28 A

---

# Test disconnect terminal block - UTME 4

3047452

<https://www.phoenixcontact.com/de/produkte/3047452>



## Plug-in bridge

Plug-in bridge - FBS 4-6 BU - 3036958

<https://www.phoenixcontact.com/de/produkte/3036958>



Plug-in bridge, pitch: 6.2 mm, color: blue

 Max. current carrying capacity: 28 A

---

## Plug-in bridge

Plug-in bridge - FBS 5-6 BU - 3036961

<https://www.phoenixcontact.com/de/produkte/3036961>



Plug-in bridge, pitch: 6.2 mm, color: blue

 Max. current carrying capacity: 28 A

# Test disconnect terminal block - UTME 4

3047452

<https://www.phoenixcontact.com/de/produkte/3047452>

## Plug-in bridge

Plug-in bridge - FBS 10-6 BU - 3032198

<https://www.phoenixcontact.com/de/produkte/3032198>

Plug-in bridge, pitch: 6.2 mm, color: blue



 Max. current carrying capacity: 28 A

---

## Plug-in bridge

Plug-in bridge - FBS 20-6 BU - 3032208

<https://www.phoenixcontact.com/de/produkte/3032208>

Plug-in bridge, pitch: 6.2 mm, color: blue

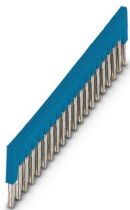

 Max. current carrying capacity: 28 A

# Test disconnect terminal block - UTME 4

3047452

<https://www.phoenixcontact.com/de/produkte/3047452>

## Plug-in bridge

Plug-in bridge - FBS 50-6 BU - 3032211

<https://www.phoenixcontact.com/de/produkte/3032211>



Plug-in bridge, pitch: 6.2 mm, color: blue

 Max. current carrying capacity: 28 A

---

## Screwdriver

Screwdriver - SZF 1-0,6X3,5 - 1204517

<https://www.phoenixcontact.com/de/produkte/1204517>



Actuation tool, for ST terminal blocks, also suitable for use as a bladed screwdriver, size: 0.6 x 3.5 x 100 mm, 2-component grip, with non-slip grip

# Test disconnect terminal block - UTME 4

3047452

<https://www.phoenixcontact.com/de/produkte/3047452>

## DIN rail perforated

DIN rail perforated - NS 35/ 7,5 PERF 2000MM - 0801733

<https://www.phoenixcontact.com/de/produkte/0801733>



DIN rail perforated, acc. to EN 60715, material: Steel, galvanized, passivated with a thick layer, Standard profile, color: silver, Pack of 25 (50 m)

---

## Group marker label for terminal marking

Group marker label for terminal marking - GBS 5-25X12 - 0810588

<https://www.phoenixcontact.com/de/produkte/0810588>



Group marker label, snaps onto terminal center for screw, spring-cage and quick connection terminal blocks, labeled with a 25 x 12 mm label or manually with the B-STIFT, in the foot part with ZB 5



# Test disconnect terminal block - UTME 4

3047452

<https://www.phoenixcontact.com/de/produkte/3047452>

## DIN rail, unperforated

DIN rail, unperforated - NS 35/ 7,5 UNPERF 2000MM - 0801681

<https://www.phoenixcontact.com/de/produkte/0801681>



DIN rail, unperforated, acc. to EN 60715, material: Steel, galvanized, passivated with a thick layer, Standard profile, color: silver, Pack of 25 (50 m)

---

## Group marker label for terminal marking

Group marker label for terminal marking - GBS-ZB/26X6 - 0809298

<https://www.phoenixcontact.com/de/produkte/0809298>



Group marking label, snaps onto terminal center for screw, spring-cage and quick connection terminal blocks, labeled with ESL 26x6 mm or EST 25x6 mm, in the foot part with Zack marker strip, length: 29 mm

# Test disconnect terminal block - UTME 4

3047452

<https://www.phoenixcontact.com/de/produkte/3047452>

## DIN rail perforated

DIN rail perforated - NS 35/ 7,5 WH PERF 2000MM - 1204119

<https://www.phoenixcontact.com/de/produkte/1204119>



DIN rail perforated, acc. to EN 60715, material: Steel, Galvanized, white passivated, Standard profile, color: silver, Pack of 25 (50 m)

---

## Marker carriers

Marker carriers - CARRIER-TM 300 - 0828282

<https://www.phoenixcontact.com/de/produkte/0828282>



Marker carriers, gray, unlabeled, mounting type: snapped, lettering field size: 10.5 x 300 mm

# Test disconnect terminal block - UTME 4

3047452

<https://www.phoenixcontact.com/de/produkte/3047452>

## DIN rail, unperforated

DIN rail, unperforated - NS 35/ 7,5 WH UNPERF 2000MM-VPE 10 - 1204122

<https://www.phoenixcontact.com/de/produkte/1204122>



DIN rail, unperforated, acc. to EN 60715, material: Steel, Galvanized, white passivated, Standard profile, color: silver, Pack of 10 (20 m)

---

## Switching lock

Switching lock - S-ME 4 - 3035758

<https://www.phoenixcontact.com/de/produkte/3035758>



Switching lock, length: 12 mm, width: 6.2 mm, color: white

# Test disconnect terminal block - UTME 4

3047452

<https://www.phoenixcontact.com/de/produkte/3047452>

## DIN rail, unperforated

DIN rail, unperforated - NS 35/ 7,5 AL UNPERF 2000MM - 0801704

<https://www.phoenixcontact.com/de/produkte/0801704>



DIN rail, unperforated, acc. to EN 60715, material: Aluminum, uncoated, Standard profile, color: silver, Pack of 25 (50 m)

---

## Cover profile

Cover profile - AP-ME                      METER - 3034361

<https://www.phoenixcontact.com/de/produkte/3034361>



Cover profile, for covering terminal strips, snapped onto APT-ME cover profile carrier or APH-ME end bracket. A cover profile carrier should be positioned at the ends and at intervals of around 40 cm. Length supplied: 1 m

# Test disconnect terminal block - UTME 4

3047452

<https://www.phoenixcontact.com/de/produkte/3047452>

## DIN rail perforated

DIN rail perforated - NS 35/ 7,5 ZN PERF 2000MM - 1206421

<https://www.phoenixcontact.com/de/produkte/1206421>



DIN rail perforated, acc. to EN 60715, material: Steel, galvanized, Standard profile, color: silver, Pack of 25 (50 m)

---

## Cover profile carrier

Cover profile carrier - APH-ME - 3034374

<https://www.phoenixcontact.com/de/produkte/3034374>

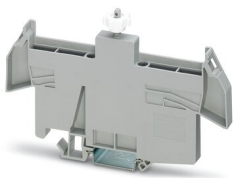

Cover profile carrier, for mounting on NS 35/7,5 DIN rail, for fixing the AP-ME cover profile, can be sealed as an option

# Test disconnect terminal block - UTME 4

3047452

<https://www.phoenixcontact.com/de/produkte/3047452>

## DIN rail, unperforated

DIN rail, unperforated - NS 35/ 7,5 ZN UNPERF 2000MM - 1206434

<https://www.phoenixcontact.com/de/produkte/1206434>



DIN rail, unperforated, acc. to EN 60715, material: Steel, galvanized, Standard profile, color: silver, Pack of 25 (50 m)

---

## Cover profile carrier

Cover profile carrier - APT-ME - 3034358

<https://www.phoenixcontact.com/de/produkte/3034358>



Cover profile carrier for mounting on NS 35/7.5 DIN rail for attaching the cover profile AP-ME

# Test disconnect terminal block - UTME 4

3047452

<https://www.phoenixcontact.com/de/produkte/3047452>

## DIN rail, unperforated

DIN rail, unperforated - NS 35/ 7,5 CU UNPERF 2000MM-VPE 10 - 0801762

<https://www.phoenixcontact.com/de/produkte/0801762>



DIN rail, unperforated, acc. to EN 60715, material: Copper, uncoated, Standard profile, color: copper-colored, Pack of 10 (20 m)

---

## End cover

End cover - D-UTME 4 - 3047491

<https://www.phoenixcontact.com/de/produkte/3047491>

Cover, width: 2.2 mm



# Test disconnect terminal block - UTME 4

3047452

<https://www.phoenixcontact.com/de/produkte/3047452>

## End cap

End cap - NS 35/ 7,5 CAP - 1206560

<https://www.phoenixcontact.com/de/produkte/1206560>

DIN rail end piece, for DIN rail NS 35/7.5



---

## Connecting bridge

Connecting bridge - C-ME 4/2 - 3035759

<https://www.phoenixcontact.com/de/produkte/3035759>

Connection bridge, for connecting 2 test disconnect terminal blocks





# Test disconnect terminal block - UTME 4

3047452

<https://www.phoenixcontact.com/de/produkte/3047452>

## DIN rail perforated

DIN rail perforated - NS 35/15 PERF 2000MM - 1201730

<https://www.phoenixcontact.com/de/produkte/1201730>



DIN rail perforated, similar to EN 60715, material: Steel, galvanized, passivated with a thick layer, Standard profile, color: silver, Pack of 25 (50 m)

---

## Operating lever

Operating lever - C-ME 4/3 - 3035760

<https://www.phoenixcontact.com/de/produkte/3035760>



Operating lever, for connecting three test disconnect terminal blocks

# Test disconnect terminal block - UTME 4

3047452

<https://www.phoenixcontact.com/de/produkte/3047452>

## DIN rail, unperforated

DIN rail, unperforated - NS 35/15 UNPERF 2000MM - 1201714

<https://www.phoenixcontact.com/de/produkte/1201714>



DIN rail, unperforated, similar to EN 60715, material: Steel, galvanized, passivated with a thick layer, Standard profile, color: silver, Pack of 25 (50 m)

---

## Separating plate

Separating plate - TS-UK 6-T - 3072820

<https://www.phoenixcontact.com/de/produkte/3072820>

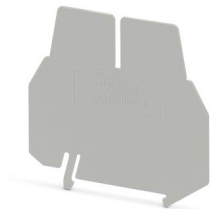

Separating plate, length: 66.5 mm, width: 1 mm, height: 62.5 mm, color: gray

# Test disconnect terminal block - UTME 4

3047452

<https://www.phoenixcontact.com/de/produkte/3047452>

## DIN rail perforated

DIN rail perforated - NS 35/15 WH PERF 2000MM - 0806602

<https://www.phoenixcontact.com/de/produkte/0806602>



DIN rail perforated, similar to EN 60715, material: Steel, Galvanized, white passivated, Standard profile, color: white, Pack of 25 (50 m)

---

## Operating lever

Operating lever - C-ME 4/1 - 1062645

<https://www.phoenixcontact.com/de/produkte/1062645>



Operating lever, for switching test disconnect terminal blocks on and off

# Test disconnect terminal block - UTME 4

3047452

<https://www.phoenixcontact.com/de/produkte/3047452>

## DIN rail, unperforated

DIN rail, unperforated - NS 35/15 WH UNPERF 2000MM-VPE 10 - 1204135

<https://www.phoenixcontact.com/de/produkte/1204135>



DIN rail, unperforated, similar to EN 60715, material: Steel, Galvanized, white passivated, Standard profile, color: silver, Pack of 10 (20 m)

---

## Screwdriver

Screwdriver - SF-SL 0,6X3,5-100 S-VDE - 1212587

<https://www.phoenixcontact.com/de/produkte/1212587>



Actuation tool, for ST terminal blocks, VDE insulated, with slimmer insulation integrated in the blade, also suitable for use as a bladed screwdriver, size: 0.6 x 3.5 x 100 mm, 2-component grip, with non-slip grip

# Test disconnect terminal block - UTME 4

3047452

<https://www.phoenixcontact.com/de/produkte/3047452>

## DIN rail, unperforated

DIN rail, unperforated - NS 35/15 AL UNPERF 2000MM - 1201756

<https://www.phoenixcontact.com/de/produkte/1201756>



DIN rail, unperforated, similar to EN 60715, material: Aluminum, uncoated, Standard profile, color: silver

---

## DIN rail perforated

DIN rail perforated - NS 35/15 ZN PERF 2000MM - 1206599

<https://www.phoenixcontact.com/de/produkte/1206599>



DIN rail perforated, similar to EN 60715, material: Steel, galvanized, Standard profile, color: silver, Pack of 25 (50 m)

# Test disconnect terminal block - UTME 4

3047452

<https://www.phoenixcontact.com/de/produkte/3047452>

## DIN rail, unperforated

DIN rail, unperforated - NS 35/15 ZN UNPERF 2000MM - 1206586

<https://www.phoenixcontact.com/de/produkte/1206586>



DIN rail, unperforated, similar to EN 60715, material: Steel, galvanized, Standard profile, color: silver, Pack of 25 (50 m)

---

## DIN rail, unperforated

DIN rail, unperforated - NS 35/15 CU UNPERF 2000MM-VPE 10 - 1201895

<https://www.phoenixcontact.com/de/produkte/1201895>



DIN rail, unperforated, similar to EN 60715, material: Copper, uncoated, Standard profile, color: copper-colored, Pack of 10 (20 m)

# Test disconnect terminal block - UTME 4

3047452

<https://www.phoenixcontact.com/de/produkte/3047452>

## End cap

End cap - NS 35/15 CAP - 1206573

<https://www.phoenixcontact.com/de/produkte/1206573>

DIN rail end piece, for DIN rail NS 35/15



---

## DIN rail, unperforated

DIN rail, unperforated - NS 35/15-2,3 UNPERF 2000MM-VPE 10 - 1201798

<https://www.phoenixcontact.com/de/produkte/1201798>



DIN rail, unperforated, acc. to EN 60715, material: Steel, galvanized, passivated with a thick layer, Standard profile 2.3 mm, color: silver, Pack of 10 (20 m)

# Test disconnect terminal block - UTME 4

3047452

<https://www.phoenixcontact.com/de/produkte/3047452>

## Zack marker strip

Zack marker strip - ZB 6:UNBEDRUCKT - 1051003

<https://www.phoenixcontact.com/de/produkte/1051003>



Zack marker strip, Strip, white, unlabeled, can be labeled with: PLOTMARK, CMS-P1-PLOTTER, mounting type: snapped, for terminal block width: 6.2 mm, lettering field size: 6.15 x 10.5 mm, Number of individual labels: 10

---

## Zack marker strip

Zack marker strip - ZB 6 CUS - 0824992

<https://www.phoenixcontact.com/de/produkte/0824992>



Zack marker strip, can be ordered: Strip, white, labeled according to customer specifications, mounting type: snap into tall marker groove, for terminal block width: 6.2 mm, lettering field size: 6.15 x 10.5 mm, Number of individual labels: 10



# Test disconnect terminal block - UTME 4

3047452

<https://www.phoenixcontact.com/de/produkte/3047452>

## Zack marker strip

Zack marker strip - ZB 6,LGS:FORTL.ZAHLEN - 1051016

<https://www.phoenixcontact.com/de/produkte/1051016>



Zack marker strip, Strip, white, labeled, can be labeled with: CMS-P1-PLOTTER, printed horizontally: consecutive numbers 1 ... 10, 11 ... 20, etc. up to 491 ... 500, mounting type: snapped, for terminal block width: 6.2 mm, lettering field size: 6. 15 x 10.5 mm, Number of individual labels: 10

---

## Zack marker strip

Zack marker strip - ZB 6,QR:FORTL.ZAHLEN - 1051029

<https://www.phoenixcontact.com/de/produkte/1051029>

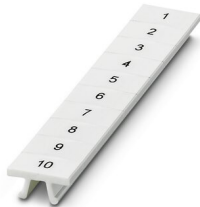

Zack marker strip, Strip, white, labeled, can be labeled with: CMS-P1-PLOTTER, Printed vertically: consecutive numbers 1 ... 10, 11 ... 20, etc. up to 491 ... 500, mounting type: snapped, for terminal block width: 6.2 mm, lettering field size: 6. 15 x 10.5 mm, Number of individual labels: 10

# Test disconnect terminal block - UTME 4

3047452

<https://www.phoenixcontact.com/de/produkte/3047452>

## Zack marker strip

Zack marker strip - ZB 6,LGS:GLEICHE ZAHLEN - 1051032

<https://www.phoenixcontact.com/de/produkte/1051032>



Zack marker strip, Strip, white, labeled, can be labeled with: CMS-P1-PLOTTER, printed horizontally: Identical numbers 1 or 2, etc. up to 100, mounting type: snapped, for terminal block width: 6.2 mm, lettering field size: 6.15 x 10.5 mm, Number of individual labels: 10

---

## Marker for terminal blocks

Marker for terminal blocks - ZB 6,LGS:L1-N,PE - 1051414

<https://www.phoenixcontact.com/de/produkte/1051414>



Marker for terminal blocks, Strip, white, labeled, can be labeled with: CMS-P1-PLOTTER, horizontal: L1, L2, L3, N, PE, L1, L2, L3, N, PE, mounting type: snapped, for terminal block width: 6.2 mm, lettering field size: 6.15 x 10.5 mm, Number of individual labels: 10

# Test disconnect terminal block - UTME 4

3047452

<https://www.phoenixcontact.com/de/produkte/3047452>

## Marker for terminal blocks

Marker for terminal blocks - ZB 6,LGS:U-N - 1051430

<https://www.phoenixcontact.com/de/produkte/1051430>



Marker for terminal blocks, Strip, white, labeled, can be labeled with: CMS-P1-PLOTTER, printed horizontally: U, V, W, N, GND, U, V, W, N, GND, mounting type: snapped, for terminal block width: 6.2 mm, lettering field size: 6.15 x 10.5 mm, Number of individual labels: 10

---

## Marker for terminal blocks

Marker for terminal blocks - UC-TM 6 - 0818085

<https://www.phoenixcontact.com/de/produkte/0818085>



Marker for terminal blocks, Sheet, white, unlabeled, can be labeled with: BLUEMARK ID COLOR, BLUEMARK ID, BLUEMARK CLED, PLOTMARK, CMS-P1-PLOTTER, mounting type: snapped, for terminal block width: 6.2 mm, lettering field size: 5.6 x 10.5 mm, Number of individual labels: 80

# Test disconnect terminal block - UTME 4

3047452

<https://www.phoenixcontact.com/de/produkte/3047452>

## Marker for terminal blocks

Marker for terminal blocks - UC-TM 6 CUS - 0824589

<https://www.phoenixcontact.com/de/produkte/0824589>



Marker for terminal blocks, can be ordered: by sheet, white, labeled according to customer specifications, mounting type: snap into tall marker groove, for terminal block width: 6.2 mm, lettering field size: 5.6 x 10.5 mm, Number of individual labels: 80

---

## Marker for terminal blocks

Marker for terminal blocks - UCT-TM 6 - 0828736

<https://www.phoenixcontact.com/de/produkte/0828736>



Marker for terminal blocks, Sheet, white, unlabeled, can be labeled with: TOPMARK NEO, TOPMARK LASER, BLUEMARK ID COLOR, BLUEMARK ID, BLUEMARK CLED, THERMOMARK PRIME, THERMOMARK CARD 2.0, THERMOMARK CARD, mounting type: snapped, for terminal block width: 6.2 mm, lettering field size: 5.6 x 10.5 mm, Number of individual labels: 60

# Test disconnect terminal block - UTME 4

3047452

<https://www.phoenixcontact.com/de/produkte/3047452>

## Marker for terminal blocks

Marker for terminal blocks - UCT-TM 6 CUS - 0829602

<https://www.phoenixcontact.com/de/produkte/0829602>



Marker for terminal blocks, can be ordered: by sheet, white, labeled according to customer specifications, mounting type: snap into tall marker groove, for terminal block width: 6.2 mm, lettering field size: 5.6 x 10.5 mm, Number of individual labels: 60

---

## Zack Marker strip, flat

Zack Marker strip, flat - ZBF 6:UNBEDRUCKT - 0808710

<https://www.phoenixcontact.com/de/produkte/0808710>



Zack Marker strip, flat, Strip, white, unlabeled, can be labeled with: PLOTMARK, CMS-P1-PLOTTER, mounting type: snapped, for terminal block width: 6.2 mm, lettering field size: 5.15 x 6.15 mm, Number of individual labels: 10

# Test disconnect terminal block - UTME 4

3047452

<https://www.phoenixcontact.com/de/produkte/3047452>

## Zack Marker strip, flat

Zack Marker strip, flat - ZBF 6 CUS - 0825027

<https://www.phoenixcontact.com/de/produkte/0825027>



Zack Marker strip, flat, Strip, can be ordered: Strip, white, labeled according to customer specifications, mounting type: snap into flat marker groove, for terminal block width: 6.2 mm, lettering field size: 5.15 x 6.15 mm, Number of individual labels: 10

---

## Marker for terminal blocks

Marker for terminal blocks - UC-TMF 6 - 0818140

<https://www.phoenixcontact.com/de/produkte/0818140>



Marker for terminal blocks, Sheet, white, unlabeled, can be labeled with: BLUEMARK ID COLOR, BLUEMARK ID, BLUEMARK CLED, PLOTMARK, CMS-P1-PLOTTER, mounting type: snapped, for terminal block width: 6.2 mm, lettering field size: 5.6 x 5.1 mm, Number of individual labels: 80

# Test disconnect terminal block - UTME 4

3047452

<https://www.phoenixcontact.com/de/produkte/3047452>

## Marker for terminal blocks

Marker for terminal blocks - UC-TMF 6 CUS - 0824646

<https://www.phoenixcontact.com/de/produkte/0824646>



Marker for terminal blocks, can be ordered: by sheet, white, labeled according to customer specifications, mounting type: snap into flat marker groove, for terminal block width: 6.2 mm, lettering field size: 5.6 x 5.1 mm, Number of individual labels: 80

---

## Marker for terminal blocks

Marker for terminal blocks - UCT-TMF 6 - 0828746

<https://www.phoenixcontact.com/de/produkte/0828746>



Marker for terminal blocks, Sheet, white, unlabeled, can be labeled with: TOPMARK NEO, TOPMARK LASER, BLUEMARK ID COLOR, BLUEMARK ID, BLUEMARK CLED, THERMOMARK PRIME, THERMOMARK CARD 2.0, THERMOMARK CARD, mounting type: snapped, for terminal block width: 6.2 mm, lettering field size: 5.4 x 4.7 mm, Number of individual labels: 60

# Test disconnect terminal block - UTME 4

3047452

<https://www.phoenixcontact.com/de/produkte/3047452>

## Marker for terminal blocks

Marker for terminal blocks - UCT-TMF 6 CUS - 0829665

<https://www.phoenixcontact.com/de/produkte/0829665>



Marker for terminal blocks, can be ordered: by sheet, white, labeled according to customer specifications, mounting type: snap into flat marker groove, for terminal block width: 6.2 mm, lettering field size: 5.4 x 4.7 mm, Number of individual labels: 60

---

## Zack Marker strip, flat

Zack Marker strip, flat - ZBF 6,LGS:FORTL.ZAHLEN - 0808749

<https://www.phoenixcontact.com/de/produkte/0808749>



Zack Marker strip, flat, Strip, white, labeled, printed horizontally: consecutive numbers 1 ... 10, 11 ... 20, etc. up to 91 ... 100, mounting type: snapped, for terminal block width: 6.2 mm, lettering field size: 5.15 x 6.15 mm, Number of individual labels: 10



# Test disconnect terminal block - UTME 4

3047452

<https://www.phoenixcontact.com/de/produkte/3047452>

## Zack Marker strip, flat

Zack Marker strip, flat - ZBF 6,QR:FORTL.ZAHLEN - 0808765

<https://www.phoenixcontact.com/de/produkte/0808765>



Zack Marker strip, flat, Strip, white, labeled, Printed vertically: consecutive numbers 1 ... 10, 11 ... 20, etc. up to 91 ... 100, mounting type: snapped, for terminal block width: 6.2 mm, lettering field size: 5.15 x 6.15 mm, Number of individual labels: 10

---

## Zack Marker strip, flat

Zack Marker strip, flat - ZBF 6,LGS:GERADE ZAHLEN - 0810834

<https://www.phoenixcontact.com/de/produkte/0810834>



Zack Marker strip, flat, Strip, white, labeled, printed horizontally: consecutive even numbers 2 ... 20, 22 ... 40, etc. up to 82 ... 100, mounting type: snapped, for terminal block width: 6.2 mm, lettering field size: 5.15 x 6.15 mm, Number of individual labels: 10

# Test disconnect terminal block - UTME 4

3047452

<https://www.phoenixcontact.com/de/produkte/3047452>

## Zack Marker strip, flat

Zack Marker strip, flat - ZBF 6,LGS:UNGERADE ZAHLEN - 0810876

<https://www.phoenixcontact.com/de/produkte/0810876>

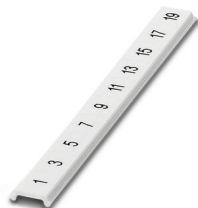

Zack Marker strip, flat, Strip, white, labeled, printed horizontally: Odd numbers 1 - 19, 21 - 39, etc. up to 81 - 99, mounting type: snapped, for terminal block width: 6.2 mm, lettering field size: 5.15 x 6.15 mm, Number of individual labels: 10

---

## Test plugs

Test plugs - MPS-MT - 0201744

<https://www.phoenixcontact.com/de/produkte/0201744>



Test plugs, with solder connection up to 1 mm<sup>2</sup> conductor cross section, color: gray

# Test disconnect terminal block - UTME 4

3047452

<https://www.phoenixcontact.com/de/produkte/3047452>

## Insulating sleeve

Insulating sleeve - MPS-IH WH - 0201663

<https://www.phoenixcontact.com/de/produkte/0201663>

Insulating sleeve, color: white



---

## Insulating sleeve

Insulating sleeve - MPS-IH RD - 0201676

<https://www.phoenixcontact.com/de/produkte/0201676>

Insulating sleeve, color: red



# Test disconnect terminal block - UTME 4

3047452

<https://www.phoenixcontact.com/de/produkte/3047452>

## Insulating sleeve

Insulating sleeve - MPS-IH BU - 0201689

<https://www.phoenixcontact.com/de/produkte/0201689>

Insulating sleeve, color: blue

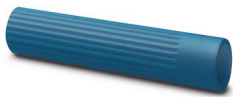

---

## Insulating sleeve

Insulating sleeve - MPS-IH YE - 0201692

<https://www.phoenixcontact.com/de/produkte/0201692>

Insulating sleeve, color: yellow



# Test disconnect terminal block - UTME 4

3047452

<https://www.phoenixcontact.com/de/produkte/3047452>

## Insulating sleeve

Insulating sleeve - MPS-IH GN - 0201702

<https://www.phoenixcontact.com/de/produkte/0201702>

Insulating sleeve, color: green



## Insulating sleeve

Insulating sleeve - MPS-IH GY - 0201728

<https://www.phoenixcontact.com/de/produkte/0201728>

Insulating sleeve, color: gray



# Test disconnect terminal block - UTME 4

3047452

<https://www.phoenixcontact.com/de/produkte/3047452>

## Insulating sleeve

Insulating sleeve - MPS-IH BK - 0201731

<https://www.phoenixcontact.com/de/produkte/0201731>

Insulating sleeve, color: black



## Insulating sleeve

Insulating sleeve - ISH 4/0,5 - 3002885

<https://www.phoenixcontact.com/de/produkte/3002885>

Insulating sleeve, color: gray



# Test disconnect terminal block - UTME 4

3047452

<https://www.phoenixcontact.com/de/produkte/3047452>

## Insulating sleeve

Insulating sleeve - ISH 4/1,0 - 3002898

<https://www.phoenixcontact.com/de/produkte/3002898>



Insulating sleeve, color: black

---

## Test adapter

Test adapter - PAI-4-FIX-5/6 BU - 3035975

<https://www.phoenixcontact.com/de/produkte/3035975>



4 mm test adapter, for terminal blocks with 5.2 mm and 6.2 mm pitch

# Test disconnect terminal block - UTME 4

3047452

<https://www.phoenixcontact.com/de/produkte/3047452>

## Test adapter

Test adapter - PAI-4-FIX-5/6 OG - 3035974

<https://www.phoenixcontact.com/de/produkte/3035974>

4 mm test adapter, for terminal blocks with 5.2 mm and 6.2 mm pitch



---

## Test adapter

Test adapter - PAI-4-FIX-5/6 YE - 3035977

<https://www.phoenixcontact.com/de/produkte/3035977>

4 mm test adapter, for terminal blocks with 5.2 mm and 6.2 mm pitch





# Test disconnect terminal block - UTME 4

3047452

<https://www.phoenixcontact.com/de/produkte/3047452>

## Test adapter

Test adapter - PAI-4-FIX-5/6 RD - 3035976

<https://www.phoenixcontact.com/de/produkte/3035976>



4 mm test adapter, for terminal blocks with 5.2 mm and 6.2 mm pitch

---

## Test adapter

Test adapter - PAI-4-FIX-5/6 GN - 3035978

<https://www.phoenixcontact.com/de/produkte/3035978>



4 mm test adapter, for terminal blocks with 5.2 mm and 6.2 mm pitch

# Test disconnect terminal block - UTME 4

3047452

<https://www.phoenixcontact.com/de/produkte/3047452>

## Test adapter

Test adapter - PAI-4-FIX-5/6 BK - 3035980

<https://www.phoenixcontact.com/de/produkte/3035980>



4 mm test adapter, for terminal blocks with 5.2 mm and 6.2 mm pitch

---

## Test adapter

Test adapter - PAI-4-FIX-5/6 GY - 3035982

<https://www.phoenixcontact.com/de/produkte/3035982>



4 mm test adapter, for terminal blocks with 5.2 mm and 6.2 mm pitch

# Test disconnect terminal block - UTME 4

3047452

<https://www.phoenixcontact.com/de/produkte/3047452>

## Test adapter

Test adapter - PAI-4-FIX-5/6 VT - 3035979

<https://www.phoenixcontact.com/de/produkte/3035979>

4 mm test adapter, for terminal blocks with 5.2 mm and 6.2 mm pitch



---

## Test adapter

Test adapter - PAI-4-FIX-5/6 BN - 3035981

<https://www.phoenixcontact.com/de/produkte/3035981>

4 mm test adapter, for terminal blocks with 5.2 mm and 6.2 mm pitch



# Test disconnect terminal block - UTME 4

3047452

<https://www.phoenixcontact.com/de/produkte/3047452>

## Test adapter

Test adapter - PAI-4-FIX-5/6 WH - 3035983

<https://www.phoenixcontact.com/de/produkte/3035983>

4 mm test adapter, for terminal blocks with 5.2 mm and 6.2 mm pitch



---

## Test plugs

Test plugs - PS-6 - 3030996

<https://www.phoenixcontact.com/de/produkte/3030996>

Test plugs, Modular test plug, color: red



# Test disconnect terminal block - UTME 4

3047452

<https://www.phoenixcontact.com/de/produkte/3047452>

## Test plugs

Test plugs - PS-6/2,3MM RD - 3038736

<https://www.phoenixcontact.com/de/produkte/3038736>



Test plugs, color: red

---

## Marker for terminal blocks

Marker for terminal blocks - TMT 6 R - 0816498

<https://www.phoenixcontact.com/de/produkte/0816498>



Marker for terminal blocks, Roll, white, unlabeled, can be labeled with: THERMOMARK ROLL 2.0, THERMOMARK ROLL, THERMOMARK ROLL X1, THERMOMARK ROLLMASTER 300/600, THERMOMARK X1.2, THERMOMARK S1.1, perforated, mounting type: snapped, snap into flat marker groove, for terminal block width: 6.2 mm, lettering field size: 6.35 x 6.15 mm, Number of individual labels: 16000

# Test disconnect terminal block - UTME 4

3047452

<https://www.phoenixcontact.com/de/produkte/3047452>

## Marker for terminal blocks

Marker for terminal blocks - TMT 6 R CUS - 0824488

<https://www.phoenixcontact.com/de/produkte/0824488>



Marker for terminal blocks, can be ordered: by line, white, labeled according to customer specifications, mounting type: snap into universal marker groove, snap into flat marker groove, for terminal block width: 6.2 mm, lettering field size: 6.35 x 6.15 mm

---

## Marker for terminal blocks

Marker for terminal blocks - TMT (EX9,5)R - 0828295

<https://www.phoenixcontact.com/de/produkte/0828295>



Marker for terminal blocks, Roll, white, unlabeled, can be labeled with: THERMOMARK ROLL 2.0, THERMOMARK ROLL, THERMOMARK ROLL X1, THERMOMARK ROLLMASTER 300/600, THERMOMARK X1.2, mounting type: snapped, snap into tall marker groove, for terminal block width: 50000 mm, lettering field size: 9.5 x 50000 mm, Number of individual labels: 1

# Test disconnect terminal block - UTME 4

3047452

<https://www.phoenixcontact.com/de/produkte/3047452>

## Marker for terminal blocks

Marker for terminal blocks - US-TM 100 - 0829255

<https://www.phoenixcontact.com/de/produkte/0829255>

Marker for terminal blocks, Card, white, unlabeled, can be labeled with: BLUEMARK ID COLOR, BLUEMARK ID, THERMOMARK PRIME, THERMOMARK CARD 2.0, THERMOMARK CARD, mounting type: snapped, lettering field size: 104 x 9.8 mm, Number of individual labels: 13



---

## End clamp

End clamp - CLIPFIX 35 - 3022218

<https://www.phoenixcontact.com/de/produkte/3022218>

Quick mounting end clamp for NS 35/7,5 DIN rail or NS 35/15 DIN rail, with marking option, width: 9.5 mm, color: gray



# Test disconnect terminal block - UTME 4

3047452

<https://www.phoenixcontact.com/de/produkte/3047452>

## End clamp

End clamp - CLIPFIX 35-5 - 3022276

<https://www.phoenixcontact.com/de/produkte/3022276>



Quick mounting end clamp for NS 35/7,5 DIN rail or NS 35/15 DIN rail, with marking option, with parking option for FBS...5, FBS...6, KSS 5, KSS 6, width: 5.15 mm, color: gray

---

## End clamp

End clamp - E/NS 35 N - 0800886

<https://www.phoenixcontact.com/de/produkte/0800886>

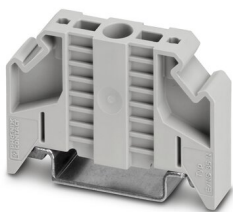

End clamp, width: 9.5 mm, color: gray

---

Phoenix Contact 2022 © - all rights reserved  
<https://www.phoenixcontact.com>

PHOENIX CONTACT Deutschland GmbH  
Flachsmarktstraße 8  
D-32825 Blomberg  
+49 52 35/3-1 20 00  
[info@phoenixcontact.de](mailto:info@phoenixcontact.de)