

High-current terminal block - PTPOWER 35

3212064

<https://www.phoenixcontact.com/de/produkte/3212064>

Please be informed that the data shown in this PDF document is generated from our Online Catalog. Please find the complete data in the user documentation. Our General Terms of Use for Downloads are valid.



High-current terminal block, nom. voltage: 1000 V, nominal current: 125 A, connection method: Power-Turn connection, 1 level, cross section: 2.5 mm² - 35 mm², mounting type: NS 35/15, color: gray

Your advantages

- Quick and easy connection is now also possible for large conductors with the high-current terminal block
- The Push-in connection terminal blocks are characterized by the system features of the CLIPLINE complete system and by easy and tool-free wiring of conductors with ferrules or solid conductors
- In addition to the testing facility in the double function shaft, all terminal blocks provide an additional test connection
- The compact design and front connection enable wiring in a confined space

High-current terminal block - PTPOWER 35



3212064

<https://www.phoenixcontact.com/de/produkte/3212064>

Commercial Data

Item number	3212064
Packing unit	10 pc
Minimum order quantity	1 pc
Sales Key	A1 - Reihenklennen
Product Key	BE2211
Catalog Page	Page 135 (C-1-2019)
GTIN	4046356726016
Weight per Piece (including packing)	89,77 g
Weight per Piece (excluding packing)	83,76 g
Customs tariff number	85369010
Country of origin	PL

High-current terminal block - PTPOWER 35



3212064

<https://www.phoenixcontact.com/de/produkte/3212064>

Technical Data

Product properties

Product type	High current terminal block
Number of connections	2
Number of rows	1
Potentials	1

Insulation characteristics

Overvoltage category	III
Degree of pollution	3

Electrical properties

Rated surge voltage	8 kV
Maximum power dissipation for nominal condition	4.06 W

Connection data

Number of connections per level	2
Nominal cross section	35 mm ²
Rated cross section AWG	2

1 level

Stripping length	25 mm
Conductor cross section solid	2.5 mm ² ... 35 mm ²
Cross section AWG	12 ... 2
Conductor cross section flexible	2.5 mm ² ... 35 mm ²
Conductor cross section, flexible [AWG]	12 ... 2
Flexible conductor cross section flexible (ferrule, w/o plastic sleeve)	2.5 mm ² ... 35 mm ²
Flexible conductor cross section (ferrule with plastic sleeve)	2.5 mm ² ... 35 mm ²
Nominal current	125 A
Maximum load current	125 A (with 35 mm ² conductor cross section)
Nominal voltage	1000 V

1 level Connection cross sections directly pluggable

Conductor cross section solid	2.5 mm ² ... 35 mm ²
Conductor cross section, solid [AWG]	12 ... 2
Flexible conductor cross section flexible (ferrule, w/o plastic sleeve)	2.5 mm ² ... 35 mm ²
Flexible conductor cross section (ferrule with plastic sleeve)	2.5 mm ² ... 35 mm ²

Dimensions

Width	16 mm
Height NS 35/15	77.3 mm
Height NS 35/7,5	69.8 mm

High-current terminal block - PTPOWER 35



3212064

<https://www.phoenixcontact.com/de/produkte/3212064>

Length	91.6 mm
--------	---------

Material specifications

Color	gray
Flammability rating according to UL 94	V0
Insulating material group	I
Insulating material	PA
Static insulating material application in cold	-60 °C
Temperature index of insulation material (DIN EN 60216-1 (VDE 0304-21))	125 °C
Relative insulation material temperature index (Elec., UL 746 B)	130 °C
Fire protection for rail vehicles (DIN EN 45545-2) R22	HL 1 - HL 3
Fire protection for rail vehicles (DIN EN 45545-2) R23	HL 1 - HL 3
Fire protection for rail vehicles (DIN EN 45545-2) R24	HL 1 - HL 3
Fire protection for rail vehicles (DIN EN 45545-2) R26	HL 1 - HL 3
Calorimetric heat release NFPA 130 (ASTM E 1354)	27,5 MJ/kg
Surface flammability NFPA 130 (ASTM E 162)	passed
Specific optical density of smoke NFPA 130 (ASTM E 662)	passed
Smoke gas toxicity NFPA 130 (SMP 800C)	passed

Electrical tests

Surge voltage test

Test voltage setpoint	9.8 kV
Result	Test passed

Temperature-rise test

Requirement temperature-rise test	Increase in temperature \leq 45 K
Result	Test passed
Short-time withstand current 35 mm ²	4.2 kA
Result	Test passed

Power-frequency withstand voltage

Test voltage setpoint	2.2 kV
Result	Test passed

Mechanical properties

Mechanical data

Open side panel	No
-----------------	----

Mechanical tests

Mechanical strength

Result	Test passed
--------	-------------

Attachment on the carrier

DIN rail/fixing support	NS 35
-------------------------	-------

High-current terminal block - PTPOWER 35



3212064

<https://www.phoenixcontact.com/de/produkte/3212064>

Test force setpoint	10 N
Result	Test passed

Test for conductor damage and slackening

Rotation speed	10 rpm
Revolutions	135
Conductor cross section/weight	2.5 mm ² / 0.7 kg 35 mm ² / 6.8 kg
Result	Test passed

Environmental and real-life conditions

Aging

Temperature cycles	192
Result	Test passed

Needle-flame test

Time of exposure	30 s
Result	Test passed

Oscillation/broadband noise

Specification	DIN EN 50155 (VDE 0115-200):2008-03
Spectrum	Service life test category 2, bogie-mounted
Frequency	$f_1 = 5 \text{ Hz}$ to $f_2 = 250 \text{ Hz}$
ASD level	6.12 (m/s ²) ² /Hz
Acceleration	3.12g
Test duration per axis	5 h
Test directions	X-, Y- and Z-axis
Result	Test passed

Shocks

Specification	DIN EN 50155 (VDE 0115-200):2008-03
Pulse shape	Half-sine
Acceleration	30g
Shock duration	18 ms
Number of shocks per direction	3
Test directions	X-, Y- and Z-axis (pos. and neg.)
Result	Test passed

Ambient conditions

Ambient temperature (operation)	-60 °C ... 105 °C (max. short-term operating temperature RTI Elec.)
Ambient temperature (storage/transport)	-25 °C ... 60 °C (for a short time, not exceeding 24 h, -60 °C to +70 °C)
Ambient temperature (assembly)	-5 °C ... 70 °C
Ambient temperature (actuation)	-5 °C ... 70 °C
Permissible humidity (storage/transport)	30 % ... 70 %

High-current terminal block - PTPOWER 35



3212064

<https://www.phoenixcontact.com/de/produkte/3212064>

Mounting

Mounting type	NS 35/15
---------------	----------

High-current terminal block - PTPOWER 35

3212064

<https://www.phoenixcontact.com/de/produkte/3212064>

Drawings

Schematic diagram

PTPOWER

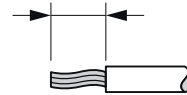

AGK 10-PTPOWER	0,5 mm ² ... 16 mm ²	18 mm
PTPOWER 35	2,5 mm ² ... 35 mm ²	25 mm
PTPOWER 50	10 mm ² ... 50 mm ²	32 mm
PTPOWER 95	25 mm ² ... 95 mm ²	40 mm
PTPOWER 185	95 mm ² ... 185 mm ²	40 mm

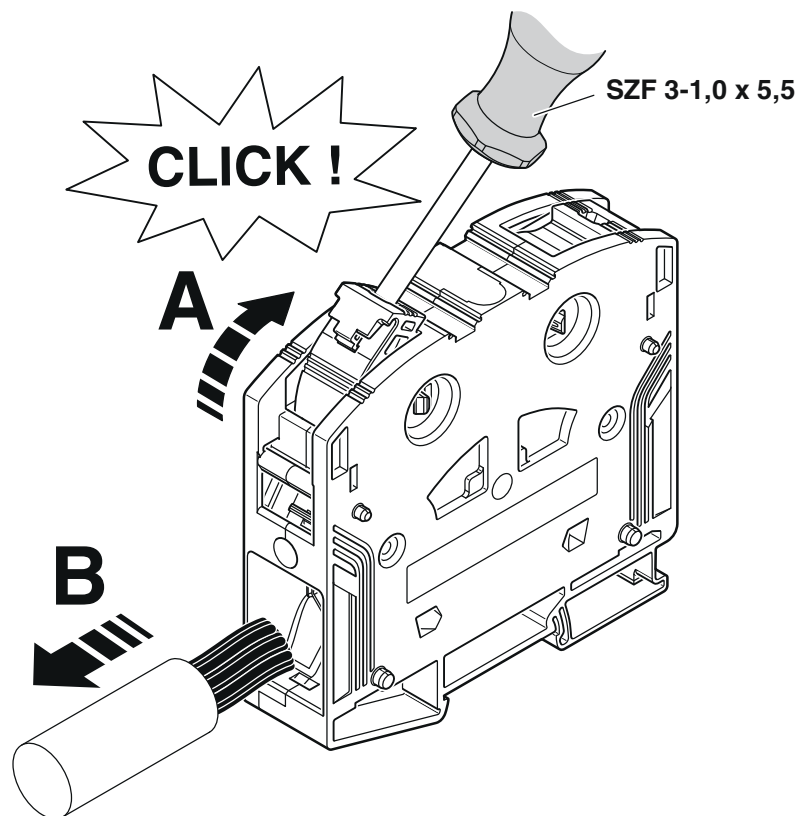

High-current terminal block - PTPOWER 35



3212064

<https://www.phoenixcontact.com/de/produkte/3212064>

Circuit diagram



High-current terminal block - PTPOWER 35





3212064

<https://www.phoenixcontact.com/de/produkte/3212064>

Approvals

 CSA Approval ID: 13631				
	Nominal Voltage U_N	Nominal Current I_N	Cross Section AWG	Cross Section mm^2
Use group B		115 A	14 - 2	-
Use group C		115 A	14 - 2	-

 cUL Recognized Approval ID: E60425				
	Nominal Voltage U_N	Nominal Current I_N	Cross Section AWG	Cross Section mm^2
Use group C		115 A	14 - 2	-

 UL Recognized Approval ID: E60425				
	Nominal Voltage U_N	Nominal Current I_N	Cross Section AWG	Cross Section mm^2
Use group E		115 A	14 - 2	-

 EAC Approval ID: RU C-DE.AI30.B.01102				
---	--	--	--	--

DNV Approval ID: TAE00000Z9				
---------------------------------------	--	--	--	--

 CCC Approval ID: 2020322313000630				
---	--	--	--	--

cULus Recognized				
-------------------------	--	--	--	--

High-current terminal block - PTPOWER 35



3212064

<https://www.phoenixcontact.com/de/produkte/3212064>

Classifications

ECLASS

ECLASS-9.0	27141120
ECLASS-10.0.1	27141120
ECLASS-11.0	27141120

ETIM

ETIM 8.0	EC000897
----------	----------

UNSPSC

UNSPSC 21.0	39121400
-------------	----------

High-current terminal block - PTPOWER 35



3212064

<https://www.phoenixcontact.com/de/produkte/3212064>

Environmental Product Compliance

China RoHS	Environmentally friendly use period: unlimited = EFUP-e
	No hazardous substances above threshold values

High-current terminal block - PTPOWER 35

3212064

<https://www.phoenixcontact.com/de/produkte/3212064>

Accessories

 Note: Applying some accessories below might limit this product.

Plug-in bridge

Plug-in bridge - FBS 2-16 - 3005963

<https://www.phoenixcontact.com/de/produkte/3005963>



Plug-in bridge, pitch: 16 mm, color: red

 Max. current carrying capacity: 101 A

Reducing bridge

Reducing bridge - RB PTPOWER 35-ST 16 - 3032170

<https://www.phoenixcontact.com/de/produkte/3032170>



Reducing bridge, For bridging PTPOWER 35 to ST 16... or PT 16 N terminal blocks, pitch: 14.5 mm, color: red

 Max. current carrying capacity: 90 A

High-current terminal block - PTPOWER 35

3212064

<https://www.phoenixcontact.com/de/produkte/3212064>

Reducing bridge

Reducing bridge - RB PTPOWER 35-ST(2,5/4) - 3030900

<https://www.phoenixcontact.com/de/produkte/3030900>



Reducing bridge, for bridging of PTPOWER 35 to ST or PT ..N terminal blocks with nominal cross section of 2.5 mm² and 4 mm², pitch: 10.8 mm, color: red

 Max. current carrying capacity: 35 A

Screwdriver

Screwdriver - SZF 3-1,0X5,5 - 1206612

<https://www.phoenixcontact.com/de/produkte/1206612>



Actuation tool, for ST terminal blocks, also suitable for use as a bladed screwdriver, size: 1.0 x 5.5 x 150 mm, 2-component grip, with non-slip grip

High-current terminal block - PTPOWER 35

3212064

<https://www.phoenixcontact.com/de/produkte/3212064>

DIN rail perforated

DIN rail perforated - NS 35/15 PERF 2000MM - 1201730

<https://www.phoenixcontact.com/de/produkte/1201730>



DIN rail perforated, similar to EN 60715, material: Steel, galvanized, passivated with a thick layer, Standard profile, color: silver, Pack of 25 (50 m)

Crimping pliers

Crimping pliers - CRIMPFOX CENTRUS 6S - 1213144

<https://www.phoenixcontact.com/de/produkte/1213144>



Crimping pliers, for uninsulated and insulated ferrules, DIN 46228 Part 1 and 4, from 0.14 mm² ... 6 mm², also for TWIN ferrules up to 2 x 4 mm², automatic cross section adjustment, lateral insertion, equipped with fall protection

High-current terminal block - PTPOWER 35

3212064

<https://www.phoenixcontact.com/de/produkte/3212064>

DIN rail, unperforated

DIN rail, unperforated - NS 35/15 UNPERF 2000MM - 1201714

<https://www.phoenixcontact.com/de/produkte/1201714>



DIN rail, unperforated, similar to EN 60715, material: Steel, galvanized, passivated with a thick layer, Standard profile, color: silver, Pack of 25 (50 m)

Crimping pliers

Crimping pliers - CRIMPFOX CENTRUS 10S - 1213154

<https://www.phoenixcontact.com/de/produkte/1213154>



Crimping pliers, for uninsulated and insulated ferrules, DIN 46228 Part 1 and 4, from 0.14 mm² ... 10 mm², also for TWIN ferrules up to 2 x 4 mm², automatic cross section adjustment, lateral insertion, equipped with fall protection

High-current terminal block - PTPOWER 35

3212064

<https://www.phoenixcontact.com/de/produkte/3212064>

DIN rail perforated

DIN rail perforated - NS 35/15 WH PERF 2000MM - 0806602

<https://www.phoenixcontact.com/de/produkte/0806602>



DIN rail perforated, similar to EN 60715, material: Steel, Galvanized, white passivated, Standard profile, color: white, Pack of 25 (50 m)

Crimping pliers

Crimping pliers - CRIMPFOX CENTRUS 6H - 1213146

<https://www.phoenixcontact.com/de/produkte/1213146>



Crimping pliers, for uninsulated and insulated ferrules, DIN 46228 Part 1 and 4, from 0.14 mm² ... 6 mm², also for TWIN ferrules up to 2 x 4 mm², automatic cross section adjustment, lateral insertion, equipped with fall protection

High-current terminal block - PTPOWER 35

3212064

<https://www.phoenixcontact.com/de/produkte/3212064>

DIN rail, unperforated

DIN rail, unperforated - NS 35/15 WH UNPERF 2000MM-VPE 10 - 1204135

<https://www.phoenixcontact.com/de/produkte/1204135>



DIN rail, unperforated, similar to EN 60715, material: Steel, Galvanized, white passivated, Standard profile, color: silver, Pack of 10 (20 m)

Crimping pliers

Crimping pliers - CRIMPFOX CENTRUS 10H - 1213156

<https://www.phoenixcontact.com/de/produkte/1213156>



Crimping pliers, for uninsulated and insulated ferrules, DIN 46228 Part 1 and 4, from 0.14 mm² ... 10 mm², also for TWIN ferrules up to 2 x 4 mm², automatic cross section adjustment, lateral insertion, equipped with fall protection

High-current terminal block - PTPOWER 35

3212064

<https://www.phoenixcontact.com/de/produkte/3212064>

DIN rail, unperforated

DIN rail, unperforated - NS 35/15 AL UNPERF 2000MM - 1201756

<https://www.phoenixcontact.com/de/produkte/1201756>



DIN rail, unperforated, similar to EN 60715, material: Aluminum, uncoated, Standard profile, color: silver

Crimping pliers

Crimping pliers - CRIMPFOX 10S - 1212045

<https://www.phoenixcontact.com/de/produkte/1212045>



Crimping pliers, for ferrules without insulating collar according to DIN 46228 Part 1 and ferrules with insulating collar according to DIN 46228 Part 4, 0.14 mm² ... 10 mm², unlockable pressure lock, lateral entry

High-current terminal block - PTPOWER 35

3212064

<https://www.phoenixcontact.com/de/produkte/3212064>

DIN rail perforated

DIN rail perforated - NS 35/15 ZN PERF 2000MM - 1206599

<https://www.phoenixcontact.com/de/produkte/1206599>



DIN rail perforated, similar to EN 60715, material: Steel, galvanized, Standard profile, color: silver, Pack of 25 (50 m)

Crimping pliers

Crimping pliers - CRIMPFOX 6H - 1212046

<https://www.phoenixcontact.com/de/produkte/1212046>



Crimping pliers, for ferrules without insulating collar according to DIN 46228 Part 1 and ferrules with insulating collar according to DIN 46228 Part 4, 0.14 mm² ... 6 mm², unlockable pressure lock, lateral entry

High-current terminal block - PTPOWER 35

3212064

<https://www.phoenixcontact.com/de/produkte/3212064>

DIN rail, unperforated

DIN rail, unperforated - NS 35/15 ZN UNPERF 2000MM - 1206586

<https://www.phoenixcontact.com/de/produkte/1206586>



DIN rail, unperforated, similar to EN 60715, material: Steel, galvanized, Standard profile, color: silver, Pack of 25 (50 m)

Crimping pliers

Crimping pliers - CRIMPFOX 2,5-M - 1212719

<https://www.phoenixcontact.com/de/produkte/1212719>



Crimping pliers, for ferrules without insulating collar according to DIN 46228 Part 1 and ferrules with insulating collar according to DIN 46228 Part 4, 0.25 mm² ... 2.5 mm², lateral entry, trapezoidal crimp

High-current terminal block - PTPOWER 35

3212064

<https://www.phoenixcontact.com/de/produkte/3212064>

DIN rail, unperforated

DIN rail, unperforated - NS 35/15 CU UNPERF 2000MM-VPE 10 - 1201895

<https://www.phoenixcontact.com/de/produkte/1201895>



DIN rail, unperforated, similar to EN 60715, material: Copper, uncoated, Standard profile, color: copper-colored, Pack of 10 (20 m)

Crimping pliers

Crimping pliers - CRIMPFOX 6-M - 1212720

<https://www.phoenixcontact.com/de/produkte/1212720>



Crimping pliers, for ferrules without insulating collar according to DIN 46228 Part 1 and ferrules with insulating collar according to DIN 46228 Part 4, 0.25 mm² ... 6.0 mm², lateral entry, trapezoidal crimp

High-current terminal block - PTPOWER 35

3212064

<https://www.phoenixcontact.com/de/produkte/3212064>

End cap

End cap - NS 35/15 CAP - 1206573

<https://www.phoenixcontact.com/de/produkte/1206573>

DIN rail end piece, for DIN rail NS 35/15



Crimping pliers

Crimping pliers - CRIMPFOX 6 - 1212034

<https://www.phoenixcontact.com/de/produkte/1212034>



Crimping pliers, for ferrules without insulating collar according to DIN 46228 Part 1 and ferrules with insulating collar according to DIN 46228 Part 4, 0.25 mm² ... 6.0 mm², lateral entry, trapezoidal crimp

High-current terminal block - PTPOWER 35

3212064

<https://www.phoenixcontact.com/de/produkte/3212064>

End clamp

End clamp - E/AL-NS 35 - 1201662

<https://www.phoenixcontact.com/de/produkte/1201662>



End clamp, for end support of UKH 50 to UKH 240, is pushed onto DIN rail NS 35 and fixed with 2 screws, width: 10 mm, color: aluminum

Crimping pliers

Crimping pliers - CRIMPFOX 6T - 1212037

<https://www.phoenixcontact.com/de/produkte/1212037>



Crimping pliers, for ferrules without insulating collar according to DIN 46228 Part 1 and ferrules with insulating collar according to DIN 46228 Part 4, 0.25 mm² ... 6 mm², lateral entry, trapezoidal crimp

High-current terminal block - PTPOWER 35

3212064

<https://www.phoenixcontact.com/de/produkte/3212064>

Marker for terminal blocks

Marker for terminal blocks - TMT (EX9,5)R - 0828295

<https://www.phoenixcontact.com/de/produkte/0828295>



Marker for terminal blocks, Roll, white, unlabeled, can be labeled with: THERMOMARK ROLL 2.0, THERMOMARK ROLL, THERMOMARK ROLL X1, THERMOMARK ROLLMASTER 300/600, THERMOMARK X1.2, mounting type: snapped, snap into tall marker groove, for terminal block width: 50000 mm, lettering field size: 9.5 x 50000 mm, Number of individual labels: 1

Crimping pliers

Crimping pliers - CRIMPFOX 6T-F - 1212038

<https://www.phoenixcontact.com/de/produkte/1212038>



Crimping pliers, for ferrules without insulating collar according to DIN 46228 Part 1 and ferrules with insulating collar according to DIN 46228 Part 4, 0.25 mm² ... 6 mm², front entry, trapezoidal crimp

High-current terminal block - PTPOWER 35

3212064

<https://www.phoenixcontact.com/de/produkte/3212064>

Marker for terminal blocks

Marker for terminal blocks - US-TM 100 - 0829255

<https://www.phoenixcontact.com/de/produkte/0829255>



Marker for terminal blocks, Card, white, unlabeled, can be labeled with: BLUEMARK ID COLOR, BLUEMARK ID, THERMOMARK PRIME, THERMOMARK CARD 2.0, THERMOMARK CARD, mounting type: snapped, lettering field size: 104 x 9.8 mm, Number of individual labels: 13

Crimping pliers

Crimping pliers - CRIMPFOX 6S-F - 1212043

<https://www.phoenixcontact.com/de/produkte/1212043>



Crimping pliers, for ferrules without insulating collar according to DIN 46228 Part 1 and ferrules with insulating collar according to DIN 46228 Part 4, 0.5 mm² ... 6 mm², front entry, square crimp

High-current terminal block - PTPOWER 35

3212064

<https://www.phoenixcontact.com/de/produkte/3212064>

Zack Marker strip, flat

Zack Marker strip, flat - ZBF10:UNBEDRUCKT - 0809997

<https://www.phoenixcontact.com/de/produkte/0809997>



Zack Marker strip, flat, Strip, white, unlabeled, can be labeled with: CMS-P1-PLOTTER, PLOTMARK, mounting type: snapped, for terminal block width: 10 mm, lettering field size: 5.15 x 10 mm, Number of individual labels: 10

Crimping pliers

Crimping pliers - CRIMPFOX 10 - 1212721

<https://www.phoenixcontact.com/de/produkte/1212721>



Crimping pliers, for ferrules without insulating collar according to DIN 46228 Part 1 and ferrules with insulating collar according to DIN 46228 Part 4, 4 mm² ... 10 mm², lateral entry, trapezoidal crimp

High-current terminal block - PTPOWER 35

3212064

<https://www.phoenixcontact.com/de/produkte/3212064>

Zack Marker strip, flat

Zack Marker strip, flat - ZBF10 CUS - 0825031

<https://www.phoenixcontact.com/de/produkte/0825031>



Zack Marker strip, flat, can be ordered: Strip, white, labeled according to customer specifications, mounting type: snap into flat marker groove, for terminal block width: 10 mm, lettering field size: 5.15 x 10 mm, Number of individual labels: 10

Crimping pliers

Crimping pliers - CRIMPFOX 25R - 1212039

<https://www.phoenixcontact.com/de/produkte/1212039>



Crimping pliers, for ferrules without insulating collar according to DIN 46228 Part 1 and ferrules with insulating collar according to DIN 46228 Part 4, 10 mm² ... 25 mm², lateral entry, WM crimp

High-current terminal block - PTPOWER 35

3212064

<https://www.phoenixcontact.com/de/produkte/3212064>

Zack Marker strip, flat

Zack Marker strip, flat - ZBF10,LGS:FORTL.ZAHLEN - 0810009

<https://www.phoenixcontact.com/de/produkte/0810009>



Zack Marker strip, flat, Strip, white, labeled, printed horizontally: consecutive numbers 1 ... 10, 11 ... 20, etc. up to 91 ... 100, mounting type: snapped, for terminal block width: 10 mm, lettering field size: 5.15 x 10 mm, Number of individual labels: 10

Crimping pliers

Crimping pliers - CRIMPFOX 50R - 1212041

<https://www.phoenixcontact.com/de/produkte/1212041>



Crimping pliers, for ferrules without insulating collar according to DIN 46228 Part 1 and ferrules with insulating collar according to DIN 46228 Part 4, 35 mm² ... 50 mm², lateral entry, WM crimp

High-current terminal block - PTPOWER 35

3212064

<https://www.phoenixcontact.com/de/produkte/3212064>

Zack Marker strip, flat

Zack Marker strip, flat - ZBF10,QR:FORTL.ZAHLEN - 0810025

<https://www.phoenixcontact.com/de/produkte/0810025>



Zack Marker strip, flat, Strip, white, labeled, Printed vertically: consecutive numbers 1 ... 10, 11 ... 20, etc. up to 91 ... 100, mounting type: snapped, for terminal block width: 10 mm, lettering field size: 5.15 x 10 mm, Number of individual labels: 10

Crimping pliers

Crimping pliers - CRIMPFOX-M - 1212072

<https://www.phoenixcontact.com/de/produkte/1212072>



Basic pliers, for accommodating dies for a wide range of type of contacts

High-current terminal block - PTPOWER 35

3212064

<https://www.phoenixcontact.com/de/produkte/3212064>

Marker for terminal blocks

Marker for terminal blocks - UC-TMF 10 - 0818124

<https://www.phoenixcontact.com/de/produkte/0818124>



Marker for terminal blocks, Sheet, white, unlabeled, can be labeled with: BLUEMARK ID COLOR, BLUEMARK ID, BLUEMARK CLED, PLOTMARK, CMS-P1-PLOTTER, mounting type: snapped, for terminal block width: 10.2 mm, lettering field size: 9.6 x 5.1 mm, Number of individual labels: 48

Cover

Cover - CEC PTPOWER 35/50 - 1056086

<https://www.phoenixcontact.com/de/produkte/1056086>



Cover, yellow, labeled: Lightning flash, mounting type: plug in

High-current terminal block - PTPOWER 35

3212064

<https://www.phoenixcontact.com/de/produkte/3212064>

Marker for terminal blocks

Marker for terminal blocks - UC-TMF 10 CUS - 0824662

<https://www.phoenixcontact.com/de/produkte/0824662>



Marker for terminal blocks, can be ordered: by sheet, white, labeled according to customer specifications, mounting type: snap into flat marker groove, for terminal block width: 10.2 mm, lettering field size: 9.6 x 5.1 mm, Number of individual labels: 48

Test adapter

Test adapter - PAI-ST 35/1000MM - 3029994

<https://www.phoenixcontact.com/de/produkte/3029994>



Test adapter, color: red

High-current terminal block - PTPOWER 35



3212064

<https://www.phoenixcontact.com/de/produkte/3212064>

Marker for terminal blocks

Marker for terminal blocks - UCT-TMF 10 - 0829204

<https://www.phoenixcontact.com/de/produkte/0829204>



Marker for terminal blocks, Sheet, white, unlabeled, can be labeled with: TOPMARK NEO, TOPMARK LASER, BLUEMARK ID COLOR, BLUEMARK ID, BLUEMARK CLED, THERMOMARK PRIME, THERMOMARK CARD 2.0, THERMOMARK CARD, mounting type: snapped, for terminal block width: 10.2 mm, lettering field size: 9.4 x 4.7 mm, Number of individual labels: 36

Mounting material

Mounting material - PTPOWER-IL - 1180891

<https://www.phoenixcontact.com/de/produkte/1180891>

Operating decal for the PTPOWER



High-current terminal block - PTPOWER 35

3212064

<https://www.phoenixcontact.com/de/produkte/3212064>

Marker for terminal blocks

Marker for terminal blocks - UCT-TMF 10 CUS - 0829679

<https://www.phoenixcontact.com/de/produkte/0829679>



Marker for terminal blocks, can be ordered: by sheet, white, labeled according to customer specifications, mounting type: snap into flat marker groove, for terminal block width: 10.2 mm, lettering field size: 9.4 x 4.7 mm, Number of individual labels: 36

Zack marker strip

Zack marker strip - ZB 10:UNBEDRUCKT - 1053001

<https://www.phoenixcontact.com/de/produkte/1053001>

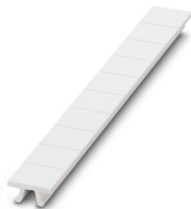

Zack marker strip, Strip, white, unlabeled, can be labeled with: PLOTMARK, CMS-P1-PLOTTER, mounting type: snapped, for terminal block width: 10.2 mm, lettering field size: 10.5 mm x 10.15 mm, Number of individual labels: 10

High-current terminal block - PTPOWER 35

3212064

<https://www.phoenixcontact.com/de/produkte/3212064>

Zack marker strip

Zack marker strip - ZB 10 CUS - 0824941

<https://www.phoenixcontact.com/de/produkte/0824941>



Zack marker strip, can be ordered: Strip, white, labeled according to customer specifications, mounting type: snap into tall marker groove, for terminal block width: 10.2 mm, lettering field size: 10.15 x 10.5 mm, Number of individual labels: 10

Zack marker strip

Zack marker strip - ZB10,LGS:FORTL.ZAHLEN - 1053014

<https://www.phoenixcontact.com/de/produkte/1053014>



Zack marker strip, Strip, white, labeled, can be labeled with: CMS-P1-PLOTTER, printed horizontally: consecutive numbers 1 ... 10, 11 ... 20, etc. up to 91 ... 100, mounting type: snapped, for terminal block width: 10.2 mm, lettering field size: 10.15 x 10.5 mm, Number of individual labels: 10

High-current terminal block - PTPOWER 35

3212064

<https://www.phoenixcontact.com/de/produkte/3212064>

Zack marker strip

Zack marker strip - ZB10,QR:FORTL.ZAHLEN - 1053027

<https://www.phoenixcontact.com/de/produkte/1053027>



Zack marker strip, Strip, white, labeled, can be labeled with: CMS-P1-PLOTTER, Printed vertically: consecutive numbers 1 ... 10, 11 ... 20, etc. up to 91 ... 100, mounting type: snapped, for terminal block width: 10.2 mm, lettering field size: 10.15 x 10.5 mm, Number of individual labels: 10

Marker for terminal blocks

Marker for terminal blocks - ZB10,LGS:L1-N,PE - 1053412

<https://www.phoenixcontact.com/de/produkte/1053412>

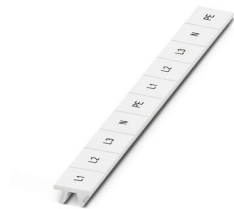

Marker for terminal blocks, Strip, white, labeled, can be labeled with: CMS-P1-PLOTTER, horizontal: L1, L2, L3, N, PE, L1, L2, L3, N, PE, mounting type: snapped, for terminal block width: 10.2 mm, lettering field size: 10.15 x 10.5 mm, Number of individual labels: 10

High-current terminal block - PTPOWER 35

3212064

<https://www.phoenixcontact.com/de/produkte/3212064>

Marker for terminal blocks

Marker for terminal blocks - ZB10,LGS:U-N - 1053438

<https://www.phoenixcontact.com/de/produkte/1053438>



Marker for terminal blocks, Strip, white, labeled, can be labeled with: CMS-P1-PLOTTER, horizontal: U, V, W, N, GND, U, V, W, N, GND, mounting type: snapped, for terminal block width: 10.2 mm, lettering field size: 10.15 x 10.5 mm, Number of individual labels: 10

Marker for terminal blocks

Marker for terminal blocks - UC-TM 10 - 0818069

<https://www.phoenixcontact.com/de/produkte/0818069>



Marker for terminal blocks, Sheet, white, unlabeled, can be labeled with: BLUEMARK ID COLOR, BLUEMARK ID, BLUEMARK CLED, PLOTMARK, CMS-P1-PLOTTER, mounting type: snapped, for terminal block width: 10.2 mm, lettering field size: 9.6 x 10.5 mm, Number of individual labels: 48

High-current terminal block - PTPOWER 35

3212064

<https://www.phoenixcontact.com/de/produkte/3212064>

Marker for terminal blocks

Marker for terminal blocks - UC-TM 10 CUS - 0824605

<https://www.phoenixcontact.com/de/produkte/0824605>



Marker for terminal blocks, can be ordered: by sheet, white, labeled according to customer specifications, mounting type: snap into tall marker groove, for terminal block width: 10.2 mm, lettering field size: 9.6 x 10.5 mm, Number of individual labels: 48

Marker for terminal blocks

Marker for terminal blocks - UCT-TM 10 - 0829142

<https://www.phoenixcontact.com/de/produkte/0829142>



Marker for terminal blocks, Sheet, white, unlabeled, can be labeled with: TOPMARK NEO, TOPMARK LASER, BLUEMARK ID COLOR, BLUEMARK ID, BLUEMARK CLED, THERMOMARK PRIME, THERMOMARK CARD 2.0, THERMOMARK CARD, mounting type: snapped, for terminal block width: 10.2 mm, lettering field size: 8.9 x 9.6 mm, Number of individual labels: 36

High-current terminal block - PTPOWER 35

3212064

<https://www.phoenixcontact.com/de/produkte/3212064>

Marker for terminal blocks

Marker for terminal blocks - UCT-TM 10 CUS - 0829623

<https://www.phoenixcontact.com/de/produkte/0829623>



Marker for terminal blocks, can be ordered: by sheet, white, labeled according to customer specifications, mounting type: snap into tall marker groove, for terminal block width: 10.2 mm, lettering field size: 8.9 x 9.6 mm, Number of individual labels: 36

Software

Software - PROJECT COMPLETE - 1050453

<https://www.phoenixcontact.com/de/produkte/1050453>

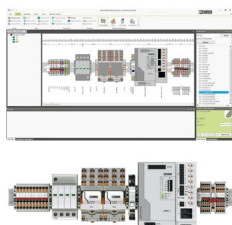

Intuitive planning and marking software for configuring terminal strips and for professional marking of marking materials for terminal blocks, conductors, cables, devices, and systems. The software is available for download

High-current terminal block - PTPOWER 35

3212064

<https://www.phoenixcontact.com/de/produkte/3212064>

Ferrule

Ferrule - A 10 -25 - 1090628

<https://www.phoenixcontact.com/de/produkte/1090628>



Ferrule, length: 25 mm, color: silver

Ferrule

Ferrule - A 16 -25 - 1090632

<https://www.phoenixcontact.com/de/produkte/1090632>



Ferrule, length: 25 mm, color: silver

High-current terminal block - PTPOWER 35

3212064

<https://www.phoenixcontact.com/de/produkte/3212064>

Ferrule

Ferrule - A 25 -25 - 1090634

<https://www.phoenixcontact.com/de/produkte/1090634>

Ferrule, length: 25 mm, color: silver



Ferrule

Ferrule - AI 35 -25 RD - 3200713

<https://www.phoenixcontact.com/de/produkte/3200713>

Ferrule, sleeve length: 25 mm, length: 39 mm, color: red



Phoenix Contact 2022 © - all rights reserved
<https://www.phoenixcontact.com>

PHOENIX CONTACT Deutschland GmbH
Flachsmarktstraße 8
D-32825 Blomberg
+49 52 35/3-1 20 00
info@phoenixcontact.de