

Single relay - REL-IR4/LDP- 24DC/4X21

2903677

<https://www.phoenixcontact.com/de/produkte/2903677>

Please be informed that the data shown in this PDF document is generated from our Online Catalog. Please find the complete data in the user documentation. Our General Terms of Use for Downloads are valid.



Plug-in industrial relay with power contacts, 4 changeover contacts, test button, status LED, freewheeling diode, mechanical switching position indicator, polarity: A1+, A2-, input voltage: 24 V DC

Single relay - REL-IR4/LDP- 24DC/4X21



2903677

<https://www.phoenixcontact.com/de/produkte/2903677>

Commercial Data

Item number	2903677
Packing unit	10 pc
Minimum order quantity	10 pc
Note	Made to Order (non-returnable)
Sales Key	G1 - Relais
Product Key	CK6193
Catalog Page	Page 300 (C-5-2019)
GTIN	4046356758901
Weight per Piece (including packing)	35,7 g
Weight per Piece (excluding packing)	34,4 g
Customs tariff number	85364190
Country of origin	PL

Single relay - REL-IR4/LDP- 24DC/4X21



2903677

<https://www.phoenixcontact.com/de/produkte/2903677>

Technical Data

Product properties

Product type	Single relay
Set comprises	2903308 RIF-2-RPT-LDP-24DC/4X21
	2903320 RIF-2-RSC-LDP-24DC/4X21
Operating mode	100% operating factor
Mechanical service life	approx. 2×10^7 cycles

Insulation characteristics

Overvoltage category	II
Pollution degree	2
Insulation	Basic insulation

Electrical properties

Service life electrical	see diagram
Maximum power dissipation for nominal condition	1.01 W
Test voltage	2.5 kV _{rms} (50 Hz, 1 min., winding/contact)
Test voltage Changeover contact/changeover contact	2 kV _{rms} (50 Hz, 1 min., changeover contact/changeover contact)
Rated insulation voltage	250 V AC
Rated surge voltage	2.5 kV

Input data

Coil side

Nominal input voltage U_N	24 V DC
Input voltage range	18.7 V DC ... 46.8 V DC (20 °C)
Typical input current at U_N	42 mA
Typical response time	13 ms
Typical release time	14 ms
Protective circuit	Freewheeling diode
Status display	Yellow LED

Output data

Switching

Contact type	4 changeover contacts
Type of switch contact	Single contact
Drive and function	monostable
Contact material	AgNi
Maximum switching voltage	250 V AC/DC
Minimum switching voltage	5 V (At 24 mA)
Limiting continuous current	6 A
Maximum inrush current	16 A (20 ms, N/O contacts)
Min. switching current	5 mA (at 24 V)

Single relay - REL-IR4/LDP- 24DC/4X21



2903677

<https://www.phoenixcontact.com/de/produkte/2903677>

Interrupting rating (ohmic load) max.	144 W (at 24 V DC)
	124 W (at 48 V DC)
	108 W (at 60 V DC)
	52 W (at 110 V DC)
	48 W (at 220 V DC)
	1500 VA (for 250 V AC)
Switching capacity min.	0.12 W
Switching capacity	2 A (at 24 V, DC13)
	0.22 A (at 120 V, DC13)
	0.11 A (at 250 V, DC13)
	1.5 A (at 24 V, AC15)
	1.5 A (at 120 V, AC15)
1 A (at 240 V, AC15)	
Motor load according to UL 508	1/3 HP, 240 V AC

Connection data

Connection method	Plug-in connection
-------------------	--------------------

Dimensions

Width	21.2 mm
Height	27.5 mm
Depth	35.6 mm

Environmental and real-life conditions

Ambient conditions

Degree of protection	RT I
Ambient temperature (operation)	-40 °C ... 70 °C
Ambient temperature (storage/transport)	-40 °C ... 85 °C

Approval data

Corrosive gas test

Identification	ISA-S71.04. G3 Harsh Group
	EN 60068-2-60

Standards and regulations

Standards/regulations	IEC 60664
	IEC 61810

Mounting

Mounting position	any
-------------------	-----

Drawings

Diagram

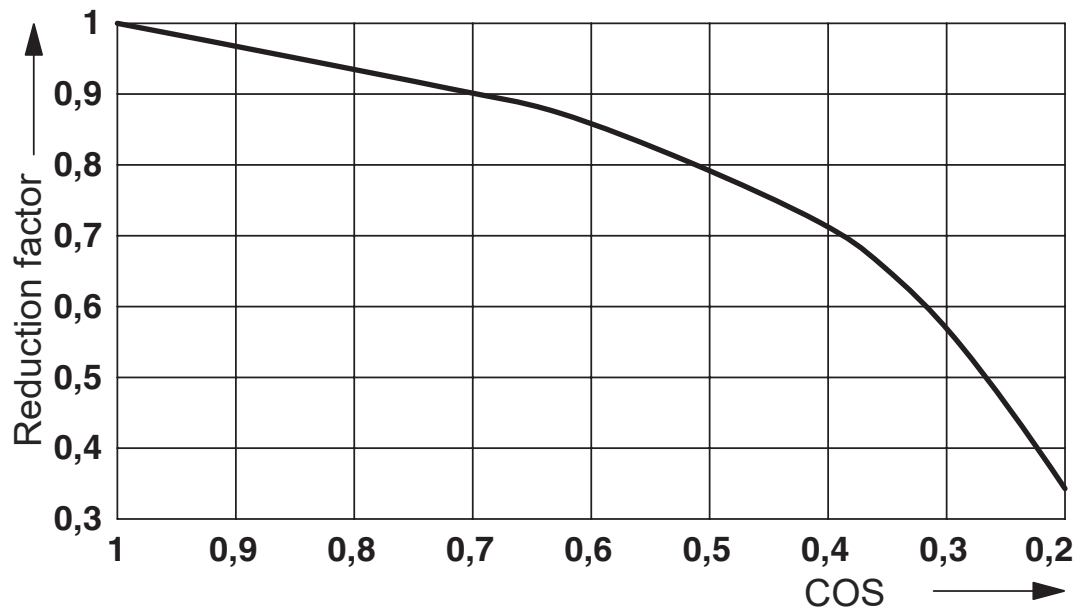

Service life reduction factor

Single relay - REL-IR4/LDP- 24DC/4X21

2903677

<https://www.phoenixcontact.com/de/produkte/2903677>

Diagram

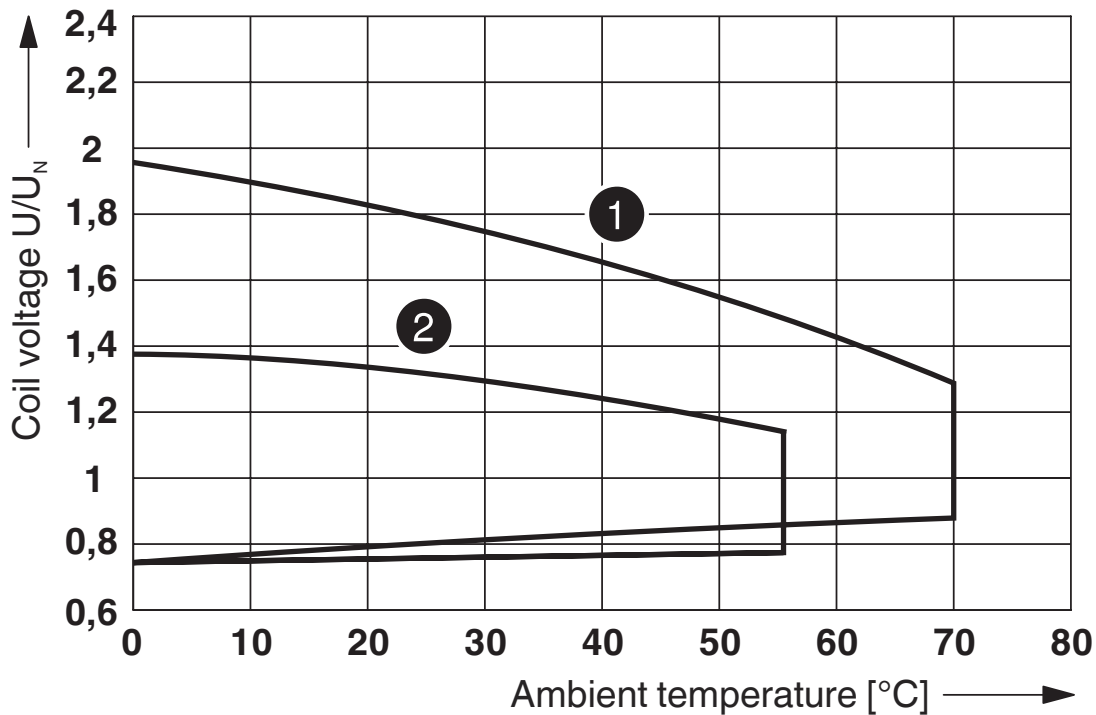

- ① DC coils
- ② AC coils

Operating voltage range

Circuit diagram

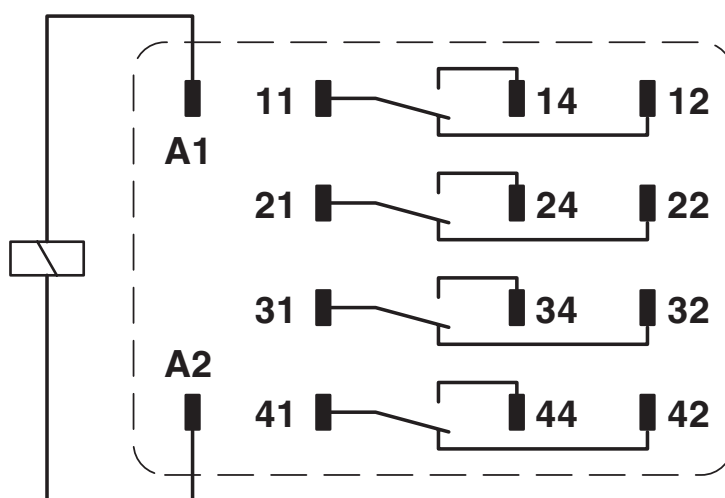

Single relay - REL-IR4/LDP- 24DC/4X21

2903677

<https://www.phoenixcontact.com/de/produkte/2903677>

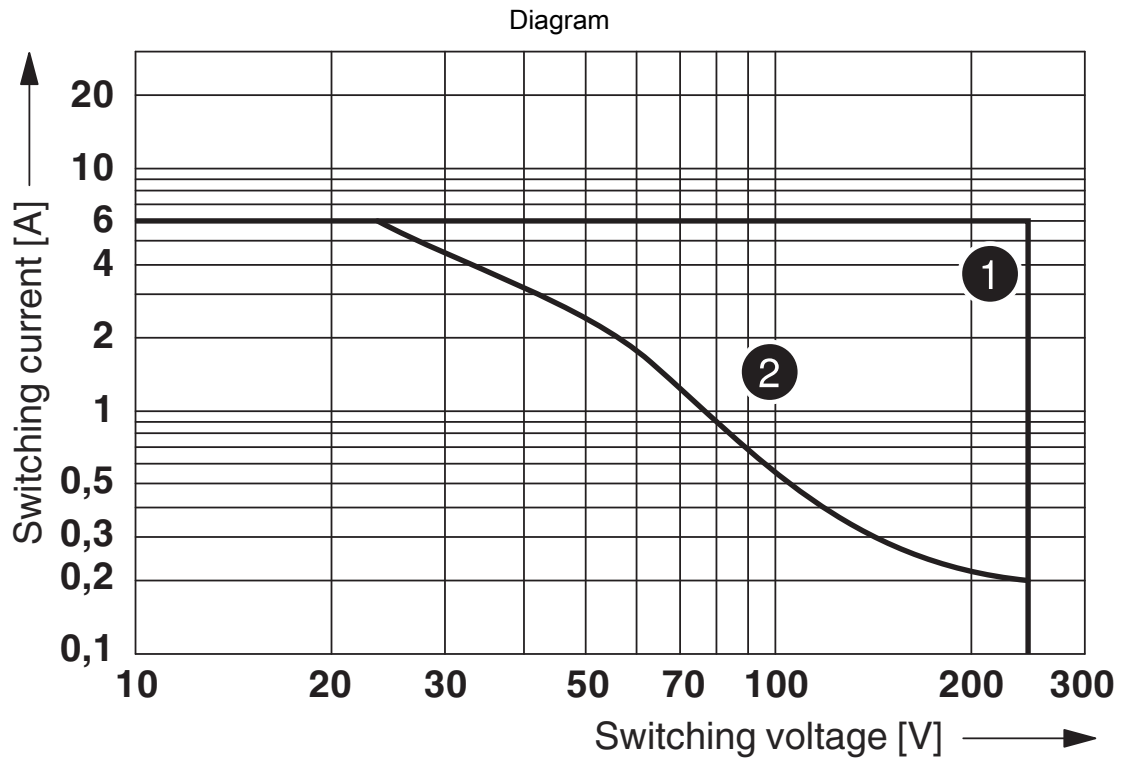

- ① AC, ohmic load
- ② DC, ohmic load

Interrupting rating

Single relay - REL-IR4/LDP- 24DC/4X21

2903677

<https://www.phoenixcontact.com/de/produkte/2903677>

Diagram

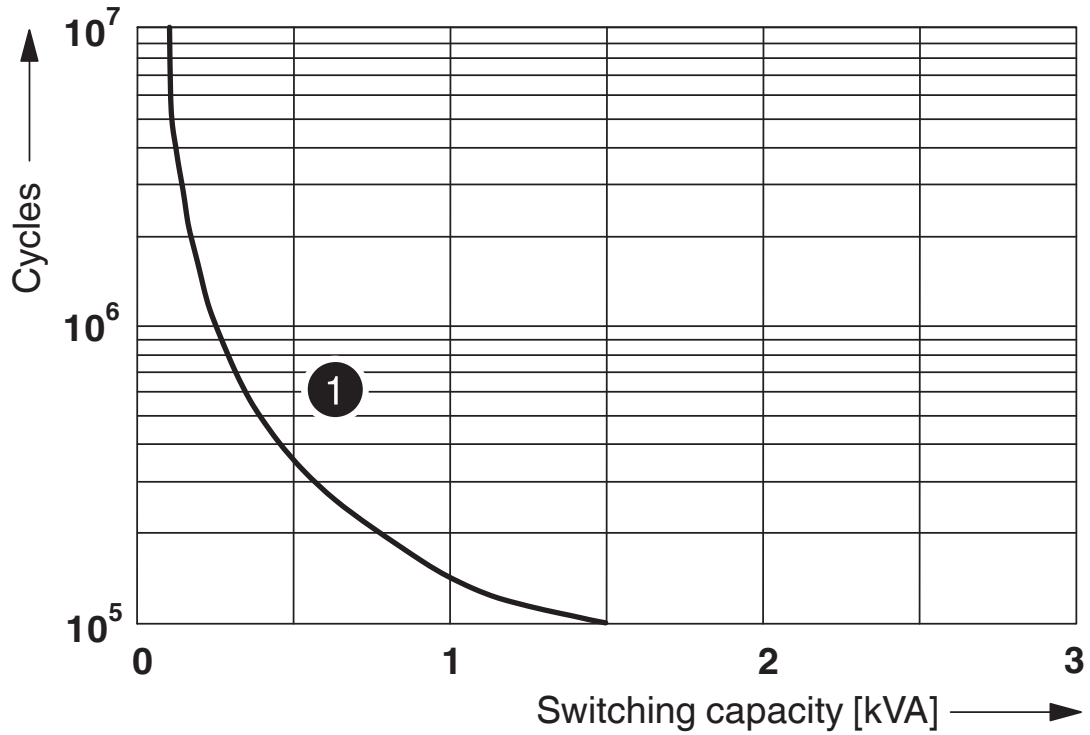

① 250 V AC, Ohmic load

Electrical service life

Single relay - REL-IR4/LDP- 24DC/4X21



2903677

<https://www.phoenixcontact.com/de/produkte/2903677>

Approvals

 **CSA**
Approval ID: 2554095

 **cUL Recognized**
Approval ID: FILE E 172140

 **UL Recognized**
Approval ID: FILE E 172140

 **EAC**
Approval ID: TR_TS_D_00573_c

 **VDE Zeichengenehmigung**
Approval ID: 40040427

cULus Recognized

Single relay - REL-IR4/LDP- 24DC/4X21



2903677

<https://www.phoenixcontact.com/de/produkte/2903677>

Classifications

ECLASS

ECLASS-9.0	27371601
ECLASS-10.0.1	27371601
ECLASS-11.0	27371601

ETIM

ETIM 8.0	EC001437
----------	----------

UNSPSC

UNSPSC 21.0	39122300
-------------	----------

Single relay - REL-IR4/LDP- 24DC/4X21



2903677

<https://www.phoenixcontact.com/de/produkte/2903677>

Environmental Product Compliance

China RoHS	Environmentally friendly use period: unlimited = EFUP-e
	No hazardous substances above threshold values

Single relay - REL-IR4/LDP- 24DC/4X21



2903677

<https://www.phoenixcontact.com/de/produkte/2903677>

Accessories

Relay base

Relay base - RIF-2-BPT/4X21 - 2900934

<https://www.phoenixcontact.com/de/produkte/2900934>



Relay base RIF-2..., for industrial relay with 2 or 4 changeover contacts, Push-in connection, plug-in option for input/interference suppression modules, for mounting on NS 35/7,5

Relay base

Relay base - RIF-2-BSC/4X21 - 2900932

<https://www.phoenixcontact.com/de/produkte/2900932>



RIF-2... relay base, for industrial relay with 2 or 4 changeover contacts, screw connection, plug-in option for input/interference suppression modules, for mounting on NS 35/7,5

Phoenix Contact 2022 © - all rights reserved

<https://www.phoenixcontact.com>

PHOENIX CONTACT Deutschland GmbH

Flachsmarktstraße 8

D-32825 Blomberg

+49 52 35/3-1 20 00

info@phoenixcontact.de