

Contact insert - HC-DD72-I-CT-F



1584091

<https://www.phoenixcontact.com/pc/products/1584091>

Please be informed that the data shown in this PDF document is generated from our Online Catalog. Please find the complete data in the user documentation. Our General Terms of Use for Downloads are valid.

HEAVYCON female insert, DD72 series, 72-pos., crimp connection



Your advantages

- Can be used in rail vehicles, satisfy DIN EN 45545-2 with requirement sets R22, R23, and R24 in hazard levels HL1, HL2, and HL3.

Contact insert - HC-DD72-I-CT-F



1584091

<https://www.phoenixcontact.com/pc/products/1584091>

Commercial Data

Item number	1584091
Packing unit	1 pc
Minimum order quantity	1 pc
Product Key	BF7ABF
Catalog Page	Page 539 (C-2-2019)
GTIN	4046356133401
Weight per Piece (including packing)	61 g
Weight per Piece (excluding packing)	60.4 g
Customs tariff number	85389099
Country of origin	CN

Contact insert - HC-DD72-I-CT-F



1584091

<https://www.phoenixcontact.com/pc/products/1584091>

Technical Data

Notes

General	For HEAVYCON ADVANCE and HEAVYCON housing of type B16, crimp contacts: CK 1,6-ED... (not included in scope of supply)
General	Connectors may be operated only when there is no load/voltage.
General	It is imperative that guide pins (HC-CST) and sockets (HC-CBU) are used to prevent tip collision due to misalignment.

Product properties

Type	B16 B32
Product type	Contact insert with a fixed no. of positions
Number of positions	72
Connection profile	72+PE
Application	Signal
Number of connections per position	1
Contact type	turned rolled
Series	HC-DD

Insulation characteristics

Overvoltage category	III
Degree of pollution	3

Connection data

Connection technology

Connection technology	Crimp connection
Number of connections per position	1
Connection in acc. with standard	IEC / EN

Conductor connection

Connection cross section AWG	26 ... 14
Stripping length of the individual wire	8 mm (0.14 ... 1.5 mm ²) 6 mm (2.5 mm ²)

Dimensions

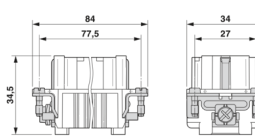
Dimensional drawing	
Width	34 mm
Height	34.5 mm

Contact insert - HC-DD72-I-CT-F



1584091

<https://www.phoenixcontact.com/pc/products/1584091>

Length	84 mm
Drill hole distance, horizontal	77.5 mm
Drill hole distance, vertical	27 mm

Mechanical characteristics

Minimum housing height	72 mm
Contact diameter	1.6 mm

Electrical properties

Rated voltage (III/3)	250 V
Rated surge voltage	4 kV
Rated current	10 A
SCCR	5 kA (UL 2237)

Material specifications

Flammability rating according to UL 94	V0
Contact material	Copper alloy
Contact surface material	Ag (alternatively Au)
Contact carrier material	PC
Standards/regulations	PC: Fire protection in rail vehicles - requirement sets R22, R23, and R24 acc. to DIN EN 45545-2 (Risk level HL1 - HL3)

Connector

Insertion/withdrawal cycles	≥ 500
-----------------------------	-------

Cable / line

Cable structure

Stripping length of the individual wire	8 mm (0.14 ... 1.5 mm ²)
	6 mm (2.5 mm ²)

Mounting

Assembly instructions	To ensure correct use, installation in housing with IP54 protection or better is required
-----------------------	---

Ambient conditions

Ambient temperature (operation)	-40 °C ... 125 °C (including heating up of contacts)
---------------------------------	--

Standards and regulations

Constructional and testing regulations	DIN VDE 0627/86
	DIN VDE 0110/02.79
	DIN VDE 0110-1/04.97
	IEC 60664-1, DIN IEC 60512
	IEC 60352
Tests	DIN VDE 0627/86
	DIN VDE 0110/02.79

Contact insert - HC-DD72-I-CT-F



1584091

<https://www.phoenixcontact.com/pc/products/1584091>

	DIN VDE 0110-1/04.97
	IEC 60664-1, DIN IEC 60512
	IEC 60352

Testing

Standards/regulations	PC: Fire protection in rail vehicles - requirement sets R22, R23, and R24 acc. to DIN EN 45545-2 (Risk level HL1 - HL3)
-----------------------	---

Contact insert - HC-DD72-I-CT-F



1584091

<https://www.phoenixcontact.com/pc/products/1584091>

Drawings

Diagram

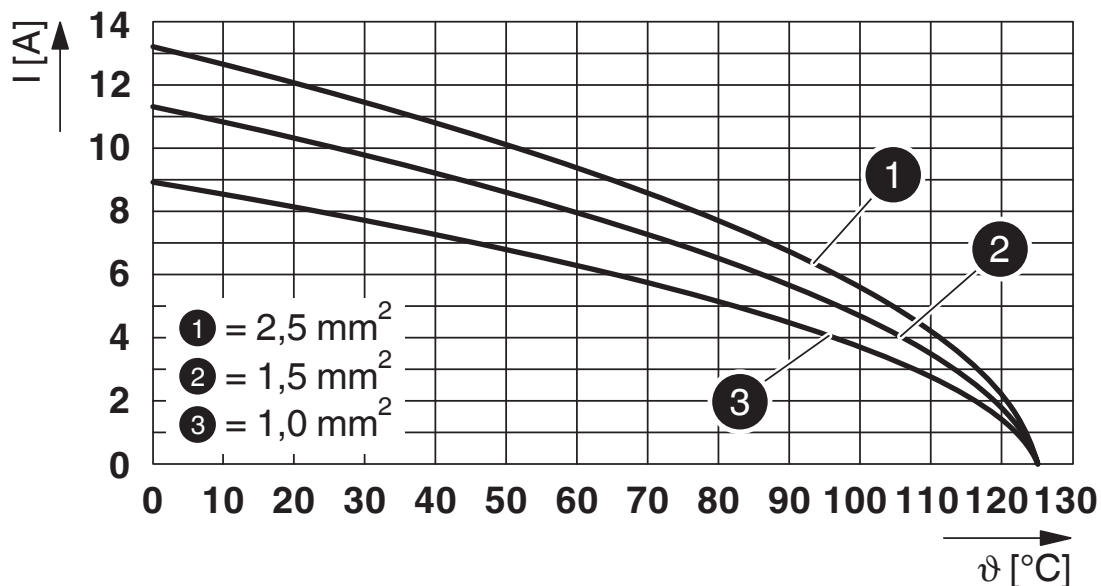

Derating diagram turned contacts

Dimensional drawing

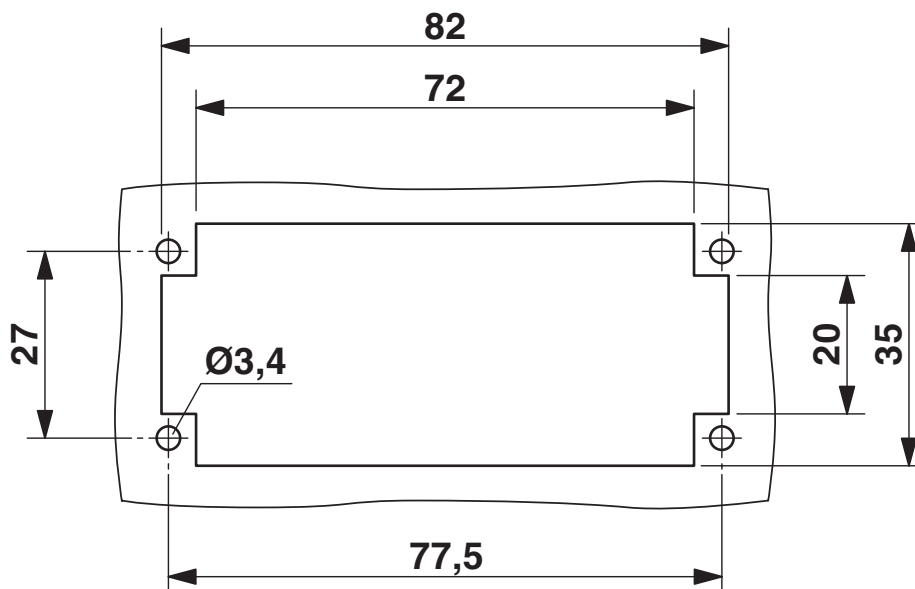

Mounting cutout when used without housing

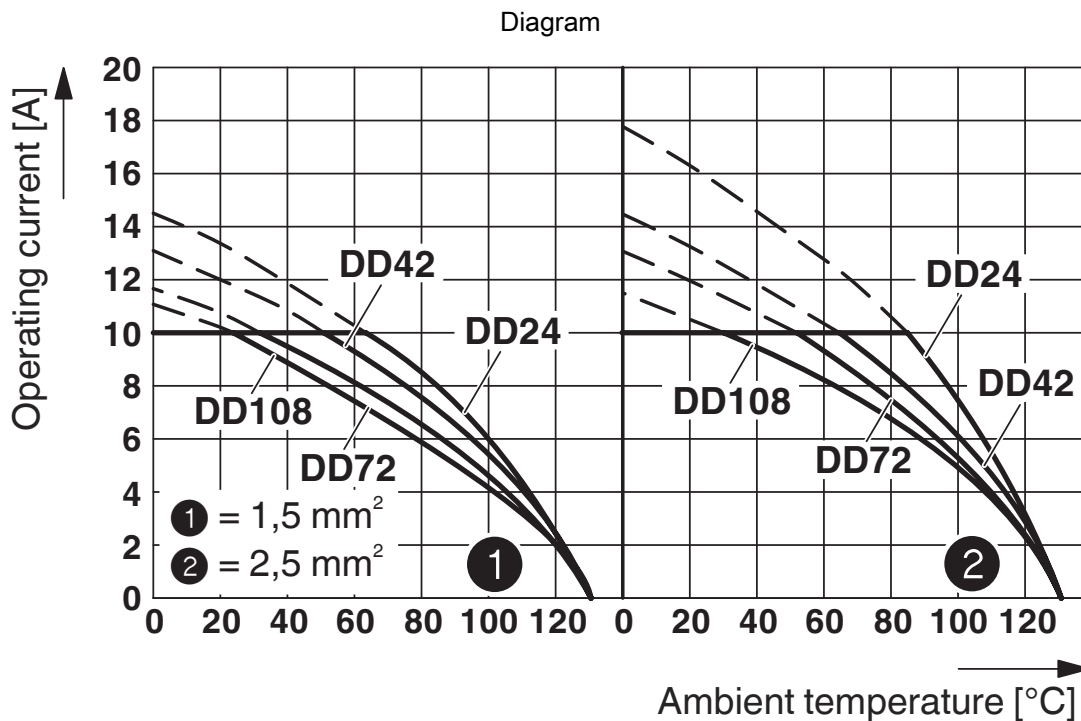

Derating diagram

Contact insert - HC-DD72-I-CT-F

1584091

<https://www.phoenixcontact.com/pc/products/1584091>



Schematic diagram

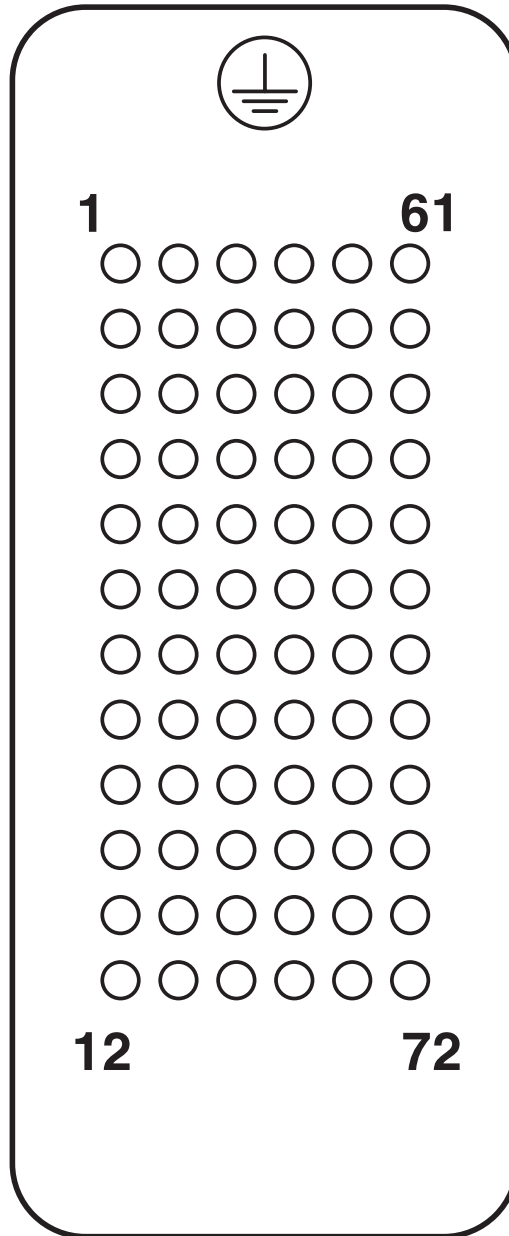

Connector pin assignment, connection side

Contact insert - HC-DD72-I-CT-F



1584091

<https://www.phoenixcontact.com/pc/products/1584091>

Dimensional drawing

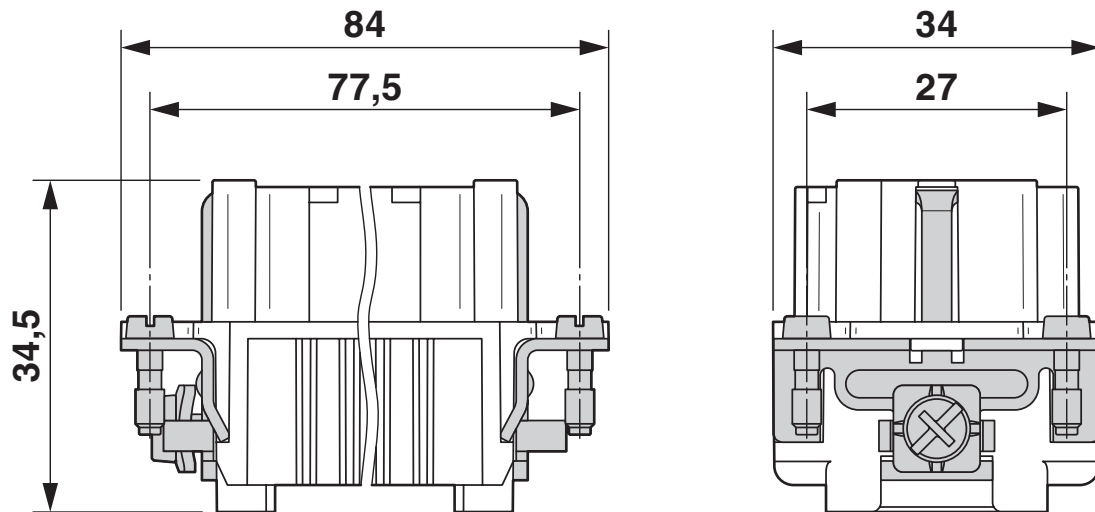

Female insert

Contact insert - HC-DD72-I-CT-F



1584091

<https://www.phoenixcontact.com/pc/products/1584091>

Approvals

DNV

Approval ID: TAE000037S



CSA

Approval ID: 013631_6233_01

	Nominal Voltage U_N	Nominal Current I_N	Cross Section AWG	Cross Section mm^2
	250 V	7 A	26 - 14	-



cUL Recognized

Approval ID: FILE E 118976

	Nominal Voltage U_N	Nominal Current I_N	Cross Section AWG	Cross Section mm^2
	250 V	7 A	- 14	-



UL Recognized

Approval ID: FILE E 118976

	Nominal Voltage U_N	Nominal Current I_N	Cross Section AWG	Cross Section mm^2
	250 V	10 A	- 14	-



EAC

Approval ID: RU C-DE.AI30.B.01102



cULus Recognized

Approval ID: E468743

	Nominal Voltage U_N	Nominal Current I_N	Cross Section AWG	Cross Section mm^2
	250 V	7 A	- 14	-



EAC

Approval ID: RU C-DE.BL08.B.00511

cULus Recognized

Contact insert - HC-DD72-I-CT-F



1584091

<https://www.phoenixcontact.com/pc/products/1584091>

Classifications

ECLASS

ECLASS-9.0	27440205
ECLASS-10.0.1	27440205
ECLASS-11.0	27440205

ETIM

ETIM 8.0	EC000438
----------	----------

UNSPSC

UNSPSC 21.0	39121500
-------------	----------

Contact insert - HC-DD72-I-CT-F



1584091

<https://www.phoenixcontact.com/pc/products/1584091>

Environmental Product Compliance

China RoHS	Environmentally friendly use period: unlimited = EFUP-e
	No hazardous substances above threshold values

Contact insert - HC-DD72-I-CT-F

1584091

<https://www.phoenixcontact.com/pc/products/1584091>

Accessories

Assembly tool

Assembly tool - UNIFOX MT-CK 1.6/2.5 - 1089092

<https://www.phoenixcontact.com/pc/products/1089092>

Assembly tool, for CK 1.6... crimp contacts for small conductor cross sections



Contact insert

Contact insert - HC-DD72-I-CT-M - 1584075

<https://www.phoenixcontact.com/pc/products/1584075>

HEAVYCON male insert, DD72 series, 72-pos., crimp connection



Contact insert - HC-DD72-I-CT-F

1584091

<https://www.phoenixcontact.com/pc/products/1584091>



DIN rail mounting frame

DIN rail mounting frame - HC-CIF-B16-HFWL-PL - 1424336

<https://www.phoenixcontact.com/pc/products/1424336>



DIN rail mounting frame, type: B16, for contact inserts, Top frame

DIN rail mounting frame

DIN rail mounting frame - HC-CIF-B06-24-BFAFL-PL - 1424338

<https://www.phoenixcontact.com/pc/products/1424338>



DIN rail mounting frame, type: B6 - B24, for contact inserts, Base frame

Contact insert - HC-DD72-I-CT-F

1584091

<https://www.phoenixcontact.com/pc/products/1584091>



Front plate

Front plate - HC-DD72-FP-F - 1201498

<https://www.phoenixcontact.com/pc/products/1201498>



Guide element/front plate for the easy and secure connection of HC-DD series high-position connectors. Snap onto the contact insert. During connection, the pin contact is guided into place first, preventing contact with the socket contact.

Adapter

Adapter - HC-B-PE-PT - 1054672

<https://www.phoenixcontact.com/pc/products/1054672>



PE adapter with PT connection, for 1 PE connection, for HC-B / HC-BB / HC-DD / HC-D40 / HC-D64 contact inserts

Contact insert - HC-DD72-I-CT-F

1584091

<https://www.phoenixcontact.com/pc/products/1584091>



Coding element

Coding element - HC-CP-CK1.6-PL - 1095422

<https://www.phoenixcontact.com/pc/products/1095422>

Coding element for HC-D and HC-DD contact inserts with pole loss. Installed in the socket contact chamber.



Coding element

Coding element - HC-CST - 1676857

<https://www.phoenixcontact.com/pc/products/1676857>

Coding peg for coding up to 16 connectors



Contact insert - HC-DD72-I-CT-F

1584091

<https://www.phoenixcontact.com/pc/products/1584091>



Coding element

Coding element - HC-CBU - 1676860

<https://www.phoenixcontact.com/pc/products/1676860>



Coding socket for coding up to 16 connectors

Adapter plate

Adapter plate - HC-B24/16-ADP-SS - 1034216

<https://www.phoenixcontact.com/pc/products/1034216>



Adapter plate, type: B24 to B16

Contact insert - HC-DD72-I-CT-F

1584091

<https://www.phoenixcontact.com/pc/products/1584091>

Strain relief clamp

Strain relief clamp - HC-B-ZG - 1685327

<https://www.phoenixcontact.com/pc/products/1685327>



Strain relief clamps contact inserts of series: B-, BB-, D 40, D 64, DD and HV, straight cable exit

Strain relief clamp

Strain relief clamp - HC-B-ZS - 1685330

<https://www.phoenixcontact.com/pc/products/1685330>



Strain relief clamps contact inserts of series: B-, BB-, D 40, D 64, DD and HV, lateral cable exit

Contact insert - HC-DD72-I-CT-F

1584091

<https://www.phoenixcontact.com/pc/products/1584091>

Screw

Screw - HC-B-PES - 1604997

<https://www.phoenixcontact.com/pc/products/1604997>



PE screw, for contact inserts HC-B / HC-BB / HC-DD / HC-D40 / HC-D64

Female contact

Female contact - CK1,6-ED-BU-POF - 1885004

<https://www.phoenixcontact.com/pc/products/1885004>



POF fiber optic socket contact, turned, for contact carriers (HC-DD...I-CT.../ HC-M-12-CT-F.../ HC-M-17-CT-F...) of CK1,6-ED... contacts

Contact insert - HC-DD72-I-CT-F

1584091

<https://www.phoenixcontact.com/pc/products/1584091>



Contact removal tool

Contact removal tool - UNIFOX RT-CK 1.6 - 1072069

<https://www.phoenixcontact.com/pc/products/1072069>



Contact removal tool, for turned and rolled CK- 1.6-... contacts

Docking frames

Docking frames - HC-B 16-ANDOCK - 1586138

<https://www.phoenixcontact.com/pc/products/1586138>

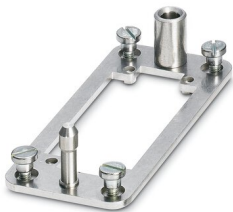

Docking frame for racks, for contact inserts of B16 type, with four M5 flat headed screws, rack balance x/y axis ± 1.5 mm

Contact insert - HC-DD72-I-CT-F

1584091

<https://www.phoenixcontact.com/pc/products/1584091>

Crimp contact

Crimp contact - CK1,6-ED-0,37BU AG - 1663394

<https://www.phoenixcontact.com/pc/products/1663394>



Turned 1.6 crimp contact, individual female contact, core diameter 0.14 to 0.37 mm², silver-plated

Crimp contact

Crimp contact - CK1,6-ED-0,50BU AG - 1663404

<https://www.phoenixcontact.com/pc/products/1663404>



Crimp contact, contact diameter: 1.6 mm, turned, Socket, contact material: Cu alloy, nickel-plated, contact surface: silver-plated, connection cross section: 0.5 mm² ... 0.5 mm², AWG 20

Contact insert - HC-DD72-I-CT-F

1584091

<https://www.phoenixcontact.com/pc/products/1584091>

Crimp contact

Crimp contact - CK1,6-ED-0,75BU AG - 1663417

<https://www.phoenixcontact.com/pc/products/1663417>



Crimp contact, contact diameter: 1.6 mm, turned, Socket, contact material: Copper alloy, contact surface: silver-plated, connection cross section: 0.75 mm² ... 0.75 mm², AWG 18

Crimp contact

Crimp contact - CK1,6-ED-1,00BU AG - 1663420

<https://www.phoenixcontact.com/pc/products/1663420>



Crimp contact, contact diameter: 1.6 mm, turned, Socket, contact material: Copper alloy, contact surface: silver-plated, connection cross section: 1 mm² ... 1 mm², AWG 18

Contact insert - HC-DD72-I-CT-F

1584091

<https://www.phoenixcontact.com/pc/products/1584091>

Crimp contact

Crimp contact - CK1,6-ED-1,50BU AG - 1663433

<https://www.phoenixcontact.com/pc/products/1663433>



Turned 1.6 crimp contact, individual female contact, core diameter 1.5 mm², silver-plated

Crimp contact

Crimp contact - CK1,6-ED-2,50BU AG - 1663446

<https://www.phoenixcontact.com/pc/products/1663446>



Turned 1.6 crimp contact, individual female contact, core diameter 2.5 mm², gold-plated

Contact insert - HC-DD72-I-CT-F

1584091

<https://www.phoenixcontact.com/pc/products/1584091>



Crimp contact

Crimp contact - CK1,6-ED-0,37BU AU - 1674969

<https://www.phoenixcontact.com/pc/products/1674969>



Crimp contact, contact diameter: 1.6 mm, turned, Socket, contact material: Copper alloy, contact surface: gold-plated, connection cross section: 0.14 mm² ... 0.37 mm², AWG 24 ... 22

Crimp contact

Crimp contact - CK1,6-ED-0,50BU AU - 1674480

<https://www.phoenixcontact.com/pc/products/1674480>



Crimp contact, contact diameter: 1.6 mm, turned, Socket, contact material: Copper alloy, contact surface: gold-plated, connection cross section: 0.5 mm² ... 0.5 mm², AWG 20

Contact insert - HC-DD72-I-CT-F

1584091

<https://www.phoenixcontact.com/pc/products/1584091>



Crimp contact

Crimp contact - CK1,6-ED-0,75BU AU - 1672440

<https://www.phoenixcontact.com/pc/products/1672440>



Crimp contact, contact diameter: 1.6 mm, turned, Socket, contact material: Copper alloy, contact surface: gold-plated, connection cross section: 0.75 mm² ... 0.75 mm², AWG 18

Crimp contact

Crimp contact - CK1,6-ED-1,00BU AU - 1674943

<https://www.phoenixcontact.com/pc/products/1674943>



Crimp contact, contact diameter: 1.6 mm, turned, Socket, contact material: Copper alloy, contact surface: gold-plated, connection cross section: 1 mm² ... 1 mm², AWG 18

Contact insert - HC-DD72-I-CT-F

1584091

<https://www.phoenixcontact.com/pc/products/1584091>



Crimp contact

Crimp contact - CK1,6-ED-1,50BU AU - 1674930

<https://www.phoenixcontact.com/pc/products/1674930>



Turned 1.6 crimp contact, individual female contact, core diameter 1.5 mm², silver-plated

Crimp contact

Crimp contact - CK1,6-ED-2,50BU AU - 1674985

<https://www.phoenixcontact.com/pc/products/1674985>



Turned 1.6 crimp contact, individual female contact, core diameter 2.5 mm², gold-plated

Contact insert - HC-DD72-I-CT-F

1584091

<https://www.phoenixcontact.com/pc/products/1584091>

Crimp contact

Crimp contact - CK1,6-ER-1,00BU OIC AG - 1004362

<https://www.phoenixcontact.com/pc/products/1004362>



Crimp contact, contact diameter: 1.6 mm, rolled, Socket, contact material: Cu alloy, nickel-plated, contact surface: silver-plated, connection cross section: 0.34 mm² ... 1 mm², AWG 22 ... 17

Crimp contact

Crimp contact - CK1,6-ER-2,50BU OIC AG - 1004366

<https://www.phoenixcontact.com/pc/products/1004366>



Crimp contact, contact diameter: 1.6 mm, rolled, Socket, contact material: Cu alloy, nickel-plated, contact surface: silver-plated, connection cross section: 1.5 mm² ... 2.5 mm², AWG 16 ... 14

Contact insert - HC-DD72-I-CT-F

1584091

<https://www.phoenixcontact.com/pc/products/1584091>

Crimp contact

Crimp contact - CK1,6-BR-1,00BU OIC AG - 1004381

<https://www.phoenixcontact.com/pc/products/1004381>



Crimp contact, contact diameter: 1.6 mm, rolled, Socket, contact material: Cu alloy, nickel-plated, contact surface: silver-plated, connection cross section: 0.34 mm² ... 1 mm², AWG 22 ... 17, Taped products

Crimp contact

Crimp contact - CK1,6-BR-2,50BU OIC AG - 1004383

<https://www.phoenixcontact.com/pc/products/1004383>



Crimp contact, contact diameter: 1.6 mm, rolled, Socket, contact material: Cu alloy, nickel-plated, contact surface: silver-plated, connection cross section: 1.5 mm² ... 2.5 mm², AWG 16 ... 14, Taped products

Contact insert - HC-DD72-I-CT-F

1584091

<https://www.phoenixcontact.com/pc/products/1584091>

Crimping pliers

Crimping pliers - CRIMPFOX-1,6/2,5-ED-4,0 - 1687419

<https://www.phoenixcontact.com/pc/products/1687419>



Crimping pliers, for turned contacts, CK 1.6 ED... and CK 2.5 ED...

Crimping pliers

Crimping pliers - CRIMPFOX-TC 4 - 1212113

<https://www.phoenixcontact.com/pc/products/1212113>



Crimping pliers, for CK 1,6-ED..., CK 2,5-ED..., CK 4,0-ED... turned contacts, 4 marked die stations, unlockable pressure lock, lateral entry, incl. positioning tool

Contact insert - HC-DD72-I-CT-F

1584091

<https://www.phoenixcontact.com/pc/products/1584091>



Crimping pliers with digital display

Crimping pliers with digital display - CRIMPFOX-TC MP-6 - 1202888

<https://www.phoenixcontact.com/pc/products/1202888>



Crimping tool, for turned contacts, universal cross-section setting, up to a maximum of 6.0 mm², digital display with 0.01 mm increments, pressure lock can be unlocked, positioning tool necessary as an accessory for contact positioning

PE multiplier

PE multiplier - HC-B-2PE-PT - 1054675

<https://www.phoenixcontact.com/pc/products/1054675>

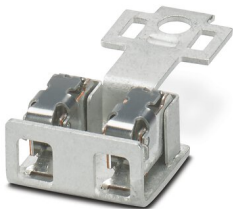

PE adapter with PT connection, for 2 PE connections, for HC-B / HC-BB / HC-DD / HC-D40 / HC-D64 contact inserts

Contact insert - HC-DD72-I-CT-F

1584091

<https://www.phoenixcontact.com/pc/products/1584091>



PE multiplier

PE multiplier - HC-B-3PE - 1644326

<https://www.phoenixcontact.com/pc/products/1644326>

PE multiplier, for 3 PE connections, for HC-B / HC-BB / HC-DD / HC-D40 / HC-D64 contact inserts



Phoenix Contact 2022 © - all rights reserved

<https://www.phoenixcontact.com>

PHOENIX CONTACT GmbH & Co. KG

Flachsmarktstraße 8

D-32825 Blomberg

+49 (0) 5235-3 00

info@phoenixcontact.com