

Screwdriver - SZF 0-0,4X2,5

1204504

<https://www.phoenixcontact.com/de/produkte/1204504>



Please be informed that the data shown in this PDF document is generated from our Online Catalog. Please find the complete data in the user documentation. Our General Terms of Use for Downloads are valid.



Actuation tool, for ST terminal blocks, also suitable for use as a bladed screwdriver, size: 0.4 x 2.5 x 75 mm, 2-component grip, with non-slip grip

Your advantages

- In addition to its standard application, this screwdriver is also ideal for actuating ST ... and QTC ... modular terminal blocks

Screwdriver - SZF 0-0,4X2,5



1204504

<https://www.phoenixcontact.com/de/produkte/1204504>

Commercial Data

Item number	1204504
Packing unit	10 pc
Minimum order quantity	1 pc
Sales Key	N2 - Druck.Zubh.+HandWKZ
Product Key	BH3141
Catalog Page	Page 448 (C-3-2019)
GTIN	4017918018931
Weight per Piece (including packing)	30,02 g
Weight per Piece (excluding packing)	28 g
Customs tariff number	82054000
Country of origin	CZ

Screwdriver - SZF 0-0,4X2,5

1204504

<https://www.phoenixcontact.com/de/produkte/1204504>



Technical Data

Notes

Environmental Product Compliance

California Proposition 65

Further information on California's prop. 65 is available under "Downloads" in the manufacturer's declaration

Product properties

Type

Bladed

Product type

Screwdriver tools

Connection data

Output

Bladed

Dimensions

Dimensional drawing

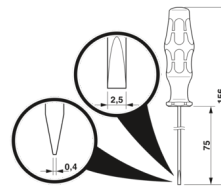

Width

26 mm

Blade width

2.5 mm

Blade height

75 mm

Length

156 mm

Wrench size

0 mm

Blade thickness

0.4 mm

Material specifications

Material

alloyed tool steel

Standards and regulations

Tests

DIN/ISO 2380-1

Mounting

Wrench size

0 mm

Screwdriver - SZF 0-0,4X2,5

1204504

<https://www.phoenixcontact.com/de/produkte/1204504>



Drawings

Dimensional drawing

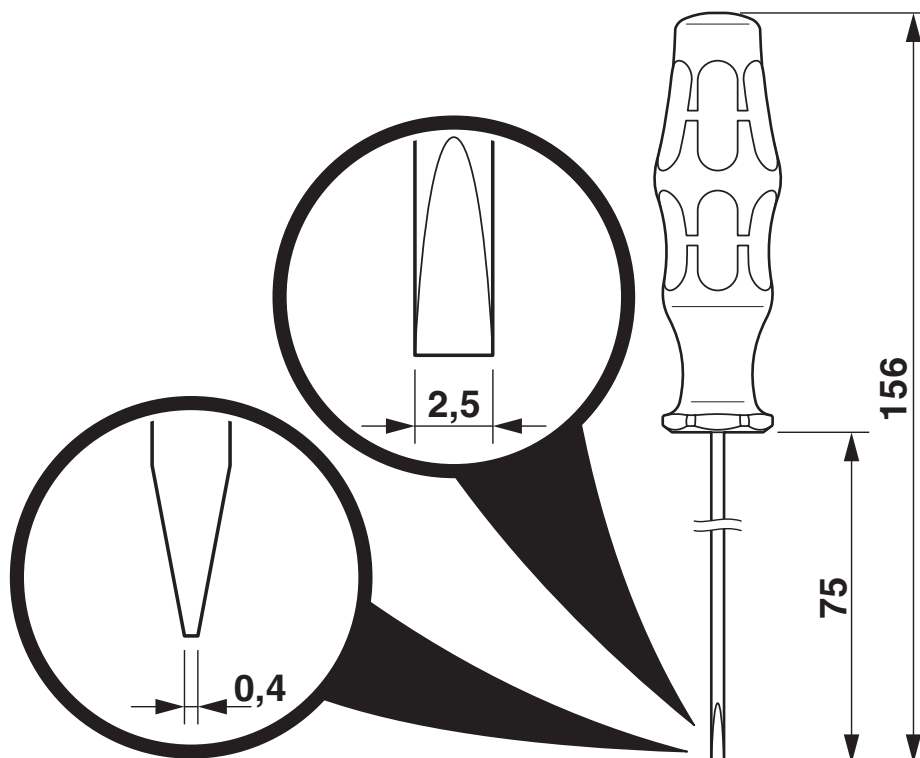

Screwdriver - SZF 0-0,4X2,5

1204504

<https://www.phoenixcontact.com/de/produkte/1204504>



Approvals



EAC

Approval ID: RU x-DE.xx08.B.02974

Screwdriver - SZF 0-0,4X2,5



1204504

<https://www.phoenixcontact.com/de/produkte/1204504>

Classifications

ECLASS

ECLASS-9.0	21040407
ECLASS-10.0.1	21040407
ECLASS-11.0	21040407

ETIM

ETIM 8.0	EC000158
----------	----------

UNSPSC

UNSPSC 21.0	27111700
-------------	----------

Phoenix Contact 2022 © - all rights reserved

<https://www.phoenixcontact.com>

PHOENIX CONTACT Deutschland GmbH

Flachmarktstraße 8

D-32825 Blomberg

+49 52 35/3-1 20 00

info@phoenixcontact.de