

DIN rail connector - UMSTBVK 2,5/10-G-5,08

1788198

<https://www.phoenixcontact.com/de/produkte/1788198>

Please be informed that the data shown in this PDF document is generated from our Online Catalog. Please find the complete data in the user documentation. Our General Terms of Use for Downloads are valid.



DIN rail connector, nominal cross section: 2.5 mm², color: green, nominal current: 12 A, rated voltage (III/2): 320 V, contact surface: Tin, type of contact: Male connector, number of potentials: 10, number of rows: 1, number of positions: 10, number of connections: 10, product range: UMSTBVK 2,5/...-G, pitch: 5.08 mm, connection method: Screw connection with tension sleeve, screw head form: L Slotted, conductor/PCB connection direction: 0 °, number of solder pins per potential: 1, plug-in system: COMBICON MSTB 2,5, locking: without, mounting: without, type of packaging: packed in cardboard

Your advantages

- Direct plug-in block with universal foot for mounting on NS 32 or NS 35 DIN rail
- Can be combined with the MSTB 2,5 range
- Well-known connection principle allows worldwide use

DIN rail connector - UMSTBVK 2,5/10-G-5,08



1788198

<https://www.phoenixcontact.com/de/produkte/1788198>

Commercial Data

Item number	1788198
Packing unit	50 pc
Minimum order quantity	50 pc
Sales Key	E1 - Leiterplattenanschl.
Product Key	AACMFC
Catalog Page	Page 361 (C-1-2013)
GTIN	4017918043254
Weight per Piece (including packing)	31,48 g
Weight per Piece (excluding packing)	29,936 g
Customs tariff number	85366990
Country of origin	DE

Technical Data

Product properties

Type	DIN rail mounting
Product line	COMBICON Connectors M
Product type	DIN rail connector
Number of positions	10
Pitch	5.08 mm
Number of connections	10
Number of rows	1
Mounting flange	without
Number of potentials	10

Electrical properties

Nominal current I_N	12 A
Nominal voltage U_N	320 V
Pollution degree	3
Rated voltage (III/3)	320 V
Rated surge voltage (III/3)	4 kV
Rated voltage (III/2)	320 V
Rated surge voltage (III/2)	4 kV

Connection data

Connection technology

Type	DIN rail mounting
Connector system	COMBICON MSTB 2,5
Nominal cross section	2.5 mm ²
Type of contact	Male connector

Interlock

Locking type	without
Mounting flange	without

Conductor connection

Connection method	Screw connection with tension sleeve
Connection direction of the conductor to plug-in direction	0 °
Conductor cross section solid	0.2 mm ² ... 2.5 mm ²
Conductor cross section flexible	0.2 mm ² ... 2.5 mm ²
Conductor cross section AWG	24 ... 12
Conductor cross section flexible, with ferrule without plastic sleeve	0.25 mm ² ... 2.5 mm ²
Conductor cross section, flexible, with ferrule, with plastic sleeve	0.25 mm ² ... 2.5 mm ²
2 conductors with same cross section, solid	0.2 mm ² ... 1 mm ²
2 conductors with same cross section, flexible	0.2 mm ² ... 1.5 mm ²

DIN rail connector - UMSTBVK 2,5/10-G-5,08

1788198

<https://www.phoenixcontact.com/de/produkte/1788198>

2 conductors with same cross section, flexible, with ferrule without plastic sleeve	0.25 mm ² ... 1 mm ²
2 conductors with the same cross section, flexible, with TWIN ferrule with plastic sleeve	0.5 mm ² ... 1.5 mm ²
Stripping length	7 mm
Torque	0.5 Nm ... 0.6 Nm

Mounting

Mounting type DIN rail	DIN rail
Mounting type	DIN rail
Drive form screw head	Slotted (L)

Material specifications

Material data - contact

Note	WEEE/RoHS-compliant, free of whiskers according to IEC 60068-2-82/JEDEC JESD 201
Contact material	Cu alloy
Surface characteristics	Tin-plated
Metal surface terminal point (top layer)	Tin (5 - 7 µm Sn)
Metal surface terminal point (middle layer)	Nickel (2 - 3 µm Ni)
Metal surface contact area (top layer)	Tin (5 - 7 µm Sn)
Metal surface contact area (middle layer)	Nickel (2 - 3 µm Ni)

Material data - housing

Housing color	green (6021)
Insulating material	PA
Insulating material group	I
CTI according to IEC 60112	600
Flammability rating according to UL 94	V0
Glow wire flammability index GWFI according to EN 60695-2-12	850
Glow wire ignition temperature GWIT according to EN 60695-2-13	775
Temperature for the ball pressure test according to EN 60695-10-2	125 °C

Notes

Notes on operation	In accordance with IEC 61984, COMBICON connectors have no switching power (COC). During designated use, they must not be plugged in or disconnected when carrying voltage or under load.
--------------------	--

Dimensions

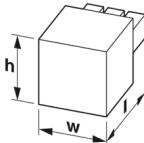
Dimensional drawing	
---------------------	--

DIN rail connector - UMSTBVK 2,5/10-G-5,08



1788198

<https://www.phoenixcontact.com/de/produkte/1788198>

Pitch	5.08 mm
Width [w]	52.3 mm
Height [h]	34.5 mm
Length [l]	42.52 mm

Electrical tests

Air clearances and creepage distances |

Specification	IEC 60664-1:2007-04
Insulating material group	I
Comparative tracking index (IEC 60112)	CTI 600
Rated insulation voltage (III/3)	320 V
Rated surge voltage (III/3)	4 kV
minimum clearance value - non-homogenous field (III/3)	3 mm
minimum creepage distance (III/3)	4 mm
Rated insulation voltage (III/2)	320 V
Rated surge voltage (III/2)	4 kV
minimum clearance value - non-homogenous field (III/2)	3 mm
minimum creepage distance (III/2)	3 mm
Rated insulation voltage (II/2)	630 V
Rated surge voltage (II/2)	4 kV
minimum clearance value - non-homogenous field (II/2)	3 mm
minimum creepage distance (II/2)	3.2 mm

Environmental and real-life conditions

Ambient conditions

Ambient temperature (operation)	-40 °C ... 100 °C (dependent on the derating curve)
Ambient temperature (storage/transport)	-40 °C ... 70 °C
Relative humidity (storage/transport)	30 % ... 70 %
Ambient temperature (assembly)	-5 °C ... 100 °C

Packaging specifications

Type of packaging	packed in cardboard
-------------------	---------------------

DIN rail connector - UMSTBVK 2,5/10-G-5,08

1788198

<https://www.phoenixcontact.com/de/produkte/1788198>



Drawings

Dimensional drawing

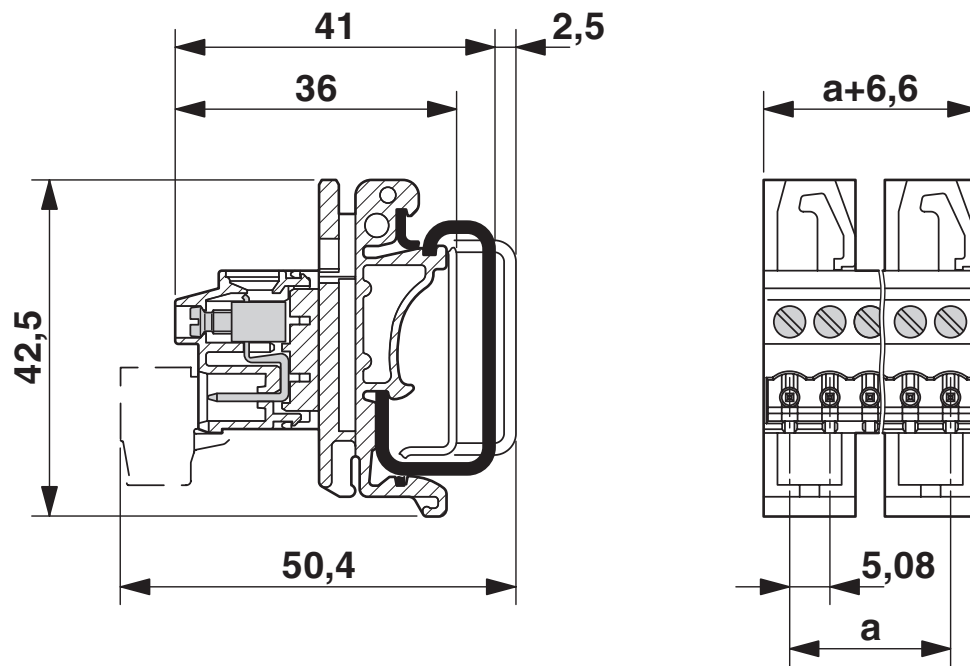

DIN rail connector - UMSTBVK 2,5/10-G-5,08



1788198

<https://www.phoenixcontact.com/de/produkte/1788198>

Approvals

 CSA Approval ID: 13631				
	Nominal Voltage U_N	Nominal Current I_N	Cross Section AWG	Cross Section mm^2
Use group B	300 V	10 A	28 - 12	-
Use group D	300 V	10 A	28 - 12	-

 IECEE CB Scheme Approval ID: DE1-60988-B1B2				
	Nominal Voltage U_N	Nominal Current I_N	Cross Section AWG	Cross Section mm^2
	250 V	12 A	-	0.2 - 2.5

 EAC Approval ID: B.01687				
--	--	--	--	--

 cULus Recognized Approval ID: E60425-19931014				
	Nominal Voltage U_N	Nominal Current I_N	Cross Section AWG	Cross Section mm^2
Use group B	250 V	12 A	30 - 12	-
Use group D	300 V	10 A	30 - 12	-

 VDE Zeichengenehmigung Approval ID: 40050694				
	Nominal Voltage U_N	Nominal Current I_N	Cross Section AWG	Cross Section mm^2
	250 V	12 A	-	0.2 - 2.5

DIN rail connector - UMSTBVK 2,5/10-G-5,08



1788198

<https://www.phoenixcontact.com/de/produkte/1788198>

Classifications

ECLASS

ECLASS-9.0	27141106
ECLASS-10.0.1	27141106
ECLASS-11.0	27141106

ETIM

ETIM 8.0	EC001284
----------	----------

UNSPSC

UNSPSC 21.0	39121400
-------------	----------

DIN rail connector - UMSTBVK 2,5/10-G-5,08



1788198

<https://www.phoenixcontact.com/de/produkte/1788198>

Environmental Product Compliance

REACH SVHC	Lead 7439-92-1
China RoHS	Environmentally Friendly Use Period = 50 years
	For information on hazardous substances, refer to the manufacturer's declaration available under "Downloads"

DIN rail connector - UMSTBVK 2,5/10-G-5,08



1788198

<https://www.phoenixcontact.com/de/produkte/1788198>

Accessories

Marker card

Marker card - SK 5,08/3,8:FORTL.ZAHLEN - 0804293

<https://www.phoenixcontact.com/de/produkte/0804293>



Marker card, white, labeled, horizontal: consecutive numbers 1 ... 10, 11 ... 20, etc. up to 91 ... (99)100, mounting type: adhesive, for terminal block width: 5.08 mm, lettering field size: 5.08 x 3.8 mm

Coding section

Coding section - CR-MSTB - 1734401

<https://www.phoenixcontact.com/de/produkte/1734401>



Coding section, inserted into the recess in the header or the inverted plug, red insulating material

DIN rail connector - UMSTBVK 2,5/10-G-5,08

1788198

<https://www.phoenixcontact.com/de/produkte/1788198>

Accessories

Accessories - MSTB-BL - 1755477

<https://www.phoenixcontact.com/de/produkte/1755477>



Keying cap, for forming sections, plugs onto header pin, green insulating material

Screwdriver

Screwdriver - SZS 0,6X3,5 - 1205053

<https://www.phoenixcontact.com/de/produkte/1205053>



Actuation tool, for ST terminal blocks, insulated, also suitable for use as a bladed screwdriver, size: 0.6 x 3.5 x 100 mm, 2-component grip, with non-slip grip

DIN rail connector - UMSTBVK 2,5/10-G-5,08

1788198

<https://www.phoenixcontact.com/de/produkte/1788198>

Insertion bridge

Insertion bridge - EBP 2- 5 - 1733169

<https://www.phoenixcontact.com/de/produkte/1733169>

Insertion bridge for connectors with 5.0 mm or 5.08 mm pitch



PCB connector

PCB connector - MSTB 2,5/10-ST-5,08 - 1757093

<https://www.phoenixcontact.com/de/produkte/1757093>



PCB connector, nominal cross section: 2.5 mm², color: green, nominal current: 12 A, rated voltage (III/2): 320 V, contact surface: Tin, type of contact: Female connector, number of potentials: 10, number of rows: 1, number of positions: 10, number of connections: 10, product range: MSTB 2,5/..-ST, pitch: 5.08 mm, connection method: Screw connection with tension sleeve, screw head form: L Slotted, conductor/PCB connection direction: 0 °, locking clip: - Locking clip, plug-in system: COMBICON MSTB 2,5, locking: without, mounting: without, type of packaging: packed in cardboard

DIN rail connector - UMSTBVK 2,5/10-G-5,08

1788198

<https://www.phoenixcontact.com/de/produkte/1788198>

PCB connector

PCB connector - MSTB 2,5/10-STZ-5,08 - 1764303

<https://www.phoenixcontact.com/de/produkte/1764303>



PCB connector, nominal cross section: 2.5 mm², color: green, nominal current: 12 A, rated voltage (III/2): 320 V, contact surface: Tin, type of contact: Female connector, number of potentials: 10, number of rows: 1, number of positions: 10, number of connections: 10, product range: MSTB 2,5/...-STZ, pitch: 5.08 mm, connection method: Screw connection with tension sleeve, screw head form: L Slotted, conductor/PCB connection direction: 0 °, locking clip: - Locking clip, plug-in system: COMBICON MSTB 2,5, locking: without, mounting: without, type of packaging: packed in cardboard

PCB connector

PCB connector - MSTBP 2,5/10-ST-5,08 - 1769094

<https://www.phoenixcontact.com/de/produkte/1769094>

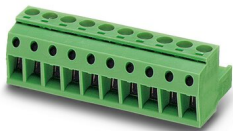

PCB connector, nominal cross section: 2.5 mm², color: green, nominal current: 12 A, rated voltage (III/2): 320 V, contact surface: Tin, type of contact: Female connector, number of potentials: 10, number of rows: 1, number of positions: 10, number of connections: 10, product range: MSTBP 2,5/...-ST, pitch: 5.08 mm, connection method: Screw connection with tension sleeve, screw head form: L Slotted, conductor/PCB connection direction: 0 °, locking clip: - Locking clip, plug-in system: COMBICON MSTB 2,5, locking: without, mounting: without, type of packaging: packed in cardboard

DIN rail connector - UMSTBVK 2,5/10-G-5,08

1788198

<https://www.phoenixcontact.com/de/produkte/1788198>

PCB connector

PCB connector - SMSTB 2,5/10-ST-5,08 - 1826364

<https://www.phoenixcontact.com/de/produkte/1826364>



PCB connector, nominal cross section: 2.5 mm², color: green, nominal current: 12 A, rated voltage (III/2): 320 V, contact surface: Tin, type of contact: Female connector, number of potentials: 10, number of rows: 1, number of positions: 10, number of connections: 10, product range: SMSTB 2,5/..-ST, pitch: 5.08 mm, connection method: Screw connection with tension sleeve, screw head form: L Slotted, conductor/PCB connection direction: -45 °, locking clip: - Locking clip, plug-in system: COMBICON MSTB 2,5, locking: without, mounting: without, type of packaging: packed in cardboard

PCB connector

PCB connector - MVSTBR 2,5/10-ST-5,08 - 1792320

<https://www.phoenixcontact.com/de/produkte/1792320>

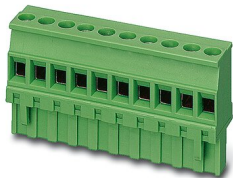

PCB connector, nominal cross section: 2.5 mm², color: green, nominal current: 12 A, rated voltage (III/2): 320 V, contact surface: Tin, type of contact: Female connector, number of potentials: 10, number of rows: 1, number of positions: 10, number of connections: 10, product range: MVSTBR 2,5/..-ST, pitch: 5.08 mm, connection method: Screw connection with tension sleeve, screw head form: L Slotted, conductor/PCB connection direction: 90 °, locking clip: - Locking clip, plug-in system: COMBICON MSTB 2,5, locking: without, mounting: without, type of packaging: packed in cardboard

DIN rail connector - UMSTBVK 2,5/10-G-5,08

1788198

<https://www.phoenixcontact.com/de/produkte/1788198>

PCB connector

PCB connector - MVSTBW 2,5/10-ST-5,08 - 1792838

<https://www.phoenixcontact.com/de/produkte/1792838>

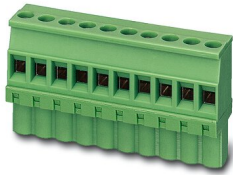

PCB connector, nominal cross section: 2.5 mm², color: green, nominal current: 12 A, rated voltage (III/2): 320 V, contact surface: Tin, type of contact: Female connector, number of potentials: 10, number of rows: 1, number of positions: 10, number of connections: 10, product range: MVSTBW 2,5/...-ST, pitch: 5.08 mm, connection method: Screw connection with tension sleeve, screw head form: L Slotted, conductor/PCB connection direction: -90 °, locking clip: - Locking clip, plug-in system: COMBICON MSTB 2,5, locking: without, mounting: without, type of packaging: packed in cardboard

PCB connector

PCB connector - FRONT-MSTB 2,5/10-ST-5,08 - 1777361

<https://www.phoenixcontact.com/de/produkte/1777361>



PCB connector, nominal cross section: 2.5 mm², color: green, nominal current: 12 A, rated voltage (III/2): 320 V, contact surface: Tin, type of contact: Female connector, number of potentials: 10, number of rows: 1, number of positions: 10, number of connections: 10, product range: FRONT-MSTB 2,5/...-ST, pitch: 5.08 mm, connection method: Front screw connection, screw head form: L Slotted, conductor/PCB connection direction: 0 °, locking clip: - Locking clip, plug-in system: COMBICON MSTB 2,5, locking: without, mounting: without, type of packaging: packed in cardboard

DIN rail connector - UMSTBVK 2,5/10-G-5,08

1788198

<https://www.phoenixcontact.com/de/produkte/1788198>

PCB connector

PCB connector - FKC 2,5/10-ST-5,08 - 1873139

<https://www.phoenixcontact.com/de/produkte/1873139>

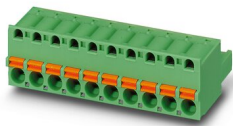

PCB connector, nominal cross section: 2.5 mm², color: green, nominal current: 12 A, rated voltage (III/2): 320 V, contact surface: Tin, type of contact: Female connector, number of potentials: 10, number of rows: 1, number of positions: 10, number of connections: 10, product range: FKC 2,5/...-ST, pitch: 5.08 mm, connection method: Push-in spring connection, conductor/PCB connection direction: 0 °, locking clip: - Locking clip, plug-in system: COMBICON MSTB 2,5, locking: without, mounting: without, type of packaging: packed in cardboard

PCB connector

PCB connector - FKCVR 2,5/10-ST-5,08 - 1874031

<https://www.phoenixcontact.com/de/produkte/1874031>

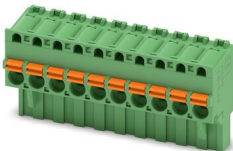

PCB connector, nominal cross section: 2.5 mm², color: green, nominal current: 12 A, rated voltage (III/2): 320 V, contact surface: Tin, type of contact: Female connector, number of potentials: 10, number of rows: 1, number of positions: 10, number of connections: 10, product range: FKCVR 2,5/...-ST, pitch: 5.08 mm, connection method: Push-in spring connection, conductor/PCB connection direction: 90 °, locking clip: - Locking clip, plug-in system: COMBICON MSTB 2,5, locking: without, mounting: without, type of packaging: packed in cardboard

DIN rail connector - UMSTBVK 2,5/10-G-5,08

1788198

<https://www.phoenixcontact.com/de/produkte/1788198>

PCB connector

PCB connector - QC 1/10-ST-5,08 - 1883336

<https://www.phoenixcontact.com/de/produkte/1883336>

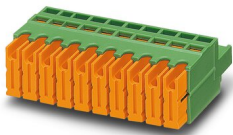

PCB connector, nominal cross section: 1 mm², color: green, nominal current: 10 A, rated voltage (III/2): 630 V, contact surface: Tin, type of contact: Female connector, number of potentials: 10, number of rows: 1, number of positions: 10, number of connections: 10, product range: QC 1/..-ST, pitch: 5.08 mm, connection method: Displacement connection, conductor/PCB connection direction: 0 °, locking clip: - Locking clip, plug-in system: COMBICON MSTB 2,5, locking: without, mounting: without, type of packaging: packed in cardboard

PCB connector

PCB connector - MSTBC 2,5/10-ST-5,08 - 1808890

<https://www.phoenixcontact.com/de/produkte/1808890>



PCB connector, nominal cross section: 2.5 mm², color: green, nominal current: 12 A, rated voltage (III/2): 320 V, type of contact: Female connector, number of potentials: 10, number of rows: 1, number of positions: 10, number of connections: 10, product range: MSTBC 2,5/..-ST, pitch: 5.08 mm, connection method: Crimp connection, conductor/PCB connection direction: 0 °, locking clip: - Locking clip, plug-in system: COMBICON MSTB 2,5, locking: without, mounting: without, type of packaging: packed in cardboard, Corresponding female crimp contacts with current [A] and conductor cross section range [mm²] data: 10A/MSTBC-MT 0,5-1,0 (3190564); 10A/MSTBC-MT 0,5-1,0 BA (3190645); 12A/MSTBC-MT 1,5-2,5 (3190551); 12A/MSTBC-MT 1,5-2,5 BA (3190658). BA = Bandkontakte

DIN rail connector - UMSTBVK 2,5/10-G-5,08



1788198

<https://www.phoenixcontact.com/de/produkte/1788198>

PCB connector

PCB connector - MSTBC 2,5/10-STZ-5,08 - 1809585

<https://www.phoenixcontact.com/de/produkte/1809585>



PCB connector, nominal cross section: 2.5 mm², color: green, nominal current: 12 A, rated voltage (III/2): 320 V, type of contact: Female connector, number of potentials: 10, number of rows: 1, number of positions: 10, number of connections: 10, product range: MSTBC 2,5/...-STZ, pitch: 5.08 mm, connection method: Crimp connection, conductor/PCB connection direction: 0 °, locking clip: - Locking clip, plug-in system: COMBICON MSTB 2,5, locking: without, mounting: without, type of packaging: packed in cardboard, Corresponding female crimp contacts with current [A] and conductor cross section range [mm²] data: 10A/MSTBC-MT 0,5-1,0 (3190564); 10A/MSTBC-MT 0,5-1,0 BA (3190645); 12A/MSTBC-MT 1,5-2,5 (3190551); 12A/MSTBC-MT 1,5-2,5 BA (3190658). BA = Bandkontakte

Phoenix Contact 2022 © - all rights reserved
<https://www.phoenixcontact.com>

PHOENIX CONTACT Deutschland GmbH
Flachmarktstraße 8
D-32825 Blomberg
+49 52 35/3-1 20 00
info@phoenixcontact.de