

Single relay - REL-MR-110DC/21-21



2961202

<https://www.phoenixcontact.com/de/produkte/2961202>

Please be informed that the data shown in this PDF document is generated from our Online Catalog. Please find the complete data in the user documentation. Our General Terms of Use for Downloads are valid.

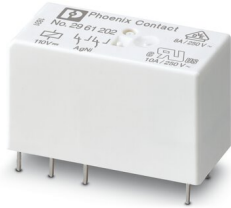

Plug-in miniature power relay, with power contact, 2 changeover contacts, input voltage 110 V DC

Your advantages

- RT III-proof (wash-proof)
- Switching current of up to 8 A

Single relay - REL-MR-110DC/21-21



2961202

<https://www.phoenixcontact.com/de/produkte/2961202>

Commercial Data

Item number	2961202
Packing unit	10 pc
Minimum order quantity	10 pc
Sales Key	G1 - Relais
Product Key	CK6195
Catalog Page	Page 290 (C-5-2019)
GTIN	4017918158002
Weight per Piece (including packing)	17 g
Weight per Piece (excluding packing)	16,125 g
Customs tariff number	85364900
Country of origin	AT

Single relay - REL-MR-110DC/21-21



2961202

<https://www.phoenixcontact.com/de/produkte/2961202>

Technical Data

Product properties

Product type	Single relay
Set comprises	2967086 PLC-RSC-120UC/21-21
	2967099 PLC-RSC-230UC/21-21
	2912549 PLC-RSP-120UC/21-21
	2912552 PLC-RSP-230UC/21-21
	2900335 PLC-RPT-120UC/21-21
	2900336 PLC-RPT-230UC/21-21
Operating mode	100% operating factor
Mechanical service life	3x 10 ⁷ cycles

Insulation characteristics

Overvoltage category	III
Pollution degree	3
Insulation	Basic insulation

Electrical properties

Service life electrical	see diagram
Maximum power dissipation for nominal condition	0.45 W
Test voltage	5 kV AC (50 Hz, 1 min., winding/contact)
Test voltage Contact/contact	2.5 kV AC (50 Hz, 1 min., contact/contact)

Input data

Coil side

Nominal input voltage U_N	110 V DC
Input voltage range	71.5 V DC ... 272.8 V DC
Typical input current at U_N	4.1 mA
Typical response time	7 ms
Typical release time	3 ms
Coil resistance	26600 Ω \pm 15 % (at 20 °C)

Output data

Switching

Contact type	2 changeover contacts
Type of switch contact	Single contact
Drive and function	monostable
Contact material	AgNi
Maximum switching voltage	250 V AC/DC
Minimum switching voltage	5 V (at 10 mA)
Limiting continuous current	8 A
Maximum inrush current	25 A (20 ms)

Single relay - REL-MR-110DC/21-21

2961202

<https://www.phoenixcontact.com/de/produkte/2961202>

Min. switching current	10 mA (At 5 V)
Interrupting rating (ohmic load) max.	190 W (at 24 V DC)
	85 W (at 48 V DC)
	60 W (at 60 V DC)
	44 W (at 110 V DC)
	60 W (at 220 V DC)
	2000 VA (for 250 V AC)
Switching capacity	2 A (at 24 V, DC13)
	0.2 A (at 250 V, DC13)
	3 A (at 24 V, AC15)
	3 A (at 120 V, AC15)
	3 A (at 250 V, AC15)
Motor load according to UL 508	1/4 HP, 120 V AC
	1/2 HP, 240 V AC

Connection data

Connection method	Solder connection
-------------------	-------------------

Dimensions

Dimensional drawing	
Width	12.7 mm
Height	29 mm
Depth	15.7 mm

Environmental and real-life conditions

Ambient conditions

Degree of protection	RT III
Ambient temperature (operation)	-40 °C ... 85 °C
Ambient temperature (storage/transport)	-40 °C ... 85 °C

Approval data

Corrosive gas test

Identification	ISA-S71.04. G3 Harsh Group
	EN 60068-2-60

Standards and regulations

Standards/regulations	IEC 60664
	EN 50178
	EN 61810-1

Single relay - REL-MR-110DC/21-21



2961202

<https://www.phoenixcontact.com/de/produkte/2961202>

Mounting

Assembly instructions	Can be aligned without spacing ($> 70\text{ °C} \geq 2.5\text{ mm}$)
Mounting position	any

Single relay - REL-MR-110DC/21-21

2961202

<https://www.phoenixcontact.com/de/produkte/2961202>

Drawings

Drilling plan/solder pad geometry

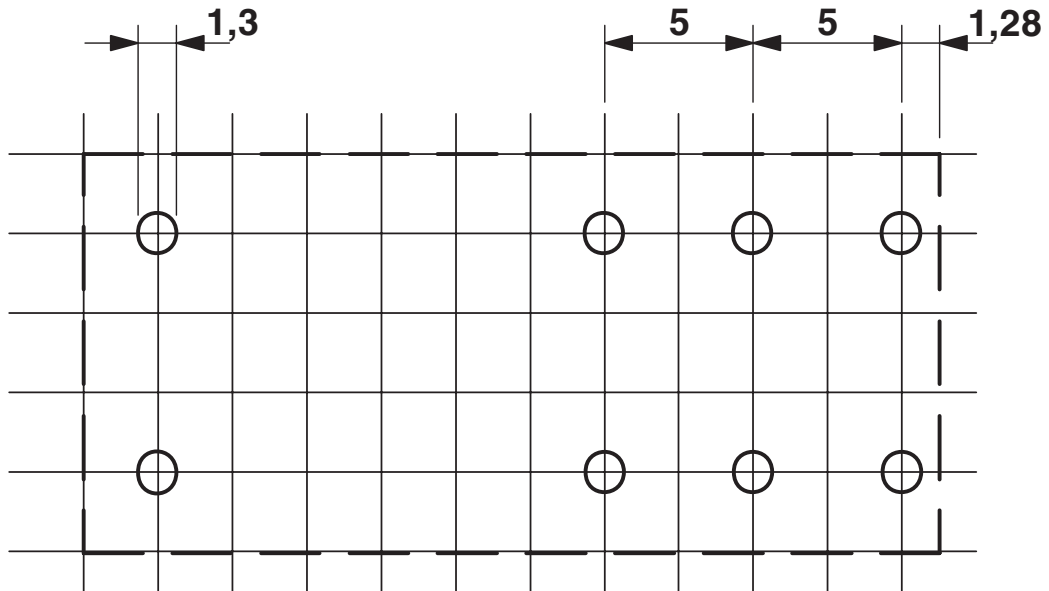

a = pitch division 2.5 mm

Circuit diagram

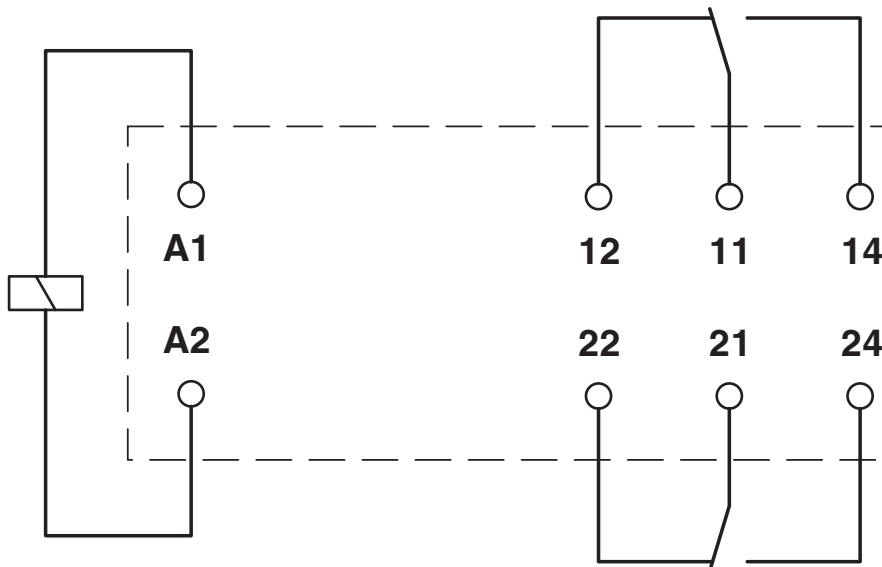

Single relay - REL-MR-110DC/21-21

2961202

<https://www.phoenixcontact.com/de/produkte/2961202>

Diagram

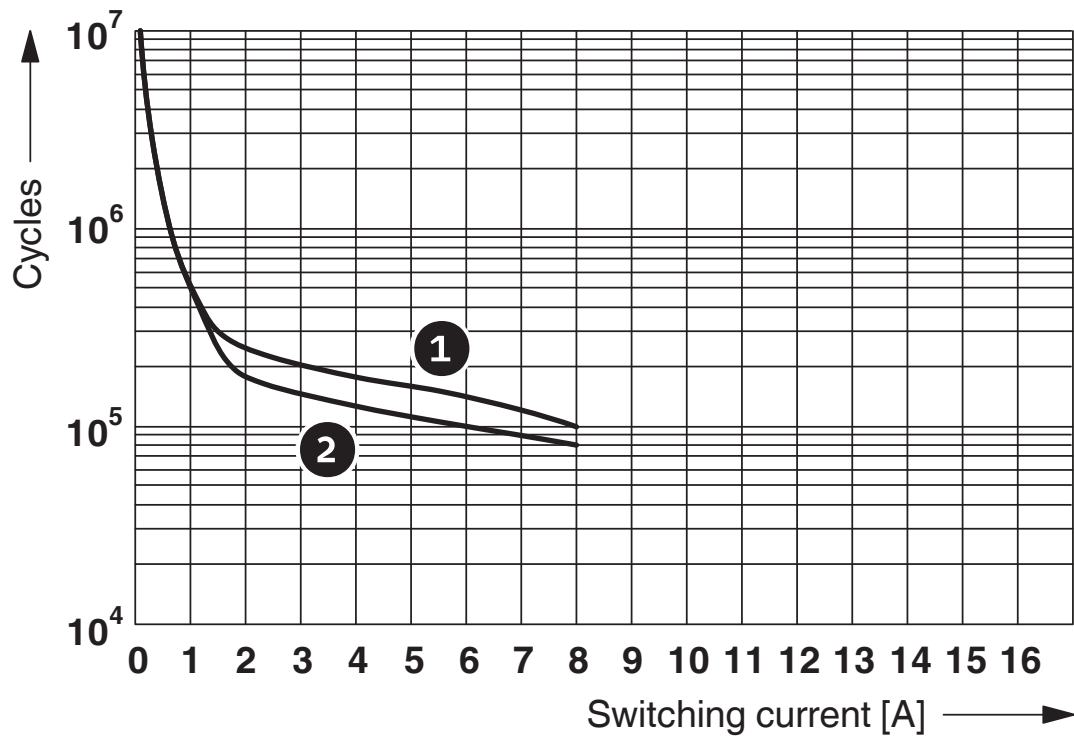

- ① 250 V AC, ohmic load (DC coils)
- ② 250 V AC, ohmic load (AC coils)

Electrical service life

Single relay - REL-MR-110DC/21-21

2961202

<https://www.phoenixcontact.com/de/produkte/2961202>

Diagram

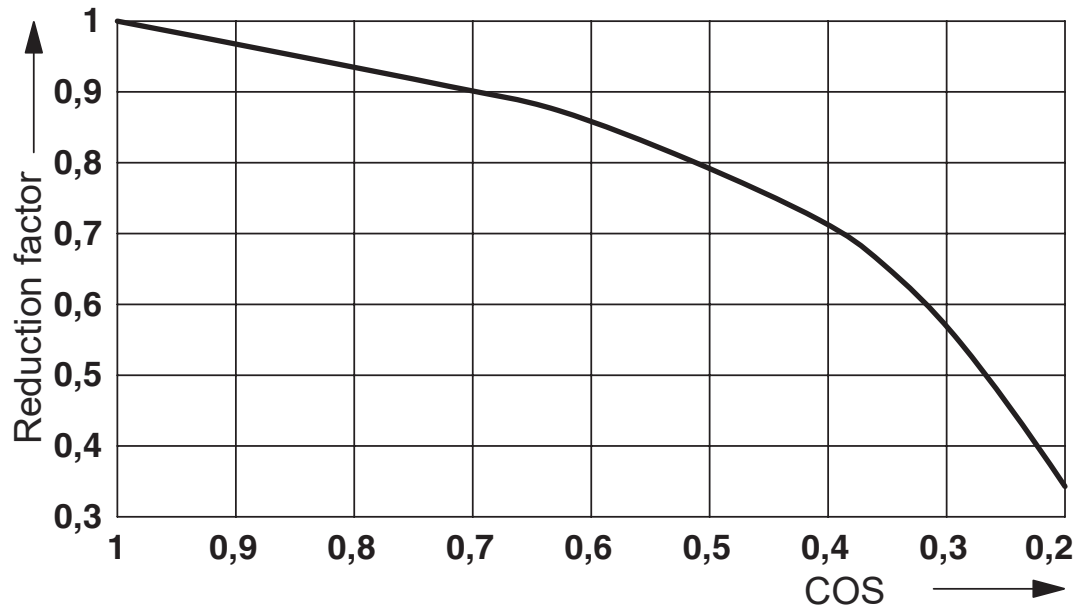

Service life reduction factor with various cos phi

Single relay - REL-MR-110DC/21-21

2961202

<https://www.phoenixcontact.com/de/produkte/2961202>

Diagram

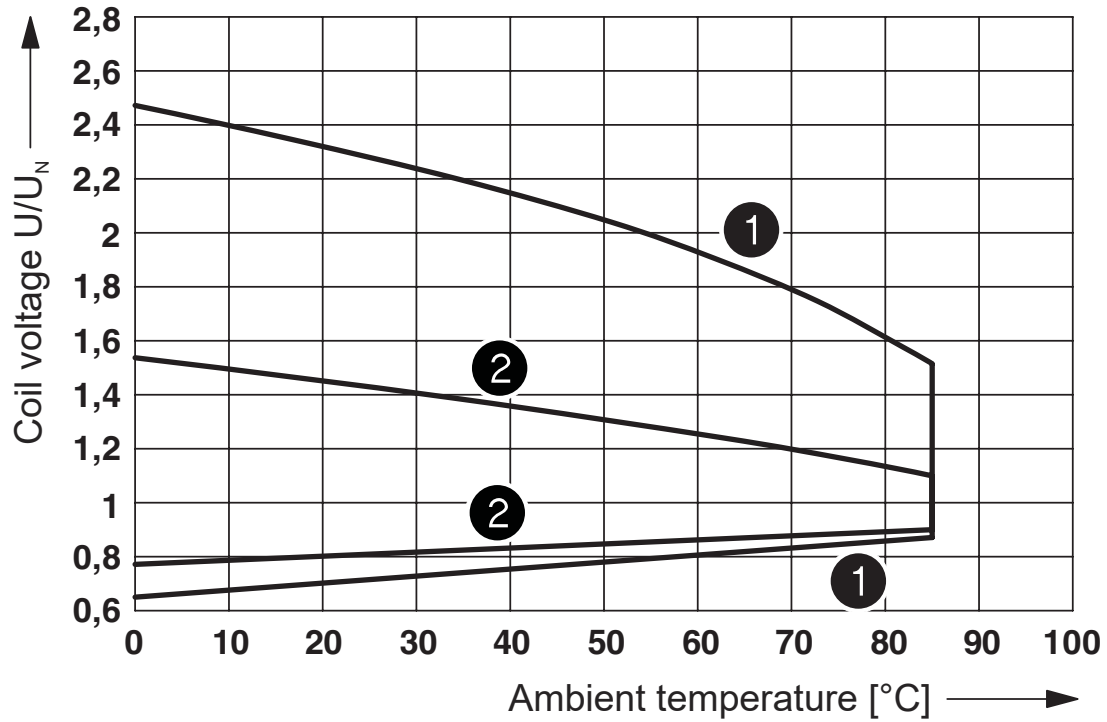

- ① DC coils
- ② AC coils

Operating voltage range

Single relay - REL-MR-110DC/21-21

2961202

<https://www.phoenixcontact.com/de/produkte/2961202>

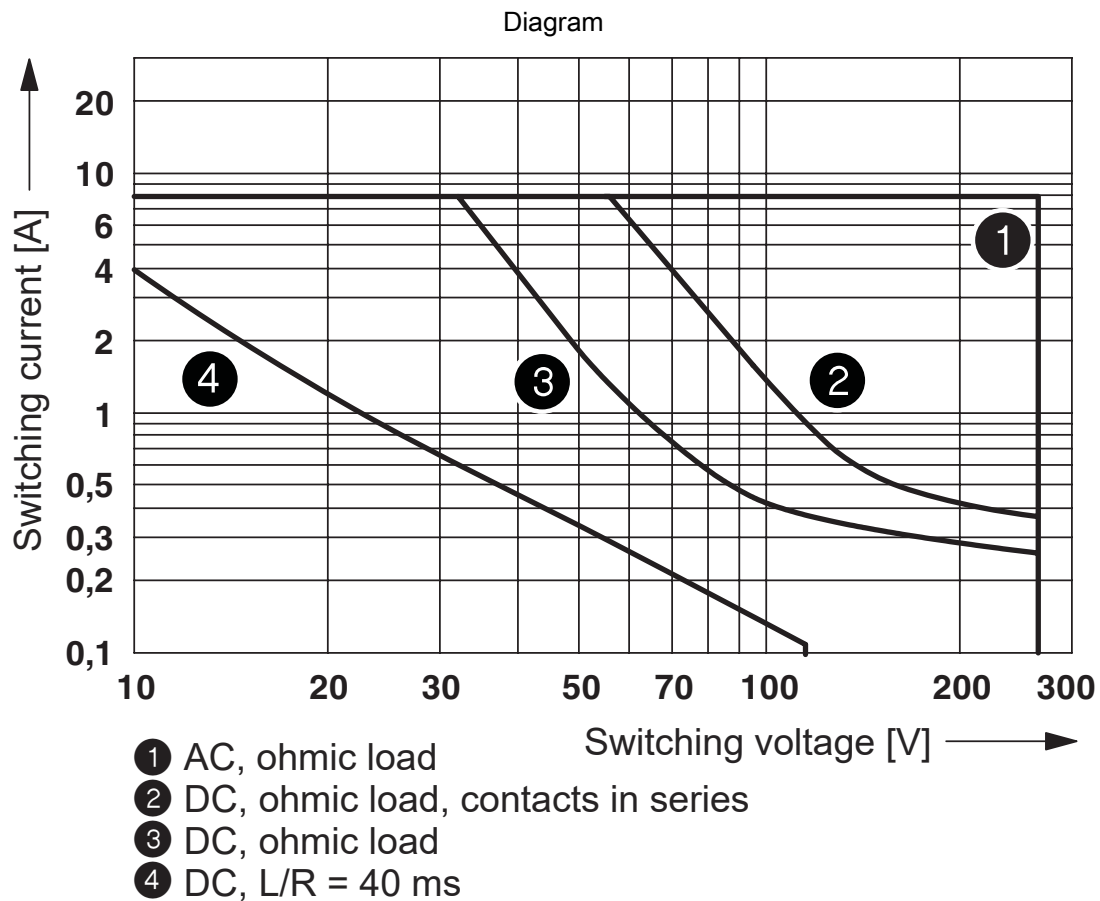

Interrupting rating

Dimensional drawing

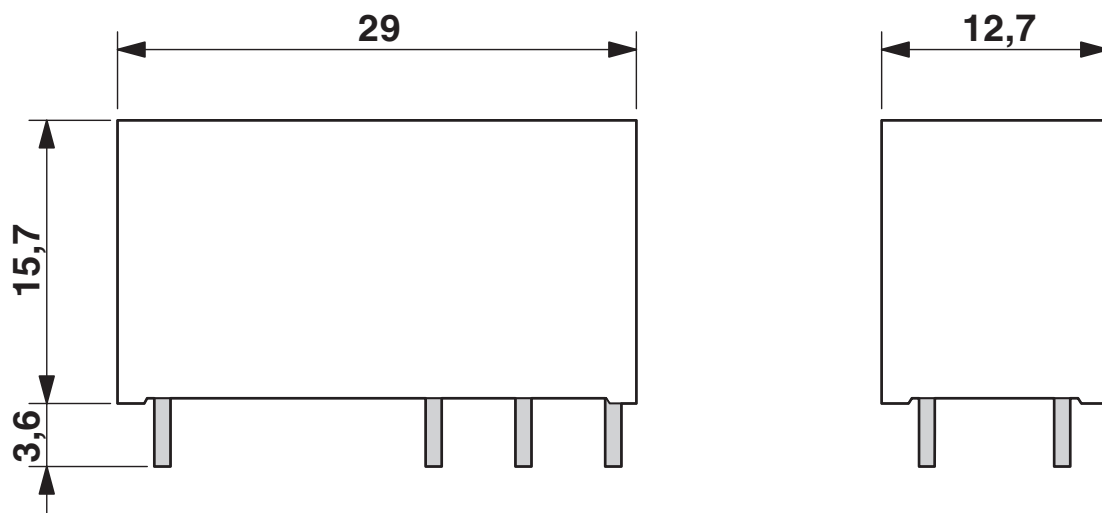

Single relay - REL-MR-110DC/21-21



2961202

<https://www.phoenixcontact.com/de/produkte/2961202>

Approvals



cUL Recognized
Approval ID: FILE E 228652



UL Recognized
Approval ID: FILE E 228652



EAC
Approval ID: TR_TS_D_00573_c



UL Recognized
Approval ID: FILE E 228652



EAC
Approval ID: RU*C-DE.*08.B.00010



VDE Zeichengenehmigung
Approval ID: 40007758

	Nominal Voltage U_N	Nominal Current I_N	Cross Section AWG	Cross Section mm^2
Reports with production monitoring			-	-



PRS
Approval ID: TE/2109/880590/16



cUL Recognized
Approval ID: FILE E 228652

Single relay - REL-MR-110DC/21-21



2961202

<https://www.phoenixcontact.com/de/produkte/2961202>

Classifications

ECLASS

ECLASS-9.0	27371601
ECLASS-10.0.1	27371601
ECLASS-11.0	27371601

ETIM

ETIM 8.0	EC001437
----------	----------

UNSPSC

UNSPSC 21.0	39122300
-------------	----------

Single relay - REL-MR-110DC/21-21



2961202

<https://www.phoenixcontact.com/de/produkte/2961202>

Environmental Product Compliance

China RoHS

Environmentally friendly use period: unlimited = EFUP-e

No hazardous substances above threshold values

Single relay - REL-MR-110DC/21-21

2961202

<https://www.phoenixcontact.com/de/produkte/2961202>

Accessories

Relay base

Relay base - PLC-BPT-120UC/21-21 - 2900287

<https://www.phoenixcontact.com/de/produkte/2900287>



14 mm PLC basic terminal block with Push-in connection, without relay or solid-state relay, for mounting on DIN rail NS 35/7,5, 2 changeover contacts, input voltage 120 V AC/DC

Relay base

Relay base - PLC-BSC-120UC/21-21 - 2967031

<https://www.phoenixcontact.com/de/produkte/2967031>



14 mm PLC basic terminal block with screw connection, without relay or solid-state relay, for mounting on DIN rail NS 35/7,5, 2 changeover contacts, input voltage 120 V AC/DC

Single relay - REL-MR-110DC/21-21

2961202

<https://www.phoenixcontact.com/de/produkte/2961202>

Relay base

Relay base - PLC-BPT-230UC/21-21 - 2900288

<https://www.phoenixcontact.com/de/produkte/2900288>



14 mm PLC basic terminal block with Push-in connection, without relay or solid-state relay, for mounting on DIN rail NS 35/7,5, 2 changeover contacts, input voltage 230 V AC/DC

Relay base

Relay base - PLC-BSC-230UC/21-21 - 2967044

<https://www.phoenixcontact.com/de/produkte/2967044>



14 mm PLC basic terminal block with screw connection, without relay or solid-state relay, for mounting on DIN rail NS 35/7,5, 2 changeover contacts, input voltage 230 V AC/DC

Single relay - REL-MR-110DC/21-21

2961202

<https://www.phoenixcontact.com/de/produkte/2961202>

Relay base

Relay base - PLC-BSC-120UC/21-21/SO46 - 2980416

<https://www.phoenixcontact.com/de/produkte/2980416>



14 mm PLC basic terminal block with interference current and interference voltage protection on the control side, with screw connection, without relay or solid-state relay, for mounting on DIN rail NS 35/7,5, with integrated RCZ filter, 2 changeover contacts, input voltage 120 V AC

Relay base

Relay base - PLC-BSC-230UC/21-21/SO46 - 2980429

<https://www.phoenixcontact.com/de/produkte/2980429>



14 mm PLC basic terminal block with interference current and interference voltage protection on the control side, with screw connection, without relay or solid-state relay, for mounting on DIN rail NS 35/7,5, with integrated RCZ filter, 2 changeover contacts, input voltage 230 V AC

Single relay - REL-MR-110DC/21-21

2961202

<https://www.phoenixcontact.com/de/produkte/2961202>

Relay base

Relay base - RIF-1-BPT/2X21 - 2900931

<https://www.phoenixcontact.com/de/produkte/2900931>



Relay base RIF-1..., for miniature power relay with 1 or 2 changeover contacts or solid-state relays of the same design, Push-in connection, plug-in option for input/interference suppression modules, for mounting on NS 35/7,5

Relay base

Relay base - RIF-1-BSC/2X21 - 2900930

<https://www.phoenixcontact.com/de/produkte/2900930>



RIF-1... relay base, for miniature power relay with 1 or 2 changeover contacts or identical solid-state relays, screw connection, plug-in option for input/interference suppression modules, for mounting on NS 35/7,5

Phoenix Contact 2022 © - all rights reserved
<https://www.phoenixcontact.com>

PHOENIX CONTACT Deutschland GmbH
Flachsmarktstraße 8
D-32825 Blomberg
+49 52 35/3-1 20 00
info@phoenixcontact.de