

# PCB connector - IC 2,5/14-ST-5,08

1786297

<https://www.phoenixcontact.com/de/produkte/1786297>

Please be informed that the data shown in this PDF document is generated from our Online Catalog. Please find the complete data in the user documentation. Our General Terms of Use for Downloads are valid.



PCB connector, nominal cross section: 2.5 mm<sup>2</sup>, color: green, nominal current: 12 A, rated voltage (III/2): 320 V, contact surface: Tin, type of contact: Male connector, number of potentials: 14, number of rows: 1, number of positions: 14, number of connections: 14, product range: IC 2,5/..-ST, pitch: 5.08 mm, connection method: Screw connection with tension sleeve, screw head form: L Slotted, conductor/PCB connection direction: 0 °, locking clip: - without locking clip, plug-in system: COMBICON MSTB 2,5, locking: without, mounting: without, type of packaging: packed in cardboard

## Your advantages

- Well-known connection principle allows worldwide use
- Easy PCB replacement thanks to plug-in modules
- Inverted connector with pin contacts for touch-proof device outputs or free-hanging cable/cable connections
- Can be combined with the MSTB 2,5 range
- Low temperature rise, thanks to maximum contact force

# PCB connector - IC 2,5/14-ST-5,08



1786297

<https://www.phoenixcontact.com/de/produkte/1786297>

## Commercial Data

Item number	1786297
Packing unit	50 pc
Minimum order quantity	50 pc
Sales Key	E1 - Leiterplattenanschl.
Product Key	AACADA
Catalog Page	Page 272 (C-1-2013)
GTIN	4017918042448
Weight per Piece (including packing)	23,479 g
Weight per Piece (excluding packing)	22,714 g
Customs tariff number	85366990
Country of origin	DE

# PCB connector - IC 2,5/14-ST-5,08



1786297

<https://www.phoenixcontact.com/de/produkte/1786297>

## Technical Data

### Product properties

Type	Inverted
Product line	COMBICON Connectors M
Product type	PCB plug
Number of positions	14
Pitch	5.08 mm
Number of connections	14
Number of rows	1
Mounting flange	without
Number of potentials	14

### Electrical properties

Nominal current $I_N$	12 A
Nominal voltage $U_N$	320 V
Pollution degree	3
Contact resistance	2.9 mΩ
Rated voltage (III/3)	250 V
Rated surge voltage (III/3)	4 kV
Rated voltage (III/2)	320 V
Rated surge voltage (III/2)	4 kV

### Connection data

#### Connection technology

Type	Inverted
Connector system	COMBICON MSTB 2,5
Nominal cross section	2.5 mm <sup>2</sup>
Type of contact	Male connector

#### Interlock

Locking type	without
Mounting flange	without

#### Conductor connection

Connection method	Screw connection with tension sleeve
Conductor/PCB connection direction	0 °
Conductor cross section solid	0.2 mm <sup>2</sup> ... 2.5 mm <sup>2</sup>
Conductor cross section flexible	0.2 mm <sup>2</sup> ... 2.5 mm <sup>2</sup>
Conductor cross section AWG	24 ... 12
Conductor cross section flexible, with ferrule without plastic sleeve	0.25 mm <sup>2</sup> ... 2.5 mm <sup>2</sup>
Conductor cross section, flexible, with ferrule, with plastic sleeve	0.25 mm <sup>2</sup> ... 2.5 mm <sup>2</sup>
2 conductors with same cross section, solid	0.2 mm <sup>2</sup> ... 1 mm <sup>2</sup>

# PCB connector - IC 2,5/14-ST-5,08

1786297

<https://www.phoenixcontact.com/de/produkte/1786297>

2 conductors with same cross section, flexible	0.2 mm <sup>2</sup> ... 1.5 mm <sup>2</sup>
2 conductors with same cross section, flexible, with ferrule without plastic sleeve	0.25 mm <sup>2</sup> ... 1 mm <sup>2</sup>
2 conductors with the same cross section, flexible, with TWIN ferrule with plastic sleeve	0.5 mm <sup>2</sup> ... 1.5 mm <sup>2</sup>
Cylindrical gauge a x b / diameter	2.8 mm x 2.0 mm / 2.4 mm
Stripping length	7 mm
Torque	0.5 Nm ... 0.6 Nm

## Material specifications

### Material data - contact

Note	WEEE/RoHS-compliant, free of whiskers according to IEC 60068-2-82/JEDEC JESD 201
Contact material	Cu alloy
Surface characteristics	Tin-plated
Metal surface terminal point (top layer)	Tin (5 - 7 µm Sn)
Metal surface terminal point (middle layer)	Nickel (2 - 3 µm Ni)
Metal surface contact area (top layer)	Tin (5 - 7 µm Sn)
Metal surface contact area (middle layer)	Nickel (2 - 3 µm Ni)

### Material data - housing

Housing color	green (6021)
Insulating material	PA
Insulating material group	I
CTI according to IEC 60112	600
Flammability rating according to UL 94	V0
Glow wire flammability index GWFI according to EN 60695-2-12	850
Glow wire ignition temperature GWIT according to EN 60695-2-13	775
Temperature for the ball pressure test according to EN 60695-10-2	125 °C

## Dimensions

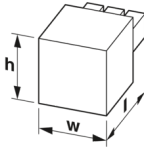
Dimensional drawing	
Pitch	5.08 mm
Width [w]	72.62 mm
Height [h]	15 mm
Length [l]	19.2 mm
Installed height	15 mm

## Mounting

# PCB connector - IC 2,5/14-ST-5,08



1786297

<https://www.phoenixcontact.com/de/produkte/1786297>

Drive form screw head	Slotted (L)
-----------------------	-------------

## Notes

Notes on operation	In accordance with IEC 61984, COMBICON connectors have no switching power (COC). During designated use, they must not be plugged in or disconnected when carrying voltage or under load.
--------------------	--

## Mechanical tests

### Test for conductor damage and slackening

Specification	IEC 60999-1:1999-11
Result	Test passed

### Pull-out test

Specification	IEC 60999-1:1999-11
Conductor cross section/conductor type/tractive force setpoint/actual value	0.2 mm <sup>2</sup> / solid / > 10 N
	0.2 mm <sup>2</sup> / flexible / > 10 N
	2.5 mm <sup>2</sup> / solid / > 50 N
	2.5 mm <sup>2</sup> / flexible / > 50 N

### Insertion and withdrawal forces

Result	Test passed
No. of cycles	25
Insertion strength per pos. approx.	8 N
Withdraw strength per pos. approx.	7 N

### Torque test

Specification	IEC 60999-1:1999-11
---------------	---------------------

### Resistance of inscriptions

Specification	IEC 60068-2-70:1995-12
Result	Test passed

### Polarization and coding

Specification	IEC 60512-13-5:2006-02
Result	Test passed

### Visual inspection

Specification	IEC 60512-1-1:2002-02
Result	Test passed

### Dimension check

Specification	IEC 60512-1-2:2002-02
Result	Test passed

## Environmental and real-life conditions

### Vibration test

Specification	IEC 60068-2-6:2007-12
---------------	-----------------------

# PCB connector - IC 2,5/14-ST-5,08



1786297

<https://www.phoenixcontact.com/de/produkte/1786297>

Frequency	10 - 150 - 10 Hz
Sweep speed	1 octave/min
Amplitude	0.35 mm (10 - 60.1 Hz)
Sweep speed	5g (60.1 - 150 Hz)
Test duration per axis	2.5 h

## Durability test

Specification	IEC 60512-9-1:2010-03
Impulse withstand voltage at sea level	4.8 kV
Contact resistance R <sub>1</sub>	2.9 mΩ
Contact resistance R <sub>2</sub>	3 mΩ
Insertion/withdrawal cycles	25
Insulation resistance, neighboring positions	> 5 MΩ

## Climatic test

Specification	ISO 6988:1985-02
Corrosive stress	0.2 dm <sup>3</sup> SO <sub>2</sub> on 300 dm <sup>3</sup> /40 °C/1 cycle
Thermal stress	100 °C/168 h
Power-frequency withstand voltage	2.21 kV

## Ambient conditions

Ambient temperature (operation)	-40 °C ... 100 °C (dependent on the derating curve)
Ambient temperature (storage/transport)	-40 °C ... 70 °C
Relative humidity (storage/transport)	30 % ... 70 %
Ambient temperature (assembly)	-5 °C ... 100 °C

## Electrical tests

### Thermal test | Test group C

Specification	IEC 60512-5-1:2002-02
Tested number of positions	16

### Insulation resistance

Specification	IEC 60512-3-1:2002-02
Insulation resistance, neighboring positions	> 5 MΩ

### Air clearances and creepage distances |

Specification	IEC 60664-1:2007-04
Insulating material group	I
Comparative tracking index (IEC 60112)	CTI 600
Rated insulation voltage (III/3)	250 V
Rated surge voltage (III/3)	4 kV
minimum clearance value - non-homogenous field (III/3)	3 mm
minimum creepage distance (III/3)	3.2 mm
Rated insulation voltage (III/2)	320 V
Rated surge voltage (III/2)	4 kV
minimum clearance value - non-homogenous field (III/2)	3 mm

# PCB connector - IC 2,5/14-ST-5,08



1786297

<https://www.phoenixcontact.com/de/produkte/1786297>

minimum creepage distance (III/2)	3 mm
Rated insulation voltage (II/2)	630 V
Rated surge voltage (II/2)	4 kV
minimum clearance value - non-homogenous field (II/2)	3 mm
minimum creepage distance (II/2)	3.2 mm

## Packaging specifications

Type of packaging	packed in cardboard
-------------------	---------------------

Drawings

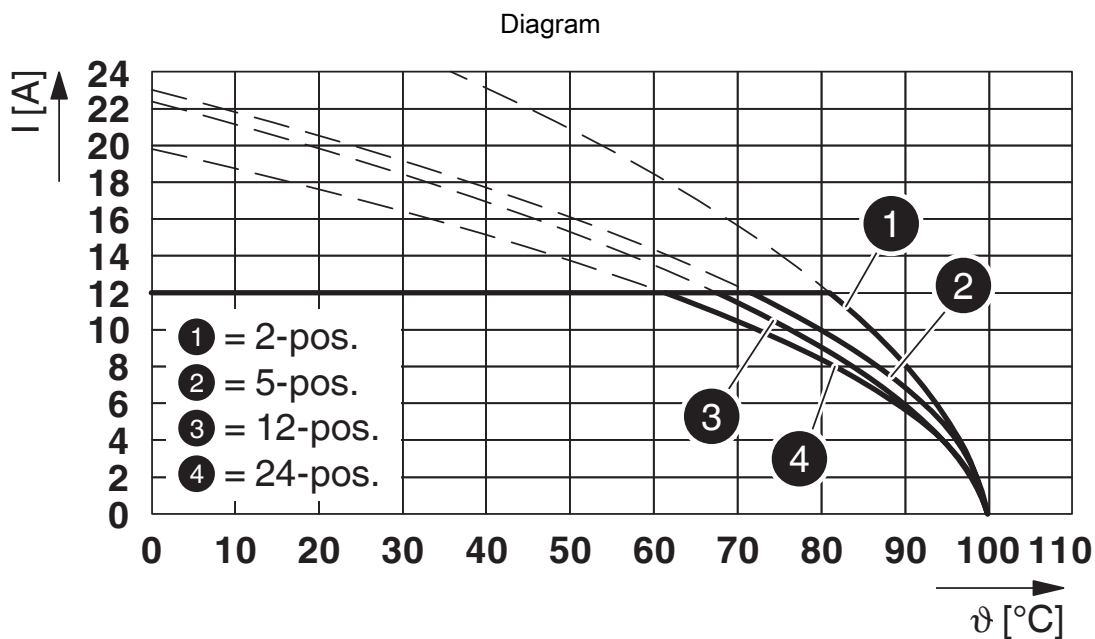

Type: IC 2,5/...-ST-5,08 with ICV 2,5/...-G-5,08

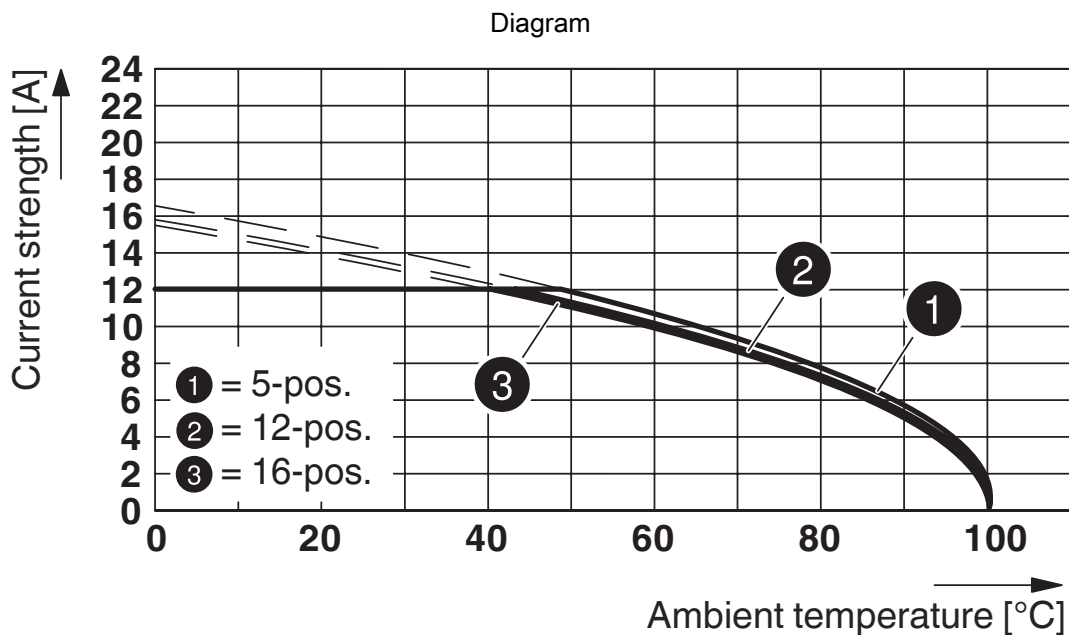

Type: (U)MSTBVK 2,5/...-ST-5,08 with IC 2,5/...-ST-5,08



# PCB connector - IC 2,5/14-ST-5,08

1786297

<https://www.phoenixcontact.com/de/produkte/1786297>

Dimensional drawing

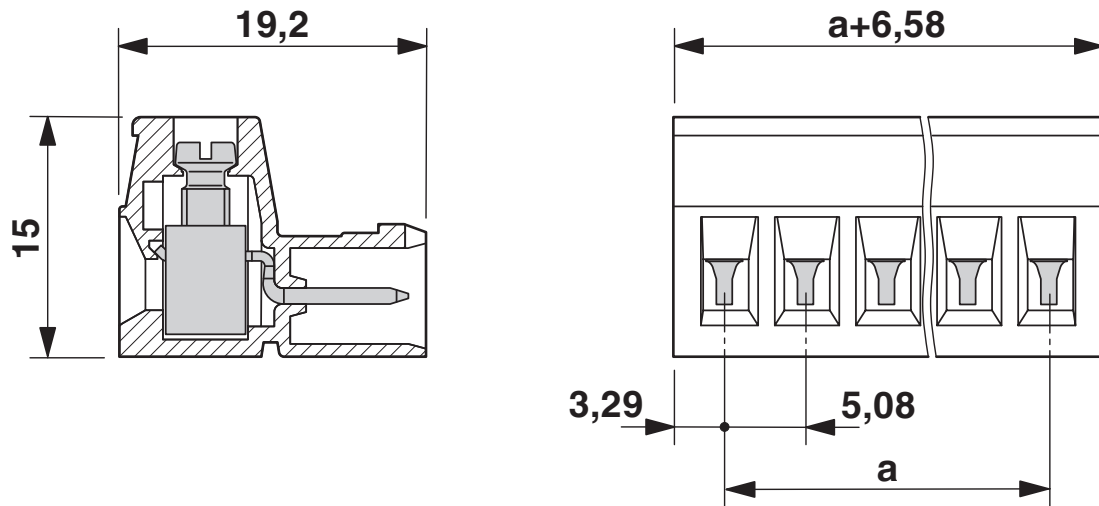

# PCB connector - IC 2,5/14-ST-5,08



1786297

<https://www.phoenixcontact.com/de/produkte/1786297>

## Approvals

 <b>CSA</b> Approval ID: 13631				
	Nominal Voltage $U_N$	Nominal Current $I_N$	Cross Section AWG	Cross Section $mm^2$
Use group B	300 V	10 A	28 - 12	-
Use group D	300 V	10 A	28 - 12	-

 <b>IECEE CB Scheme</b> Approval ID: DE1-60988-B1B2				
	Nominal Voltage $U_N$	Nominal Current $I_N$	Cross Section AWG	Cross Section $mm^2$
	250 V	12 A	-	0.2 - 2.5

 <b>EAC</b> Approval ID: B.01687				
--	--	--	--	--

 <b>cULus Recognized</b> Approval ID: E60425-19931014				
	Nominal Voltage $U_N$	Nominal Current $I_N$	Cross Section AWG	Cross Section $mm^2$
Use group B	250 V	12 A	30 - 12	-
Use group D	300 V	10 A	30 - 12	-

 <b>VDE Zeichengenehmigung</b> Approval ID: 40050694				
	Nominal Voltage $U_N$	Nominal Current $I_N$	Cross Section AWG	Cross Section $mm^2$
	250 V	12 A	-	0.2 - 2.5

# PCB connector - IC 2,5/14-ST-5,08



1786297

<https://www.phoenixcontact.com/de/produkte/1786297>

## Classifications

### ECLASS

ECLASS-9.0	27440309
ECLASS-10.0.1	27440309
ECLASS-11.0	27460202

### ETIM

ETIM 8.0	EC002638
----------	----------

### UNSPSC

UNSPSC 21.0	39121400
-------------	----------

# PCB connector - IC 2,5/14-ST-5,08



1786297

<https://www.phoenixcontact.com/de/produkte/1786297>

## Environmental Product Compliance

REACH SVHC	Lead 7439-92-1
China RoHS	Environmentally Friendly Use Period = 50 years
	For information on hazardous substances, refer to the manufacturer's declaration available under "Downloads"

# PCB connector - IC 2,5/14-ST-5,08

1786297

<https://www.phoenixcontact.com/de/produkte/1786297>

## Accessories

### Accessories

Accessories - MSTB-BL - 1755477

<https://www.phoenixcontact.com/de/produkte/1755477>



Keying cap, for forming sections, plugs onto header pin, green insulating material

---

## Insertion bridge

Insertion bridge - EBP 2- 5 - 1733169

<https://www.phoenixcontact.com/de/produkte/1733169>

Insertion bridge for connectors with 5.0 mm or 5.08 mm pitch



# PCB connector - IC 2,5/14-ST-5,08

1786297

<https://www.phoenixcontact.com/de/produkte/1786297>

## Screwdriver

Screwdriver - SZS 0,6X3,5 - 1205053

<https://www.phoenixcontact.com/de/produkte/1205053>



Actuation tool, for ST terminal blocks, insulated, also suitable for use as a bladed screwdriver, size: 0.6 x 3.5 x 100 mm, 2-component grip, with non-slip grip

---

## Coding section

Coding section - CR-MSTB - 1734401

<https://www.phoenixcontact.com/de/produkte/1734401>



Coding section, inserted into the recess in the header or the inverted plug, red insulating material

# PCB connector - IC 2,5/14-ST-5,08

1786297

<https://www.phoenixcontact.com/de/produkte/1786297>

## Marker card

Marker card - SK 5,08/3,8:FORTL.ZAHLEN - 0804293

<https://www.phoenixcontact.com/de/produkte/0804293>

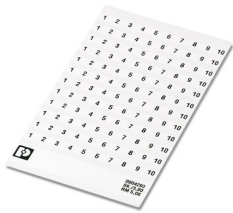

Marker card, white, labeled, horizontal: consecutive numbers 1 ... 10, 11 ... 20, etc. up to 91 ... (99)100, mounting type: adhesive, for terminal block width: 5.08 mm, lettering field size: 5.08 x 3.8 mm

---

## Cable housing

Cable housing - KGS-MSTB 2,5/14 - 1783834

<https://www.phoenixcontact.com/de/produkte/1783834>



Cable housing, pitch: 0 mm, number of positions: 14, dimension a: 70 mm, color: green

# PCB connector - IC 2,5/14-ST-5,08

1786297

<https://www.phoenixcontact.com/de/produkte/1786297>

## PCB connector

PCB connector - MSTB 2,5/14-STZ-5,08 - 1764264

<https://www.phoenixcontact.com/de/produkte/1764264>

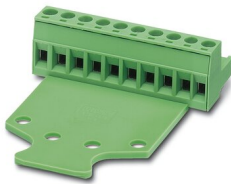

PCB connector, nominal cross section: 2.5 mm<sup>2</sup>, color: green, nominal current: 12 A, rated voltage (III/2): 320 V, contact surface: Tin, type of contact: Female connector, number of potentials: 14, number of rows: 1, number of positions: 14, number of connections: 14, product range: MSTB 2,5/...-STZ, pitch: 5.08 mm, connection method: Screw connection with tension sleeve, screw head form: L Slotted, conductor/PCB connection direction: 0 °, locking clip: - Locking clip, plug-in system: COMBICON MSTB 2,5, locking: without, mounting: without, type of packaging: packed in cardboard

---

## Printed-circuit board connector

Printed-circuit board connector - UMSTBVK 2,5/14-ST-5,08 - 1833933

<https://www.phoenixcontact.com/de/produkte/1833933>



DIN rail connector, nominal cross section: 2.5 mm<sup>2</sup>, color: green, nominal current: 12 A, rated voltage (III/2): 320 V, contact surface: Tin, type of contact: Female connector, number of potentials: 14, number of rows: 1, number of positions: 14, number of connections: 14, product range: UMSTBVK 2,5/...-ST, pitch: 5.08 mm, connection method: Screw connection with tension sleeve, conductor/PCB connection direction: 0 °, plug-in system: COMBICON MSTB 2,5, locking: without, mounting: without, type of packaging: packed in cardboard



# PCB connector - IC 2,5/14-ST-5,08

1786297

<https://www.phoenixcontact.com/de/produkte/1786297>

## PCB connector

PCB connector - MSTBC 2,5/14-STZ-5,08 - 1809624

<https://www.phoenixcontact.com/de/produkte/1809624>



PCB connector, nominal cross section: 2.5 mm<sup>2</sup>, color: green, nominal current: 12 A, rated voltage (III/2): 320 V, type of contact: Female connector, number of potentials: 14, number of rows: 1, number of positions: 14, number of connections: 14, product range: MSTBC 2,5/...-STZ, pitch: 5.08 mm, connection method: Crimp connection, conductor/PCB connection direction: 0 °, locking clip: - Locking clip, plug-in system: COMBICON MSTB 2,5, locking: without, mounting: without, type of packaging: packed in cardboard, Corresponding female crimp contacts with current [A] and conductor cross section range [mm<sup>2</sup>] data: 10A/MSTBC-MT 0,5-1,0 (3190564); 10A/MSTBC-MT 0,5-1,0 BA (3190645); 12A/MSTBC-MT 1,5-2,5 (3190551); 12A/MSTBC-MT 1,5-2,5 BA (3190658). BA = Bandkontakte

## PCB connector

PCB connector - MSTBC 2,5/14-ST-5,08 - 1808939

<https://www.phoenixcontact.com/de/produkte/1808939>



PCB connector, nominal cross section: 2.5 mm<sup>2</sup>, color: green, nominal current: 12 A, rated voltage (III/2): 320 V, type of contact: Female connector, number of potentials: 14, number of rows: 1, number of positions: 14, number of connections: 14, product range: MSTBC 2,5/...-ST, pitch: 5.08 mm, connection method: Crimp connection, conductor/PCB connection direction: 0 °, locking clip: - Locking clip, plug-in system: COMBICON MSTB 2,5, locking: without, mounting: without, type of packaging: packed in cardboard, Corresponding female crimp contacts with current [A] and conductor cross section range [mm<sup>2</sup>] data: 10A/MSTBC-MT 0,5-1,0 (3190564); 10A/MSTBC-MT 0,5-1,0 BA (3190645); 12A/MSTBC-MT 1,5-2,5 (3190551); 12A/MSTBC-MT 1,5-2,5 BA (3190658). BA = Bandkontakte

# PCB connector - IC 2,5/14-ST-5,08

1786297

<https://www.phoenixcontact.com/de/produkte/1786297>

## PCB connector

PCB connector - MVSTBW 2,5/14-ST-5,08 - 1792870

<https://www.phoenixcontact.com/de/produkte/1792870>

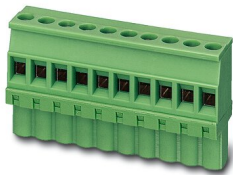

PCB connector, nominal cross section: 2.5 mm<sup>2</sup>, color: green, nominal current: 12 A, rated voltage (III/2): 320 V, contact surface: Tin, type of contact: Female connector, number of potentials: 14, number of rows: 1, number of positions: 14, number of connections: 14, product range: MVSTBW 2,5/..-ST, pitch: 5.08 mm, connection method: Screw connection with tension sleeve, screw head form: L Slotted, conductor/PCB connection direction: -90 °, locking clip: - Locking clip, plug-in system: COMBICON MSTB 2,5, locking: without, mounting: without, type of packaging: packed in cardboard

## PCB connector

PCB connector - MVSTBR 2,5/14-ST-5,08 - 1792362

<https://www.phoenixcontact.com/de/produkte/1792362>

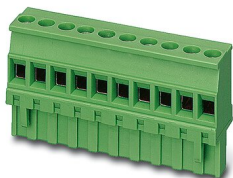

PCB connector, nominal cross section: 2.5 mm<sup>2</sup>, color: green, nominal current: 12 A, rated voltage (III/2): 320 V, contact surface: Tin, type of contact: Female connector, number of potentials: 14, number of rows: 1, number of positions: 14, number of connections: 14, product range: MVSTBR 2,5/..-ST, pitch: 5.08 mm, connection method: Screw connection with tension sleeve, screw head form: L Slotted, conductor/PCB connection direction: 90 °, locking clip: - Locking clip, plug-in system: COMBICON MSTB 2,5, locking: without, mounting: without, type of packaging: packed in cardboard

# PCB connector - IC 2,5/14-ST-5,08

1786297

<https://www.phoenixcontact.com/de/produkte/1786297>

## PCB header

PCB header - IC 2,5/14-G-5,08 - 1786527

<https://www.phoenixcontact.com/de/produkte/1786527>



PCB headers, nominal cross section: 2.5 mm<sup>2</sup>, color: green, nominal current: 12 A, rated voltage (III/2): 320 V, contact surface: Tin, type of contact: Female connector, number of potentials: 14, number of rows: 1, number of positions: 14, number of connections: 14, product range: IC 2,5/..-G, pitch: 5.08 mm, pin layout: Linear pinning, solder pin [P]: 3.5 mm, number of solder pins per potential: 2, plug-in system: COMBICON MSTB 2,5, Pin connector pattern alignment: Standard, locking: without, mounting: without, type of packaging: packed in cardboard

---

## PCB header

PCB header - ICV 2,5/14-G-5,08 - 1786064

<https://www.phoenixcontact.com/de/produkte/1786064>

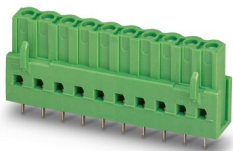

PCB headers, nominal cross section: 2.5 mm<sup>2</sup>, color: green, nominal current: 12 A, rated voltage (III/2): 320 V, contact surface: Tin, type of contact: Female connector, number of potentials: 14, number of rows: 1, number of positions: 14, number of connections: 14, product range: ICV 2,5/..-G, pitch: 5.08 mm, pin layout: Linear pinning, solder pin [P]: 3.6 mm, number of solder pins per potential: 2, plug-in system: COMBICON MSTB 2,5, Pin connector pattern alignment: Standard, locking: without, mounting: without, type of packaging: packed in cardboard

# PCB connector - IC 2,5/14-ST-5,08

1786297

<https://www.phoenixcontact.com/de/produkte/1786297>

## PCB connector

PCB connector - MSTBT 2,5/14-ST-5,08 - 1781108

<https://www.phoenixcontact.com/de/produkte/1781108>



PCB connector, nominal cross section: 2.5 mm<sup>2</sup>, color: green, nominal current: 12 A, rated voltage (III/2): 320 V, contact surface: Tin, type of contact: Female connector, number of potentials: 14, number of rows: 1, number of positions: 14, number of connections: 14, product range: MSTBT 2,5/...-ST, pitch: 5.08 mm, connection method: Screw connection with tension sleeve, screw head form: L Slotted, conductor/PCB connection direction: 0 °, locking clip: - Locking clip, plug-in system: COMBICON MSTB 2,5, locking: without, mounting: without, type of packaging: packed in cardboard

---

## PCB connector

PCB connector - FRONT-MSTB 2,5/14-ST-5,08 - 1777400

<https://www.phoenixcontact.com/de/produkte/1777400>



PCB connector, nominal cross section: 2.5 mm<sup>2</sup>, color: green, nominal current: 12 A, rated voltage (III/2): 320 V, contact surface: Tin, type of contact: Female connector, number of potentials: 14, number of rows: 1, number of positions: 14, number of connections: 14, product range: FRONT-MSTB 2,5/...-ST, pitch: 5.08 mm, connection method: Front screw connection, screw head form: L Slotted, conductor/PCB connection direction: 0 °, locking clip: - Locking clip, plug-in system: COMBICON MSTB 2,5, locking: without, mounting: without, type of packaging: packed in cardboard

# PCB connector - IC 2,5/14-ST-5,08

1786297

<https://www.phoenixcontact.com/de/produkte/1786297>

## PCB connector

PCB connector - MSTBP 2,5/14-ST-5,08 - 1769133

<https://www.phoenixcontact.com/de/produkte/1769133>



PCB connector, nominal cross section: 2.5 mm<sup>2</sup>, color: green, nominal current: 12 A, rated voltage (III/2): 320 V, contact surface: Tin, type of contact: Female connector, number of potentials: 14, number of rows: 1, number of positions: 14, number of connections: 14, product range: MSTBP 2,5/..-ST, pitch: 5.08 mm, connection method: Screw connection with tension sleeve, screw head form: L Slotted, conductor/PCB connection direction: 0 °, locking clip: - Locking clip, plug-in system: COMBICON MSTB 2,5, locking: without, mounting: without, type of packaging: packed in cardboard

---

## PCB connector

PCB connector - QC 1/14-ST-5,08 - 1883828

<https://www.phoenixcontact.com/de/produkte/1883828>

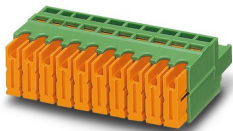

PCB connector, nominal cross section: 1 mm<sup>2</sup>, color: green, nominal current: 10 A, rated voltage (III/2): 630 V, contact surface: Tin, type of contact: Female connector, number of potentials: 14, number of rows: 1, number of positions: 14, number of connections: 14, product range: QC 1/..-ST, pitch: 5.08 mm, connection method: Displacement connection, conductor/PCB connection direction: 0 °, locking clip: - Locking clip, plug-in system: COMBICON MSTB 2,5, locking: without, mounting: without, type of packaging: packed in cardboard

# PCB connector - IC 2,5/14-ST-5,08

1786297

<https://www.phoenixcontact.com/de/produkte/1786297>

## PCB connector

PCB connector - FKCVR 2,5/14-ST-5,08 - 1874073

<https://www.phoenixcontact.com/de/produkte/1874073>

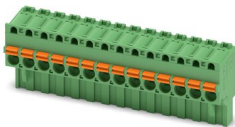

PCB connector, nominal cross section: 2.5 mm<sup>2</sup>, color: green, nominal current: 12 A, rated voltage (III/2): 320 V, contact surface: Tin, type of contact: Female connector, number of potentials: 14, number of rows: 1, number of positions: 14, number of connections: 14, product range: FKCVR 2,5/...-ST, pitch: 5.08 mm, connection method: Push-in spring connection, conductor/PCB connection direction: 90 °, locking clip: - Locking clip, plug-in system: COMBICON MSTB 2,5, locking: without, mounting: without, type of packaging: packed in cardboard

---

## PCB connector

PCB connector - FKC 2,5/14-ST-5,08 - 1873171

<https://www.phoenixcontact.com/de/produkte/1873171>



PCB connector, nominal cross section: 2.5 mm<sup>2</sup>, color: green, nominal current: 12 A, rated voltage (III/2): 320 V, contact surface: Tin, type of contact: Female connector, number of potentials: 14, number of rows: 1, number of positions: 14, number of connections: 14, product range: FKC 2,5/...-ST, pitch: 5.08 mm, connection method: Push-in spring connection, conductor/PCB connection direction: 0 °, locking clip: - Locking clip, plug-in system: COMBICON MSTB 2,5, locking: without, mounting: without, type of packaging: packed in cardboard

# PCB connector - IC 2,5/14-ST-5,08

1786297

<https://www.phoenixcontact.com/de/produkte/1786297>

## PCB connector

PCB connector - FKCVW 2,5/14-ST-5,08 - 1873773

<https://www.phoenixcontact.com/de/produkte/1873773>

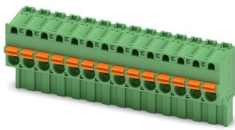

PCB connector, nominal cross section: 2.5 mm<sup>2</sup>, color: green, nominal current: 12 A, rated voltage (III/2): 320 V, contact surface: Tin, type of contact: Female connector, number of potentials: 14, number of rows: 1, number of positions: 14, number of connections: 14, product range: FKCVW 2,5/..-ST, pitch: 5.08 mm, connection method: Push-in spring connection, conductor/PCB connection direction: -90 °, locking clip: - Locking clip, plug-in system: COMBICON MSTB 2,5, locking: without, mounting: without, type of packaging: packed in cardboard

---

Phoenix Contact 2022 © - all rights reserved

<https://www.phoenixcontact.com>

PHOENIX CONTACT Deutschland GmbH

Flachsmarktstraße 8

D-32825 Blomberg

+49 52 35/3-1 20 00

[info@phoenixcontact.de](mailto:info@phoenixcontact.de)