

PCB connector - MSTB 2,5/ 2-STF-5,08

1777989

<https://www.phoenixcontact.com/de/produkte/1777989>

Please be informed that the data shown in this PDF document is generated from our Online Catalog. Please find the complete data in the user documentation. Our General Terms of Use for Downloads are valid.



PCB connector, nominal cross section: 2.5 mm², color: green, nominal current: 12 A, rated voltage (III/2): 320 V, contact surface: Tin, type of contact: Female connector, number of potentials: 2, number of rows: 1, number of positions: 2, number of connections: 2, product range: MSTB 2,5/..-STF, pitch: 5.08 mm, connection method: Screw connection with tension sleeve, screw head form: L Slotted, conductor/PCB connection direction: 0 °, locking clip: - without locking clip, plug-in system: COMBICON MSTB 2,5, locking: Screw locking, mounting: Screw flange, type of packaging: packed in cardboard

Your advantages

- Well-known connection principle allows worldwide use
- Low temperature rise, thanks to maximum contact force
- Screwable flange for superior mechanical stability
- Allows connection of two conductors

PCB connector - MSTB 2,5/ 2-STF-5,08



1777989

<https://www.phoenixcontact.com/de/produkte/1777989>

Commercial Data

Item number	1777989
Packing unit	100 pc
Minimum order quantity	100 pc
Sales Key	E1 - Leiterplattenanschl.
Product Key	AACAGD
Catalog Page	Page 263 (C-1-2013)
GTIN	4017918039851
Weight per Piece (including packing)	4,44 g
Weight per Piece (excluding packing)	4,244 g
Customs tariff number	85366990
Country of origin	DE

1777989

<https://www.phoenixcontact.com/de/produkte/1777989>

Technical Data

Product properties

Type	Standard
Product line	COMBICON Connectors M
Product type	PCB plug
Number of positions	2
Pitch	5.08 mm
Number of connections	2
Number of rows	1
Mounting flange	Screw flange
Number of potentials	2

Electrical properties

Nominal current I_N	12 A
Nominal voltage U_N	320 V
Pollution degree	3
Contact resistance	1.3 mΩ
Rated voltage (III/3)	250 V
Rated surge voltage (III/3)	4 kV
Rated voltage (III/2)	320 V
Rated surge voltage (III/2)	4 kV

Connection data

Connection technology

Type	Standard
Connector system	COMBICON MSTB 2,5
Nominal cross section	2.5 mm ²
Type of contact	Female connector

Interlock

Locking type	Screw locking
Mounting flange	Screw flange
Torque	0.3 Nm

Conductor connection

Connection method	Screw connection with tension sleeve
Conductor/PCB connection direction	0 °
Conductor cross section solid	0.2 mm ² ... 2.5 mm ²
Conductor cross section flexible	0.2 mm ² ... 2.5 mm ²
Conductor cross section AWG	24 ... 12
Conductor cross section flexible, with ferrule without plastic sleeve	0.25 mm ² ... 2.5 mm ²
Conductor cross section, flexible, with ferrule, with plastic sleeve	0.25 mm ² ... 2.5 mm ²

PCB connector - MSTB 2,5/ 2-STF-5,08

1777989

<https://www.phoenixcontact.com/de/produkte/1777989>

2 conductors with same cross section, solid	0.2 mm ² ... 1 mm ²
2 conductors with same cross section, flexible	0.2 mm ² ... 1.5 mm ²
2 conductors with same cross section, flexible, with ferrule without plastic sleeve	0.25 mm ² ... 1 mm ²
2 conductors with the same cross section, flexible, with TWIN ferrule with plastic sleeve	0.5 mm ² ... 1.5 mm ²
Cylindrical gauge a x b / diameter	2.8 mm x 2.0 mm / 2.4 mm
Stripping length	7 mm
Torque	0.5 Nm ... 0.6 Nm

Material specifications

Material data - contact

Note	WEEE/RoHS-compliant, free of whiskers according to IEC 60068-2-82/JEDEC JESD 201
Contact material	Cu alloy
Surface characteristics	hot-dip tin-plated
Metal surface terminal point (top layer)	Tin (5 - 7 µm Sn)
Metal surface contact area (top layer)	Tin (5 - 7 µm Sn)

Material data - housing

Housing color	green (6021)
Insulating material	PA
Insulating material group	I
CTI according to IEC 60112	600
Flammability rating according to UL 94	V0
Glow wire flammability index GWFI according to EN 60695-2-12	850
Glow wire ignition temperature GWIT according to EN 60695-2-13	775
Temperature for the ball pressure test according to EN 60695-10-2	125 °C

Dimensions

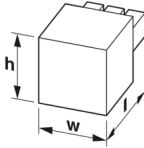
Dimensional drawing	
Pitch	5.08 mm
Width [w]	20.17 mm
Height [h]	15 mm
Length [l]	18.3 mm
Installed height	15 mm

Mounting

Drive form screw head	Slotted (L)
-----------------------	-------------

PCB connector - MSTB 2,5/ 2-STF-5,08



1777989

<https://www.phoenixcontact.com/de/produkte/1777989>

Flange

Tightening torque	0.3 Nm
-------------------	--------

Notes

Notes on operation	In accordance with IEC 61984, COMBICON connectors have no switching power (COC). During designated use, they must not be plugged in or disconnected when carrying voltage or under load.
--------------------	--

Mechanical tests

Test for conductor damage and slackening

Specification	IEC 60999-1:1999-11
Result	Test passed

Pull-out test

Specification	IEC 60999-1:1999-11
Conductor cross section/conductor type/tractive force setpoint/actual value	0.2 mm ² / solid / > 10 N
	0.2 mm ² / flexible / > 10 N
	2.5 mm ² / solid / > 50 N
	2.5 mm ² / flexible / > 50 N

Insertion and withdrawal forces

Result	Test passed
No. of cycles	25
Insertion strength per pos. approx.	8 N
Withdraw strength per pos. approx.	6 N

Torque test

Specification	IEC 60999-1:1999-11
---------------	---------------------

Contact holder in insert

Specification	IEC 60512-15-1:2008-05
Contact holder in insert Requirements >20 N	Test passed

Resistance of inscriptions

Specification	IEC 60068-2-70:1995-12
Result	Test passed

Polarization and coding

Specification	IEC 60512-13-5:2006-02
Result	Test passed

Visual inspection

Specification	IEC 60512-1-1:2002-02
Result	Test passed

Dimension check

Specification	IEC 60512-1-2:2002-02
---------------	-----------------------

Result	Test passed
--------	-------------

Environmental and real-life conditions

Vibration test

Specification	IEC 60068-2-6:2007-12
Frequency	10 - 150 - 10 Hz
Sweep speed	1 octave/min
Amplitude	0.35 mm (10 - 60.1 Hz)
Sweep speed	5g (60.1 - 150 Hz)
Test duration per axis	2.5 h

Durability test

Specification	IEC 60512-9-1:2010-03
Impulse withstand voltage at sea level	4.8 kV
Contact resistance R_1	1.3 m Ω
Contact resistance R_2	1.4 m Ω
Insertion/withdrawal cycles	25

Climatic test

Specification	ISO 6988:1985-02
Corrosive stress	0.2 dm ³ SO ₂ on 300 dm ³ /40 °C/1 cycle
Thermal stress	100 °C/168 h
Power-frequency withstand voltage	2.21 kV

Shocks

Specification	IEC 60068-2-27:2008-02
Pulse shape	Semi-sinusoidal
Acceleration	30g
Shock duration	18 ms
Test directions	X-, Y- and Z-axis (pos. and neg.)

Ambient conditions

Ambient temperature (operation)	-40 °C ... 100 °C (dependent on the derating curve)
Ambient temperature (storage/transport)	-40 °C ... 70 °C
Relative humidity (storage/transport)	30 % ... 70 %
Ambient temperature (assembly)	-5 °C ... 100 °C

Electrical tests

Thermal test | Test group C

Specification	IEC 60512-5-1:2002-02
Tested number of positions	12

Insulation resistance

Specification	IEC 60512-3-1:2002-02
Insulation resistance, neighboring positions	> 5 M Ω

PCB connector - MSTB 2,5/ 2-STF-5,08



1777989

<https://www.phoenixcontact.com/de/produkte/1777989>

Air clearances and creepage distances |

Specification	IEC 60664-1:2007-04
Insulating material group	I
Comparative tracking index (IEC 60112)	CTI 600
Rated insulation voltage (III/3)	250 V
Rated surge voltage (III/3)	4 kV
minimum clearance value - non-homogenous field (III/3)	3 mm
minimum creepage distance (III/3)	3.2 mm
Rated insulation voltage (III/2)	320 V
Rated surge voltage (III/2)	4 kV
minimum clearance value - non-homogenous field (III/2)	3 mm
minimum creepage distance (III/2)	3 mm
Rated insulation voltage (II/2)	630 V
Rated surge voltage (II/2)	4 kV
minimum clearance value - non-homogenous field (II/2)	3 mm
minimum creepage distance (II/2)	3.2 mm

Packaging specifications

Type of packaging	packed in cardboard
-------------------	---------------------

Drawings

Diagram

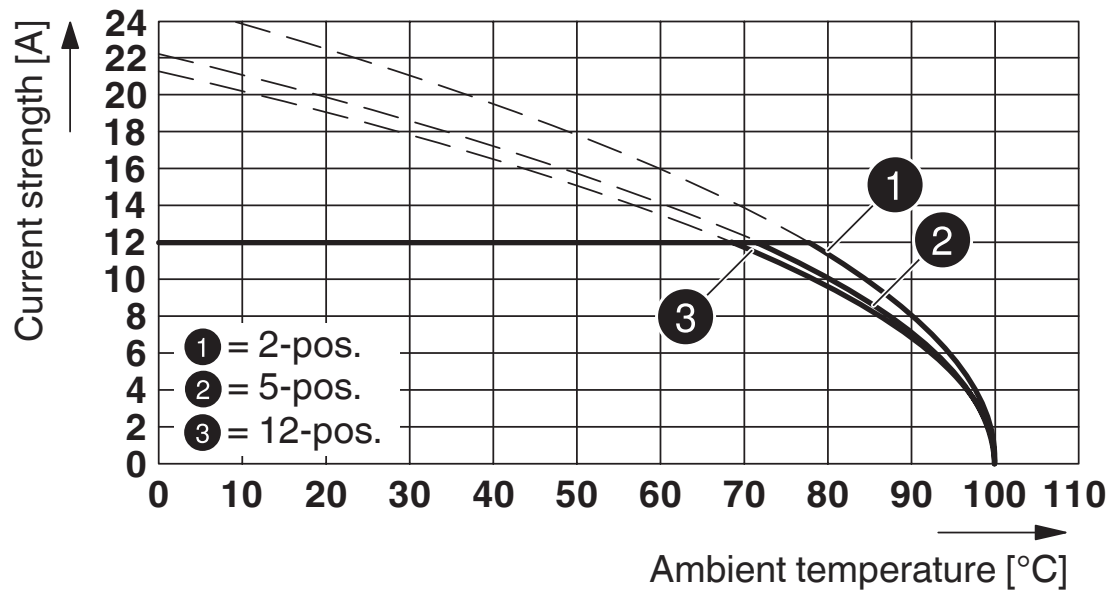

Type: MSTB 2,5/...-STF-5,08 with CCV 2,5/...-GF-5,08 P26THR

Dimensional drawing

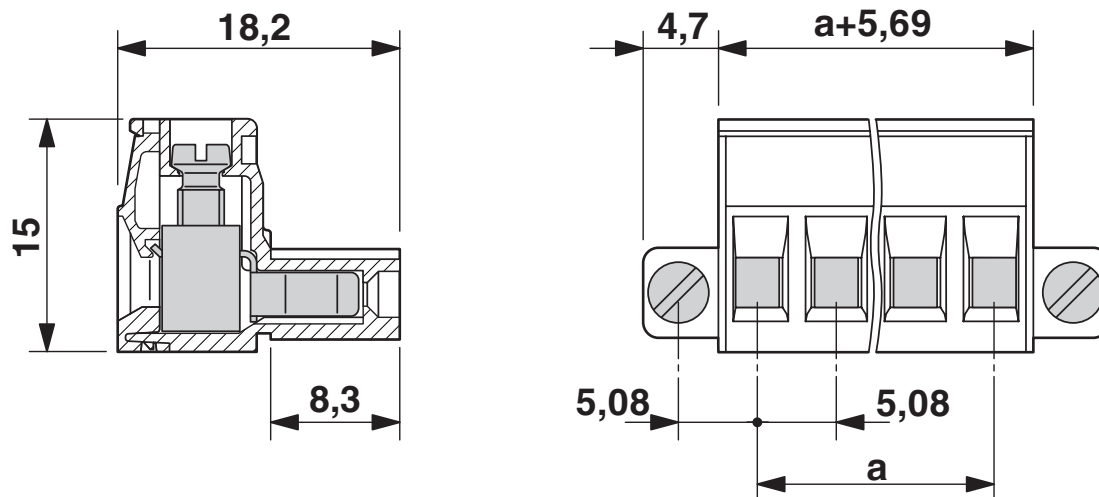

1777989

<https://www.phoenixcontact.com/de/produkte/1777989>

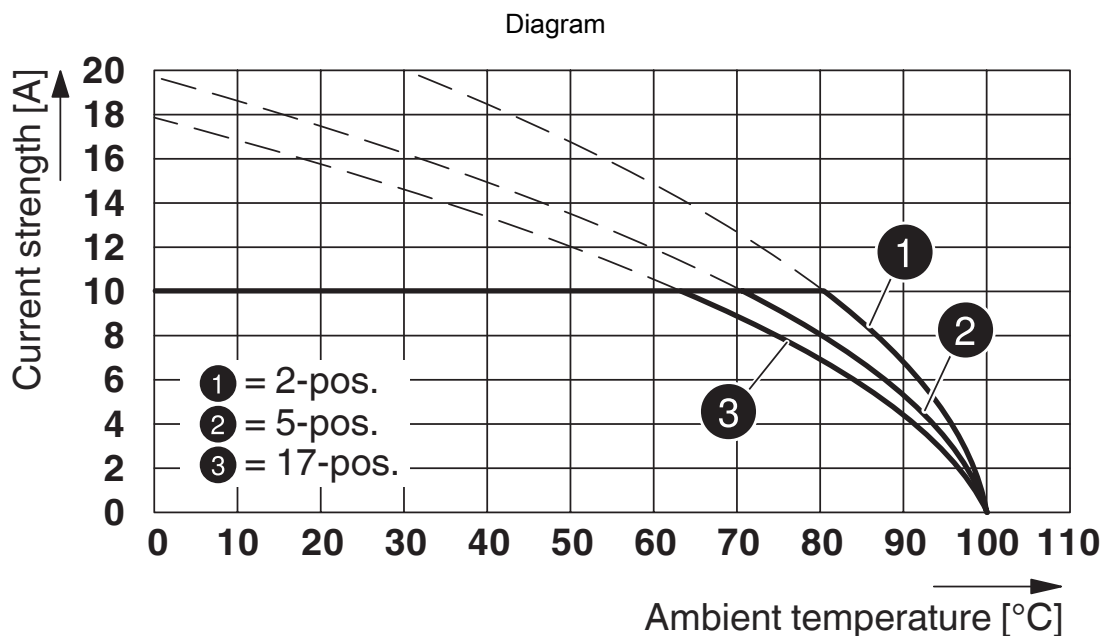

Type: MSTB 2,5/...-STF-5,08 with MDSTB 2,5/...-GF-5,08

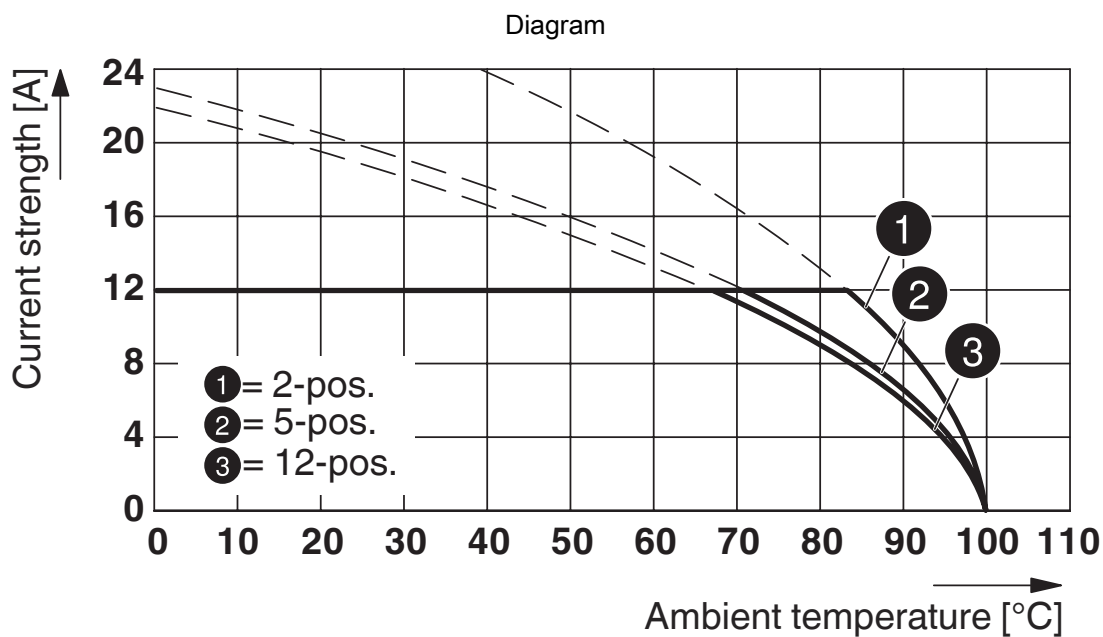

Type: MSTB 2,5/...-STF-5,08 with CC 2,5/...-GF-5,08 P26THR

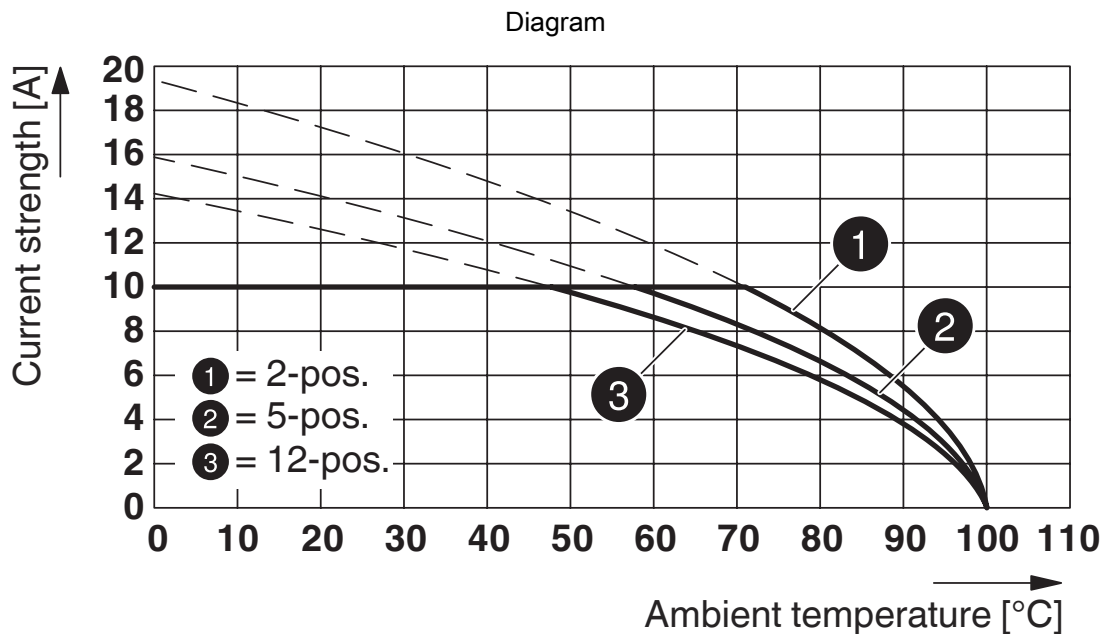

Type: MSTB 2,5/...-STF-5,08 with MDSTBV 2,5/...-GF-5,08

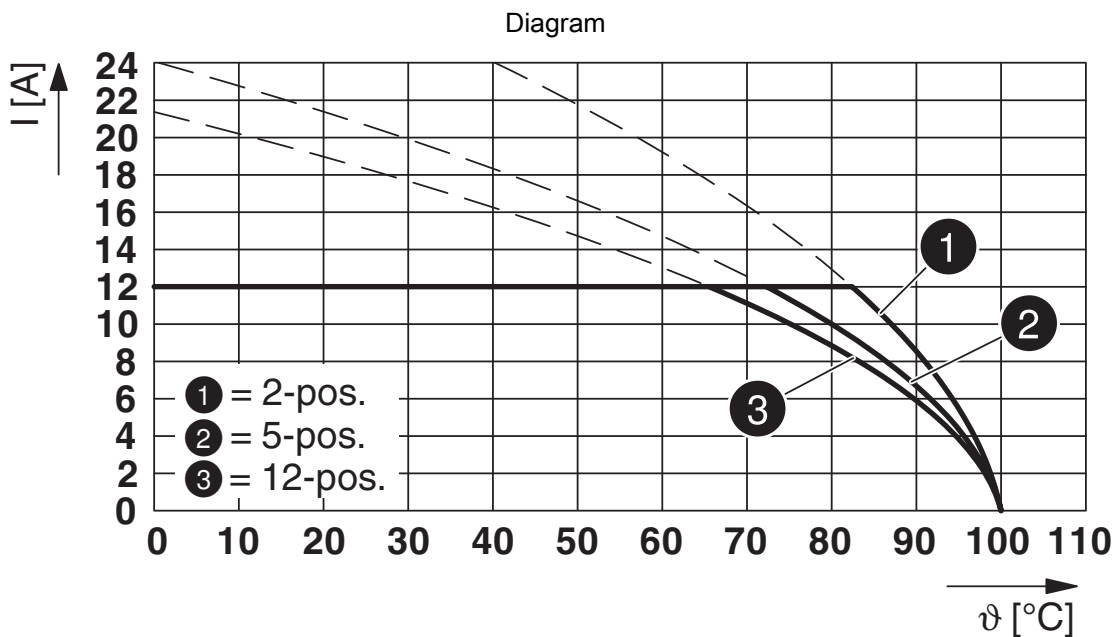

Type: MSTB 2,5/...-STF-5,08 with CCV 2,5/...-GF-5,08-LR P...THR

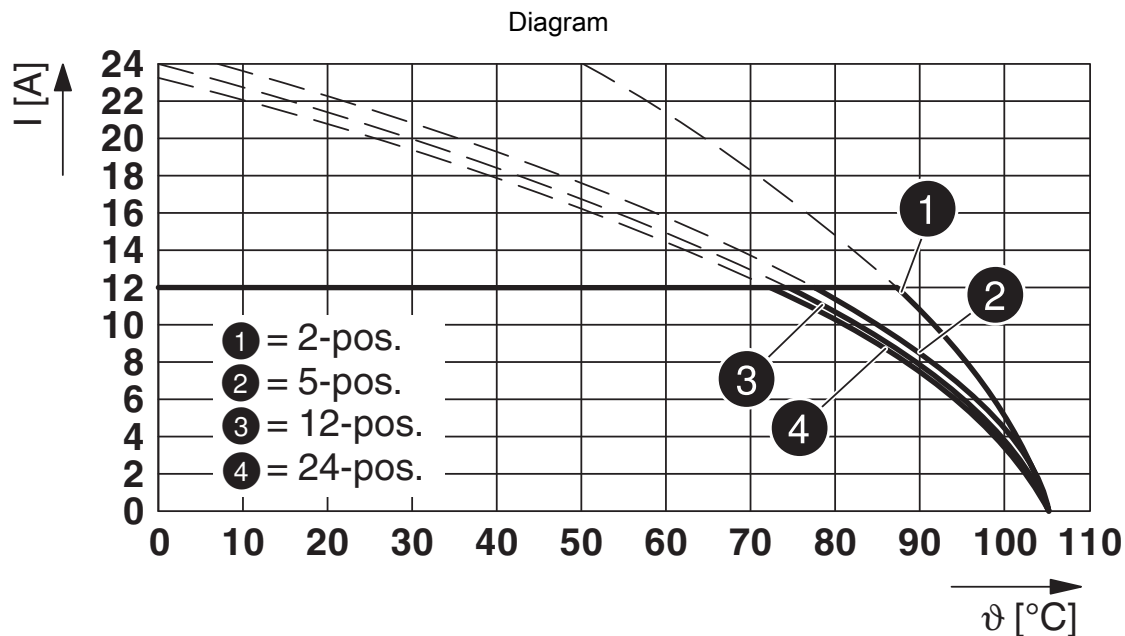

Type: MSTB 2,5/...-STF-5,08 with CC 2,5/...-GF-5,08-LR P...THR

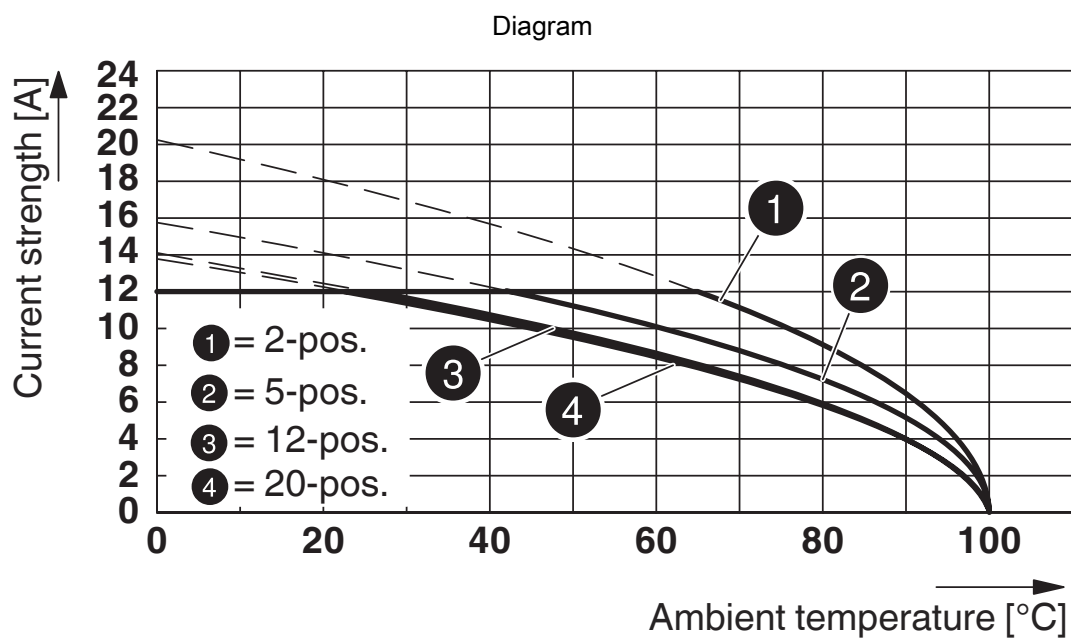

Type: MSTB 2,5/...-STF-5,08 with MSTBV 2,5/...-GF-5,08

PCB connector - MSTB 2,5/ 2-STF-5,08



1777989

<https://www.phoenixcontact.com/de/produkte/1777989>

Approvals

 CSA Approval ID: LR13631-2585950				
	Nominal Voltage U_N	Nominal Current I_N	Cross Section AWG	Cross Section mm^2
Use group B	300 V	15 A	28 - 12	-
Use group D	300 V	10 A	28 - 12	-

 IECEE CB Scheme Approval ID: DE1-60988-B1B2				
	Nominal Voltage U_N	Nominal Current I_N	Cross Section AWG	Cross Section mm^2
	250 V	12 A	-	0.2 - 2.5

 EAC Approval ID: B.01687				
--	--	--	--	--

 cULus Recognized Approval ID: E60425-19931011				
	Nominal Voltage U_N	Nominal Current I_N	Cross Section AWG	Cross Section mm^2
Use group B	300 V	15 A	30 - 12	-
Use group D	300 V	10 A	30 - 12	-

 DNV GL Approval ID: TAE00001EY				
--	--	--	--	--

 RS Approval ID: 17.00014.272				
--	--	--	--	--

 VDE Zeichengenehmigung Approval ID: 40050694				
	Nominal Voltage U_N	Nominal Current I_N	Cross Section AWG	Cross Section mm^2
	250 V	12 A	-	0.2 - 2.5

PCB connector - MSTB 2,5/ 2-STF-5,08



1777989

<https://www.phoenixcontact.com/de/produkte/1777989>

Classifications

ECLASS

ECLASS-9.0	27440309
ECLASS-10.0.1	27440309
ECLASS-11.0	27460202

ETIM

ETIM 8.0	EC002638
----------	----------

UNSPSC

UNSPSC 21.0	39121400
-------------	----------

PCB connector - MSTB 2,5/ 2-STF-5,08



1777989

<https://www.phoenixcontact.com/de/produkte/1777989>

Environmental Product Compliance

REACH SVHC	Lead 7439-92-1
China RoHS	Environmentally Friendly Use Period = 50 years
	For information on hazardous substances, refer to the manufacturer's declaration available under "Downloads"

PCB connector - MSTB 2,5/ 2-STF-5,08

1777989

<https://www.phoenixcontact.com/de/produkte/1777989>

Accessories

 Note: Applying some accessories below might limit this product.

Insertion bridge

Insertion bridge - EBP 2- 5 - 1733169

<https://www.phoenixcontact.com/de/produkte/1733169>

Insertion bridge for connectors with 5.0 mm or 5.08 mm pitch



 Max. current carrying capacity: 24 A

Screwdriver

Screwdriver - SZS 0,6X3,5 - 1205053

<https://www.phoenixcontact.com/de/produkte/1205053>

Actuation tool, for ST terminal blocks, insulated, also suitable for use as a bladed screwdriver, size: 0.6 x 3.5 x 100 mm, 2-component grip, with non-slip grip



PCB connector - MSTB 2,5/ 2-STF-5,08

1777989

<https://www.phoenixcontact.com/de/produkte/1777989>

Marker card

Marker card - SK 5,08/3,8:FORTL.ZAHLEN - 0804293

<https://www.phoenixcontact.com/de/produkte/0804293>



Marker card, white, labeled, horizontal: consecutive numbers 1 ... 10, 11 ... 20, etc. up to 91 ... (99)100, mounting type: adhesive, for terminal block width: 5.08 mm, lettering field size: 5.08 x 3.8 mm

Marker card

Marker card - SK U/3,8 WH:UNBEDRUCKT - 0803906

<https://www.phoenixcontact.com/de/produkte/0803906>



Marker card, Sheet, white, unlabeled, can be labeled with: PLOTMARK, CMS-P1-PLOTTER, Office printing systems, mounting type: adhesive, for terminal block width: 210 mm, lettering field size: 186 x 3.8 mm, Number of individual labels: 1440

PCB connector - MSTB 2,5/ 2-STF-5,08

1777989

<https://www.phoenixcontact.com/de/produkte/1777989>

Marker pen

Marker pen - B-STIFT - 1051993

<https://www.phoenixcontact.com/de/produkte/1051993>



Marker pen, for manual labeling of unprinted Zack strips, smear-proof and waterproof, line thickness 0.5 mm

Marker pen

Marker pen - X-PEN 0,35 - 0811228

<https://www.phoenixcontact.com/de/produkte/0811228>



Marker pen without ink cartridge, for manual labeling of markers, labeling extremely wipe-proof, line thickness 0.35 mm

PCB connector - MSTB 2,5/ 2-STF-5,08

1777989

<https://www.phoenixcontact.com/de/produkte/1777989>

Cable housing

Cable housing - KGG-MSTB 2,5/ 2 - 1803934

<https://www.phoenixcontact.com/de/produkte/1803934>



Cable housing, pitch: 0 mm, number of positions: 2, color: green

PCB header

PCB header - MDSTB 2,5/ 2-GFR-5,08 - 1736768

<https://www.phoenixcontact.com/de/produkte/1736768>



PCB headers, nominal cross section: 2.5 mm², color: green, nominal current: 10 A, rated voltage (III/2): 320 V, contact surface: Tin, type of contact: Male connector, number of potentials: 4, number of rows: 2, number of positions: 2, number of connections: 4, product range: MDSTB 2,5/...-GF, pitch: 5.08 mm, pin layout: Linear pinning, solder pin [P]: 3.2 mm, number of solder pins per potential: 1, plug-in system: COMBICON MSTB 2,5, Pin connector pattern alignment: Standard, locking: Screw locking, mounting: Threaded flange, type of packaging: packed in cardboard, Can be aligned! Mounting flange: Item No. 1736771, 1736768. In combination with MVSTB or FKCV plugs, both an MVSTBW (or FKCVW) and an MVSTBR plug (or FKCVR) must be used. Combination with TMSTBP plugs is not possible!

PCB connector - MSTB 2,5/ 2-STF-5,08

1777989

<https://www.phoenixcontact.com/de/produkte/1777989>

PCB header

PCB header - MDSTB 2,5/ 2-GFL-5,08 - 1736771

<https://www.phoenixcontact.com/de/produkte/1736771>



PCB headers, nominal cross section: 2.5 mm², color: green, nominal current: 10 A, rated voltage (III/2): 320 V, contact surface: Tin, type of contact: Male connector, number of potentials: 4, number of rows: 2, number of positions: 2, number of connections: 4, product range: MDSTB 2,5/...-GF, pitch: 5.08 mm, pin layout: Linear pinning, solder pin [P]: 3.2 mm, number of solder pins per potential: 1, plug-in system: COMBICON MSTB 2,5, Pin connector pattern alignment: Standard, locking: Screw locking, mounting: Threaded flange, type of packaging: packed in cardboard, Can be aligned! Mounting flange: Item No. 1736771, 1736768. In combination with MVSTB or FKCV plugs, both an MVSTBW (or FKCVW) and an MVSTBR plug (or FKCVR) must be used. Combination with TMSTBP plugs is not possible!

PCB header

PCB header - MSTB 2,5/ 2-GF-5,08 - 1776508

<https://www.phoenixcontact.com/de/produkte/1776508>



PCB headers, nominal cross section: 2.5 mm², color: green, nominal current: 12 A, rated voltage (III/2): 320 V, contact surface: Tin, type of contact: Male connector, number of potentials: 2, number of rows: 1, number of positions: 2, number of connections: 2, product range: MSTB 2,5/...-GF, pitch: 5.08 mm, pin layout: Linear pinning, solder pin [P]: 3.5 mm, number of solder pins per potential: 1, plug-in system: COMBICON MSTB 2,5, Pin connector pattern alignment: Standard, locking: Screw locking, type of packaging: packed in cardboard

PCB connector - MSTB 2,5/ 2-STF-5,08

1777989

<https://www.phoenixcontact.com/de/produkte/1777989>

PCB header

PCB header - MSTBV 2,5/ 2-GF-5,08 - 1777073

<https://www.phoenixcontact.com/de/produkte/1777073>

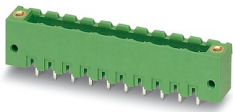

PCB headers, nominal cross section: 2.5 mm², color: green, nominal current: 12 A, rated voltage (III/2): 320 V, contact surface: Tin, type of contact: Male connector, number of potentials: 2, number of rows: 1, number of positions: 2, number of connections: 2, product range: MSTBV 2,5/...-GF, pitch: 5.08 mm, pin layout: Linear pinning, solder pin [P]: 3.9 mm, number of solder pins per potential: 1, plug-in system: COMBICON MSTB 2,5, Pin connector pattern alignment: Standard, locking: Screw locking, mounting: Threaded flange, type of packaging: packed in cardboard

PCB header

PCB header - MDSTBV 2,5/ 2-GFL-5,08 - 1836477

<https://www.phoenixcontact.com/de/produkte/1836477>



PCB headers, nominal cross section: 2.5 mm², color: green, nominal current: 10 A, rated voltage (III/2): 320 V, contact surface: Tin, type of contact: Male connector, number of potentials: 4, number of rows: 2, number of positions: 2, number of connections: 4, product range: MDSTBV 2,5/...-GF, pitch: 5.08 mm, pin layout: Linear pinning, solder pin [P]: 3.9 mm, number of solder pins per potential: 1, plug-in system: COMBICON MSTB 2,5, Pin connector pattern alignment: Standard, locking: Screw locking, mounting: Threaded flange, type of packaging: packed in cardboard, The article can be aligned to create different nos. of positions! In combination with MVSTB or FKCV plug components, both an MVSTBW (or FKCVW) and an MVSTBR plug (or FKCVR) must be used. Combination with TMSTBP plug components is not possible!

PCB connector - MSTB 2,5/ 2-STF-5,08

1777989

<https://www.phoenixcontact.com/de/produkte/1777989>

PCB header

PCB header - MDSTBV 2,5/ 2-GFR-5,08 - 1836480

<https://www.phoenixcontact.com/de/produkte/1836480>



PCB headers, nominal cross section: 2.5 mm², color: green, nominal current: 10 A, rated voltage (III/2): 320 V, contact surface: Tin, type of contact: Male connector, number of potentials: 4, number of rows: 2, number of positions: 2, number of connections: 4, product range: MDSTBV 2,5/...-GF, pitch: 5.08 mm, pin layout: Linear pinning, solder pin [P]: 3.9 mm, number of solder pins per potential: 1, plug-in system: COMBICON MSTB 2,5, Pin connector pattern alignment: Standard, locking: Screw locking, mounting: Threaded flange, type of packaging: packed in cardboard, The article can be aligned to create different nos. of positions! In combination with MVSTB or FKCV plug components, both an MVSTBW (or FKCVW) and an MVSTBR plug (or FKCVR) must be used. Combination with TMSTBP plug components is not possible!

PCB header

PCB header - MDSTB 2,5/ 2-GF-5,08 - 1842364

<https://www.phoenixcontact.com/de/produkte/1842364>

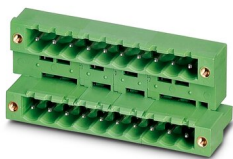

PCB headers, nominal cross section: 2.5 mm², color: green, nominal current: 10 A, rated voltage (III/2): 320 V, contact surface: Tin, type of contact: Male connector, number of potentials: 4, number of rows: 2, number of positions: 2, number of connections: 4, product range: MDSTB 2,5/...-GF, pitch: 5.08 mm, pin layout: Linear pinning, solder pin [P]: 3.2 mm, number of solder pins per potential: 1, plug-in system: COMBICON MSTB 2,5, Pin connector pattern alignment: Standard, locking: Screw locking, mounting: Threaded flange, type of packaging: packed in cardboard, The article can be aligned to create different nos. of positions! In combination with MVSTB or FKCV plug components, both an MVSTBW (or FKCVW) and an MVSTBR plug (or FKCVR) must be used. Combination with TMSTBP plug components is not possible!

PCB connector - MSTB 2,5/ 2-STF-5,08

1777989

<https://www.phoenixcontact.com/de/produkte/1777989>

PCB header

PCB header - MDSTBV 2,5/ 2-GF-5,08 - 1845633

<https://www.phoenixcontact.com/de/produkte/1845633>

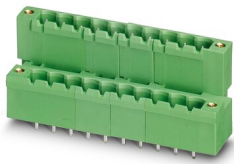

PCB headers, nominal cross section: 2.5 mm², color: green, nominal current: 10 A, rated voltage (III/2): 320 V, contact surface: Tin, type of contact: Male connector, number of potentials: 4, number of rows: 2, number of positions: 2, number of connections: 4, product range: MDSTBV 2,5/...-GF, pitch: 5.08 mm, pin layout: Linear pinning, solder pin [P]: 3.9 mm, number of solder pins per potential: 1, plug-in system: COMBICON MSTB 2,5, Pin connector pattern alignment: Standard, locking: Screw locking, mounting: Threaded flange, type of packaging: packed in cardboard. The article can be aligned to create different nos. of positions! In combination with MVSTB or FKCV plug components, both an MVSTBW (or FKCVW) and an MVSTBR plug (or FKCVR) must be used. Combination with TMSTBP plug components is not possible!

Feed-through header

Feed-through header - DFK-MSTBA 2,5/ 2-GF-5,08 - 1898981

<https://www.phoenixcontact.com/de/produkte/1898981>



Feed-through header, nominal cross section: 2.5 mm², color: green, nominal current: 12 A, rated voltage (III/2): 320 V, contact surface: Tin, type of contact: Male connector, number of potentials: 2, number of rows: 1, number of positions: 2, number of connections: 2, product range: DFK-MSTBA 2,5/...-GF, pitch: 5.08 mm, pin layout: Linear pinning, solder pin [P]: 3.2 mm, number of solder pins per potential: 1, plug-in system: COMBICON MSTB 2,5, Pin connector pattern alignment: Standard, locking: Screw locking, mounting: Threaded flange, type of packaging: packed in cardboard

PCB connector - MSTB 2,5/ 2-STF-5,08

1777989

<https://www.phoenixcontact.com/de/produkte/1777989>

Feed-through header

Feed-through header - DFK-MSTBVA 2,5/ 2-GF-5,08 - 1899281

<https://www.phoenixcontact.com/de/produkte/1899281>



Feed-through header, nominal cross section: 2.5 mm², color: green, nominal current: 12 A, rated voltage (III/2): 320 V, contact surface: Tin, type of contact: Male connector, number of potentials: 2, number of rows: 1, number of positions: 2, number of connections: 2, product range: DFK-MSTBVA 2,5/...-GF, pitch: 5.08 mm, pin layout: Linear pinning, solder pin [P]: 3.9 mm, number of solder pins per potential: 1, plug-in system: COMBICON MSTB 2,5, Pin connector pattern alignment: Standard, locking: Screw locking, mounting: Threaded flange, type of packaging: packed in cardboard

PCB header

PCB header - CC 2,5/ 2-GF-5,08 P26THR - 1954692

<https://www.phoenixcontact.com/de/produkte/1954692>



PCB headers, nominal cross section: 2.5 mm², color: black, nominal current: 12 A, rated voltage (III/2): 320 V, contact surface: Tin, type of contact: Male connector, number of potentials: 2, number of rows: 1, number of positions: 2, number of connections: 2, product range: CC 2,5/...-GF, pitch: 5.08 mm, pin layout: Linear pinning, solder pin [P]: 2.6 mm, number of solder pins per potential: 1, plug-in system: COMBICON MSTB 2,5, Pin connector pattern alignment: Standard, locking: Screw locking, mounting: Threaded flange, type of packaging: packed in cardboard, For user information and design recommendations for through-hole reflow technology, go to: Downloads

PCB connector - MSTB 2,5/ 2-STF-5,08

1777989

<https://www.phoenixcontact.com/de/produkte/1777989>

PCB header

PCB header - CC 2,5/ 2-GF-5,08 P26THRR32 - 1954809

<https://www.phoenixcontact.com/de/produkte/1954809>



PCB headers, nominal cross section: 2.5 mm², color: black, nominal current: 12 A, rated voltage (III/2): 320 V, contact surface: Tin, type of contact: Male connector, number of potentials: 2, number of rows: 1, number of positions: 2, number of connections: 2, product range: CC 2,5/...-GF, pitch: 5.08 mm, pin layout: Linear pinning, solder pin [P]: 2.6 mm, number of solder pins per potential: 1, plug-in system: COMBICON MSTB 2,5, Pin connector pattern alignment: Standard, locking: Screw locking, mounting: Threaded flange, type of packaging: 32 mm wide tape, For user information and design recommendations for through-hole reflow technology, go to: Downloads

PCB header

PCB header - CCV 2,5/ 2-GF-5,08 P26THR - 1955633

<https://www.phoenixcontact.com/de/produkte/1955633>



PCB headers, nominal cross section: 2.5 mm², color: black, nominal current: 12 A, rated voltage (III/2): 320 V, contact surface: Tin, type of contact: Male connector, number of potentials: 2, number of rows: 1, number of positions: 2, number of connections: 2, product range: CCV 2,5/...-GF, pitch: 5.08 mm, pin layout: Linear pinning, solder pin [P]: 2.6 mm, number of solder pins per potential: 1, plug-in system: COMBICON MSTB 2,5, Pin connector pattern alignment: Standard, locking: Screw locking, mounting: Threaded flange, type of packaging: packed in cardboard, For user information and design recommendations for through-hole reflow technology, go to: Downloads

PCB connector - MSTB 2,5/ 2-STF-5,08



1777989

<https://www.phoenixcontact.com/de/produkte/1777989>

PCB header

PCB header - CCV 2,5/ 2-GF-5,08 P26THRR32 - 1955743

<https://www.phoenixcontact.com/de/produkte/1955743>



PCB headers, nominal cross section: 2.5 mm², color: black, nominal current: 12 A, rated voltage (III/2): 320 V, contact surface: Tin, type of contact: Male connector, number of potentials: 2, number of rows: 1, number of positions: 2, number of connections: 2, product range: CCV 2,5/..-GF, pitch: 5.08 mm, pin layout: Linear pinning, solder pin [P]: 2.6 mm, number of solder pins per potential: 1, plug-in system: COMBICON MSTB 2,5, Pin connector pattern alignment: Standard, locking: Screw locking, mounting: Threaded flange, type of packaging: 32 mm wide tape, For user information and design recommendations for through-hole reflow technology, go to: Downloads

Phoenix Contact 2022 © - all rights reserved

<https://www.phoenixcontact.com>

PHOENIX CONTACT Deutschland GmbH

Flachsmarktstraße 8

D-32825 Blomberg

+49 52 35/3-1 20 00

info@phoenixcontact.de