

# Single relay - REL-IR4/L-230AC/4X21



2903688

<https://www.phoenixcontact.com/de/produkte/2903688>

Please be informed that the data shown in this PDF document is generated from our Online Catalog. Please find the complete data in the user documentation. Our General Terms of Use for Downloads are valid.

---



Plug-in industrial relay with power contacts, 4 changeover contacts, test button, status LED, mechanical switching position indicator, input voltage: 230 V AC

---

# Single relay - REL-IR4/L-230AC/4X21



2903688

<https://www.phoenixcontact.com/de/produkte/2903688>

## Commercial Data

Item number	2903688
Packing unit	10 pc
Minimum order quantity	10 pc
Note	Made to Order (non-returnable)
Sales Key	G1 - Relais
Product Key	CK6193
Catalog Page	Page 300 (C-5-2019)
GTIN	4046356759014
Weight per Piece (including packing)	31,984 g
Weight per Piece (excluding packing)	30,9 g
Customs tariff number	85364900
Country of origin	PL

# Single relay - REL-IR4/L-230AC/4X21



2903688

<https://www.phoenixcontact.com/de/produkte/2903688>

## Technical Data

### Product properties

Product type	Single relay
Set comprises	2903304 RIF-2-RPT-LV-230AC/4X21
	2903316 RIF-2-RSC-LV-230AC/4X21
Operating mode	100% operating factor
Mechanical service life	approx. $2 \times 10^7$ cycles

### Insulation characteristics

Overvoltage category	II
Pollution degree	2
Insulation	Basic insulation

### Electrical properties

Service life electrical	see diagram
Maximum power dissipation for nominal condition	1.5 W
Test voltage	2.5 kV <sub>rms</sub> (50 Hz, 1 min., winding/contact)
Test voltage Changeover contact/changeover contact	2 kV <sub>rms</sub> (50 Hz, 1 min., changeover contact/changeover contact)
Rated insulation voltage	250 V AC
Rated surge voltage	2.5 kV

### Input data

#### Coil side

Nominal input voltage $U_N$	230 V AC
Input voltage range	179.4 V AC ... 317.4 V AC (20 °C)
Mains frequency	50/60 Hz
Typical input current at $U_N$	6.5 mA
Typical response time	5 ms ... 15 ms (depending on phase relation)
Typical release time range	5 ms ... 20 ms (depending on phase relation)
Status display	Yellow LED

### Output data

#### Switching

Contact type	4 changeover contacts
Type of switch contact	Single contact
Drive and function	monostable
Drive (polarity)	bipolar
Contact material	AgNi
Maximum switching voltage	250 V AC/DC
Minimum switching voltage	5 V (At 24 mA)
Limiting continuous current	6 A
Maximum inrush current	16 A (20 ms, N/O contacts)

# Single relay - REL-IR4/L-230AC/4X21



2903688

<https://www.phoenixcontact.com/de/produkte/2903688>

Min. switching current	5 mA (at 24 V)
Interrupting rating (ohmic load) max.	144 W (at 24 V DC)
	124 W (at 48 V DC)
	108 W (at 60 V DC)
	52 W (at 110 V DC)
	48 W (at 220 V DC)
	1500 VA (for 250 V AC)
Switching capacity min.	0.12 W
Switching capacity	2 A (at 24 V, DC13)
	0.22 A (at 120 V, DC13)
	0.11 A (at 250 V, DC13)
	1.5 A (at 24 V, AC15)
	1.5 A (at 120 V, AC15)
	1 A (at 240 V, AC15)

## Connection data

Connection method	Plug-in connection
-------------------	--------------------

## Dimensions

Width	21.2 mm
Height	27.5 mm
Depth	35.6 mm

## Environmental and real-life conditions

### Ambient conditions

Degree of protection	RT I
Ambient temperature (operation)	-40 °C ... 55 °C
Ambient temperature (storage/transport)	-40 °C ... 85 °C

## Approval data

### Corrosive gas test

Identification	ISA-S71.04. G3 Harsh Group
	EN 60068-2-60

## Standards and regulations

Standards/regulations	IEC 60664
	IEC 61810

## Mounting

Mounting position	any
-------------------	-----

# Single relay - REL-IR4/L-230AC/4X21

2903688

<https://www.phoenixcontact.com/de/produkte/2903688>

## Drawings

Diagram

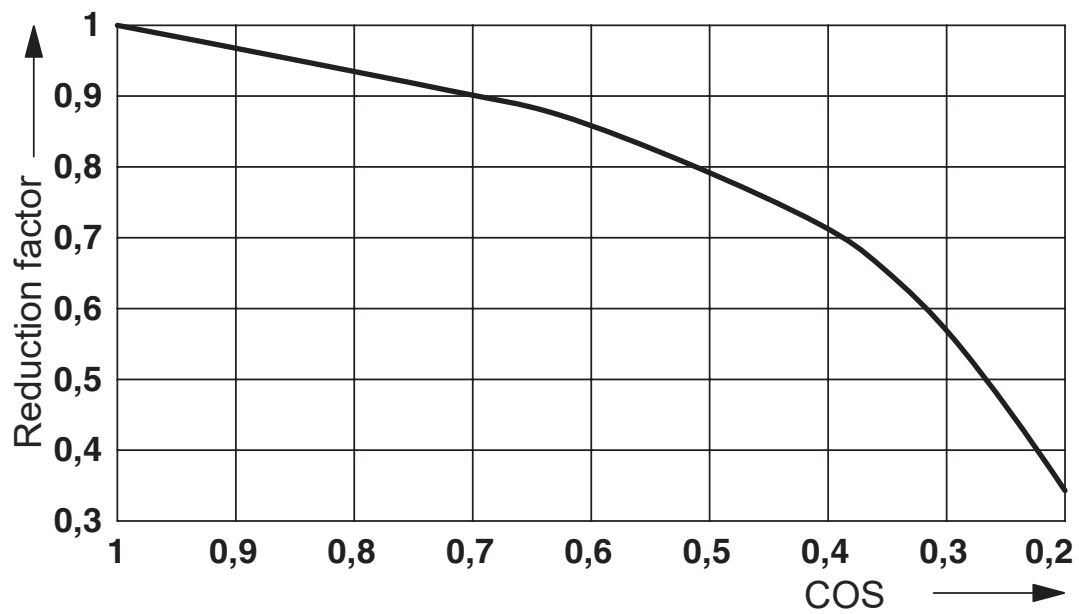

Service life reduction factor

Circuit diagram

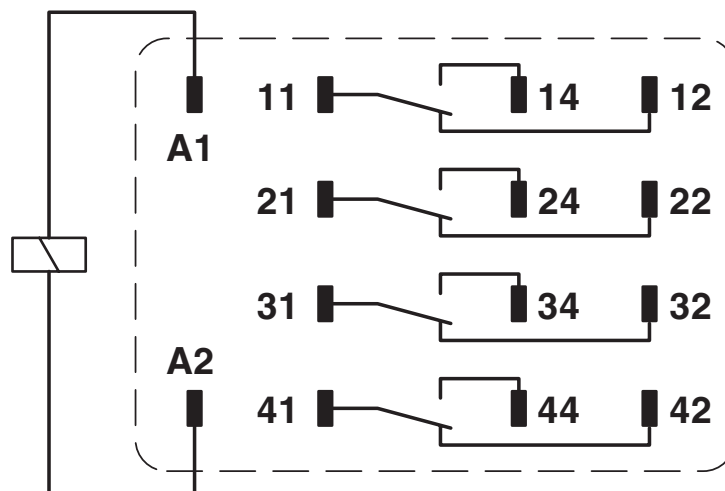

# Single relay - REL-IR4/L-230AC/4X21

2903688

<https://www.phoenixcontact.com/de/produkte/2903688>

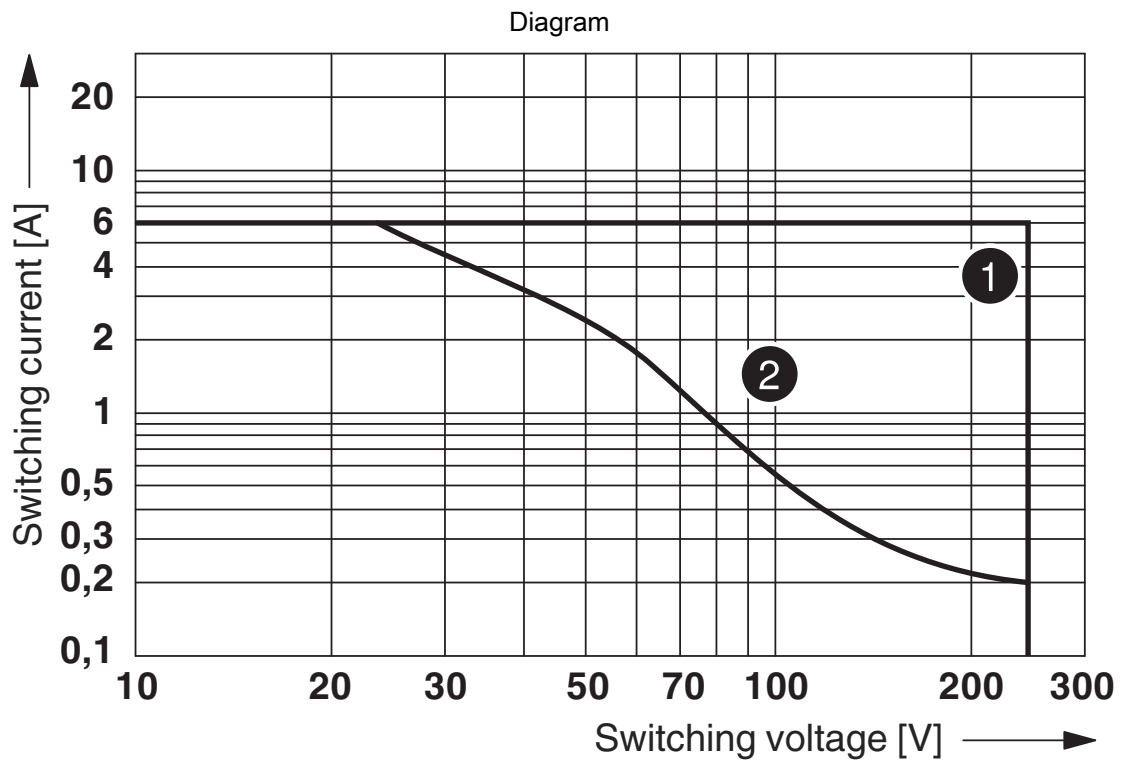

① AC, ohmic load

② DC, ohmic load

Interrupting rating

# Single relay - REL-IR4/L-230AC/4X21

2903688

<https://www.phoenixcontact.com/de/produkte/2903688>

Diagram

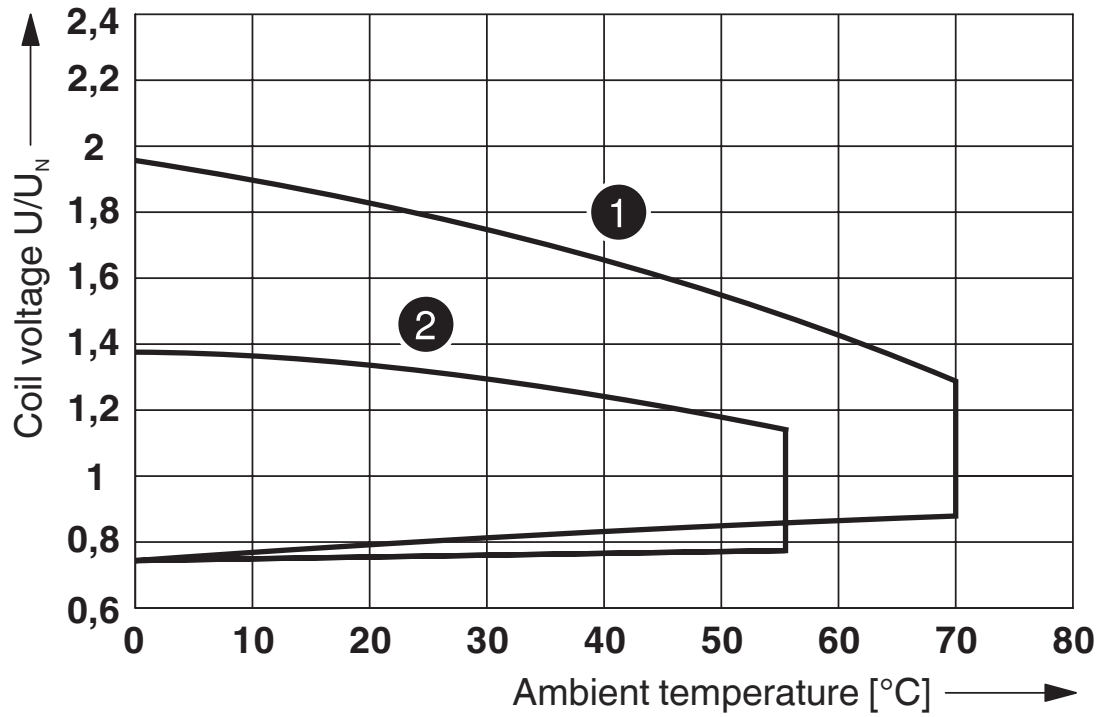

① DC coils

② AC coils

Operating voltage range

# Single relay - REL-IR4/L-230AC/4X21

2903688

<https://www.phoenixcontact.com/de/produkte/2903688>

Diagram

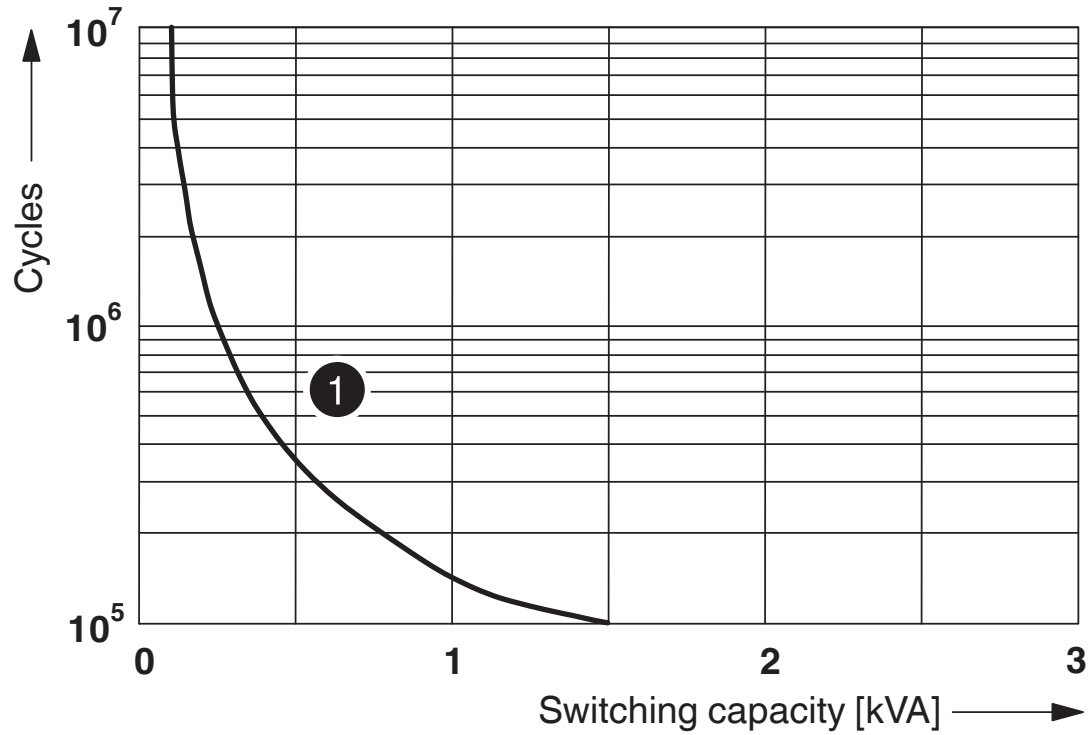

① 250 V AC, Ohmic load

Electrical service life



# Single relay - REL-IR4/L-230AC/4X21



2903688

<https://www.phoenixcontact.com/de/produkte/2903688>

## Approvals

 **CSA**  
Approval ID: 2554095

 **cUL Recognized**  
Approval ID: FILE E 172140

 **UL Recognized**  
Approval ID: FILE E 172140

 **EAC**  
Approval ID: TR\_TS\_D\_00573\_c

 **EAC**  
Approval ID: RU\*C-DE.\*08.B.00010

 **VDE Zeichengenehmigung**  
Approval ID: 40040427

**cULus Recognized**

# Single relay - REL-IR4/L-230AC/4X21



2903688

<https://www.phoenixcontact.com/de/produkte/2903688>

## Classifications

### ECLASS

ECLASS-9.0	27371601
ECLASS-10.0.1	27371601
ECLASS-11.0	27371601

### ETIM

ETIM 8.0	EC001437
----------	----------

### UNSPSC

UNSPSC 21.0	39122300
-------------	----------

# Single relay - REL-IR4/L-230AC/4X21



2903688

<https://www.phoenixcontact.com/de/produkte/2903688>

## Environmental Product Compliance

China RoHS	Environmentally friendly use period: unlimited = EFUP-e
	No hazardous substances above threshold values

# Single relay - REL-IR4/L-230AC/4X21

2903688

<https://www.phoenixcontact.com/de/produkte/2903688>



## Accessories

### Relay base

Relay base - RIF-2-BPT/4X21 - 2900934

<https://www.phoenixcontact.com/de/produkte/2900934>



Relay base RIF-2..., for industrial relay with 2 or 4 changeover contacts, Push-in connection, plug-in option for input/interference suppression modules, for mounting on NS 35/7,5

### Relay base

Relay base - RIF-2-BSC/4X21 - 2900932

<https://www.phoenixcontact.com/de/produkte/2900932>



RIF-2... relay base, for industrial relay with 2 or 4 changeover contacts, screw connection, plug-in option for input/interference suppression modules, for mounting on NS 35/7,5

Phoenix Contact 2022 © - all rights reserved

<https://www.phoenixcontact.com>

PHOENIX CONTACT Deutschland GmbH

Flachsmarktstraße 8

D-32825 Blomberg

+49 52 35/3-1 20 00

[info@phoenixcontact.de](mailto:info@phoenixcontact.de)