

Plug - UP 4/ 1-R

3060089

<https://www.phoenixcontact.com/pc/products/3060089>



Please be informed that the data shown in this PDF document is generated from our Online Catalog. Please find the complete data in the user documentation. Our General Terms of Use for Downloads are valid.



Plug, nom. voltage: 800 V, nominal current: 32 A, number of positions: 1, connection method: Screw connection, Rated cross section: 4 mm², cross section: 0.2 mm²- 6 mm², color: gray

Product Description

Connector element right, left housing with engagement pin, right closed with cover

Your advantages

- The screw plugs can be combined with COMBI terminal blocks with all forms of connection technology and are available in two versions
- The COMBI plugs for self-assembly provide solutions that users can implement themselves
- The plugs are assembled directly on site by snapping together single-position plug elements
- The plug design enables space-saving potential distribution by using four-conductor terminal blocks with two slots

Plug - UP 4/ 1-R

3060089

<https://www.phoenixcontact.com/pc/products/3060089>



Commercial Data

Item number	3060089
Packing unit	50 pc
Minimum order quantity	1 pc
Note	Made to Order (non-returnable)
Product Key	BE1144
Catalog Page	Page 336 (C-1-2019)
GTIN	4046356090209
Weight per Piece (including packing)	5.24 g
Weight per Piece (excluding packing)	5.2 g
Customs tariff number	85366990
Country of origin	TR

Plug - UP 4/ 1-R

3060089

<https://www.phoenixcontact.com/pc/products/3060089>



Technical Data

Product properties

Product type	Terminal plug
Number of positions	1
Pitch	6.2 mm
Potentials	1

Insulation characteristics

Overvoltage category	III
Degree of pollution	3

Electrical properties

Rated surge voltage	8 kV
---------------------	------

Connection data

Nominal cross section	4 mm ²
Screw thread	M3
Tightening torque	0.6 ... 0.8 Nm
Stripping length	9 mm
Internal cylindrical gage	A4
Conductor cross section solid	0.2 mm ² ... 6 mm ²
Cross section AWG	24 ... 10
Conductor cross section flexible	0.2 mm ² ... 6 mm ²
Conductor cross section, flexible [AWG]	24 ... 10
Flexible conductor cross section flexible (ferrule, w/o plastic sleeve)	0.25 mm ² ... 4 mm ²
Flexible conductor cross section (ferrule with plastic sleeve)	0.25 mm ² ... 4 mm ²
2 conductors with same cross section, solid	0.2 mm ² ... 1.5 mm ²
2 conductors with same cross section, flexible	0.2 mm ² ... 1.5 mm ²
2 conductors with same cross section, flexible, with ferrule without plastic sleeve	0.25 mm ² ... 1.5 mm ²
2 conductors with the same cross section, flexible, with TWIN ferrule with plastic sleeve	0.5 mm ² ... 1.5 mm ²
Nominal current	32 A
Maximum load current	32 A (with 6 mm ² conductor cross section)
Nominal voltage	800 V
Nominal cross section	4 mm ²

Dimensions

Width	6.2 mm
Height	41.2 mm
Length	21 mm
Pitch	6.2 mm

Plug - UP 4/ 1-R



3060089

<https://www.phoenixcontact.com/pc/products/3060089>

Material specifications

Color	gray
Flammability rating according to UL 94	V0
Insulating material group	I
Insulating material	PA
Static insulating material application in cold	-60 °C
Temperature index of insulation material (DIN EN 60216-1 (VDE 0304-21))	125 °C
Relative insulation material temperature index (Elec., UL 746 B)	130 °C
Fire protection for rail vehicles (DIN EN 45545-2) R22	HL 1 - HL 3
Fire protection for rail vehicles (DIN EN 45545-2) R23	HL 1 - HL 3
Fire protection for rail vehicles (DIN EN 45545-2) R24	HL 1 - HL 3
Fire protection for rail vehicles (DIN EN 45545-2) R26	HL 1 - HL 3
Calorimetric heat release NFPA 130 (ASTM E 1354)	27,5 MJ/kg
Surface flammability NFPA 130 (ASTM E 162)	passed
Specific optical density of smoke NFPA 130 (ASTM E 662)	passed
Smoke gas toxicity NFPA 130 (SMP 800C)	passed

Connector

Number of positions	1
Number of positions	1

Environmental and real-life conditions

Ambient conditions

Ambient temperature (operation)	-60 °C ... 105 °C (max. short-term operating temperature RTI Elec.)
Ambient temperature (storage/transport)	-25 °C ... 60 °C (for a short time, not exceeding 24 h, -60 °C to +70 °C)
Ambient temperature (assembly)	-5 °C ... 70 °C
Ambient temperature (actuation)	-5 °C ... 70 °C
Permissible humidity (storage/transport)	30 % ... 70 %

Standards and regulations

Connection in acc. with standard	IEC 61984
----------------------------------	-----------

Drawings

Diagram

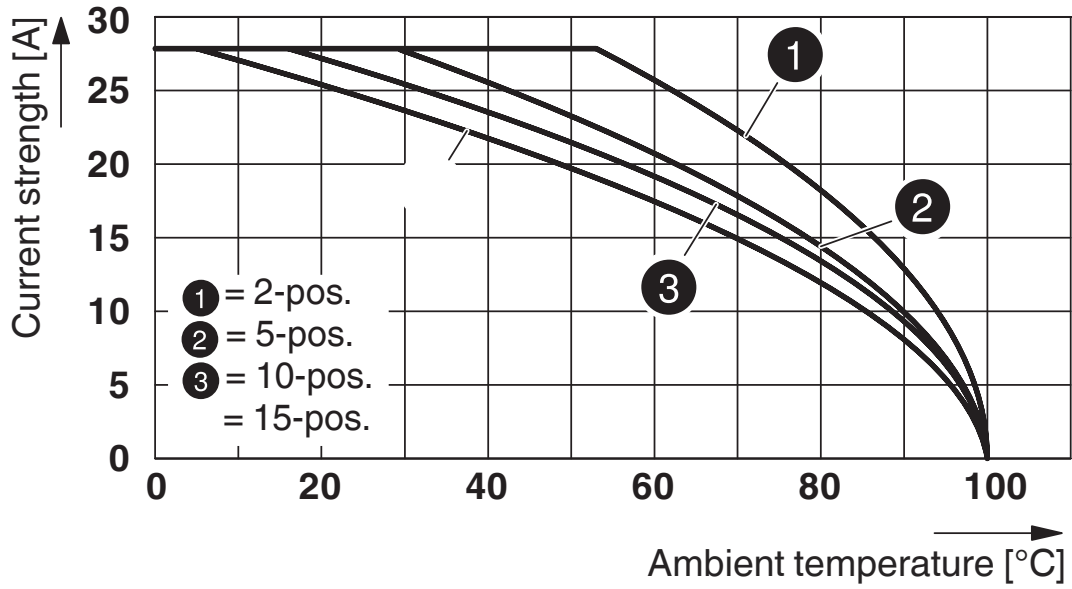

Circuit diagram



Plug - UP 4/ 1-R

3060089

<https://www.phoenixcontact.com/pc/products/3060089>



Schematic diagram

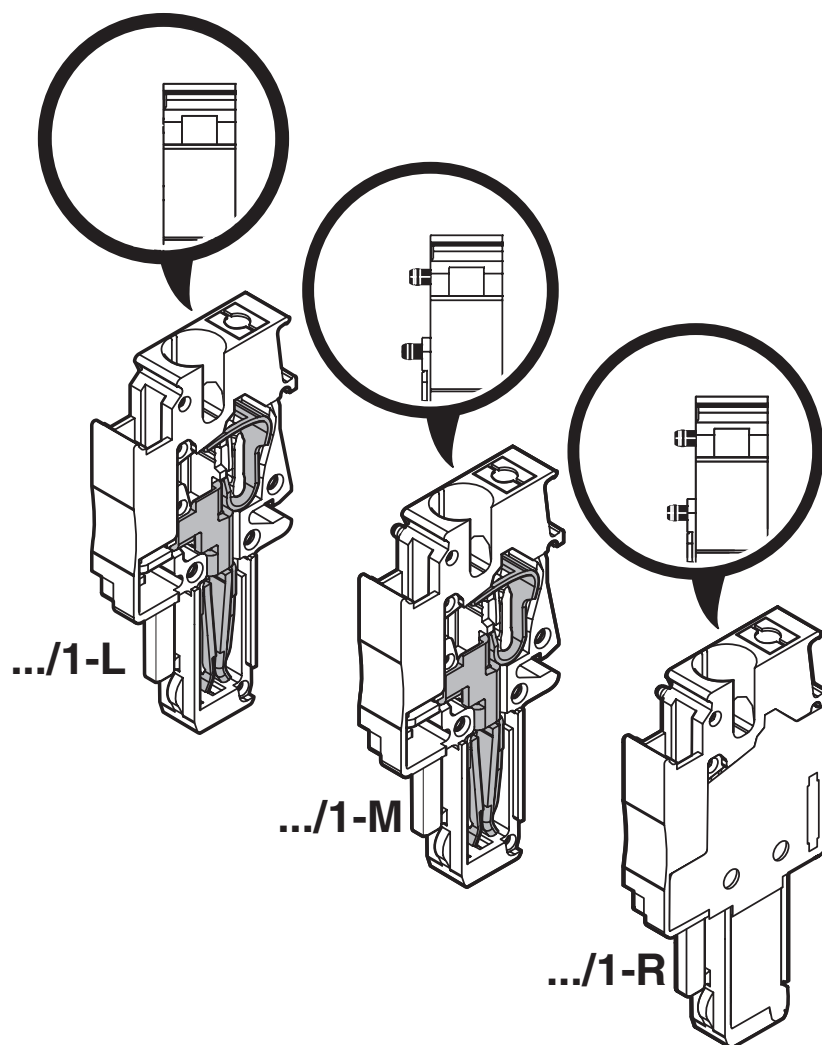

Plug - UP 4/ 1-R





3060089

<https://www.phoenixcontact.com/pc/products/3060089>

Approvals

 CSA				
	Nominal Voltage U_N	Nominal Current I_N	Cross Section AWG	Cross Section mm^2
Use group B				
	600 V	30 A	26 - 10	-
Use group C				
	600 V	30 A	26 - 10	-

 IECEE CB Scheme				
	Nominal Voltage U_N	Nominal Current I_N	Cross Section AWG	Cross Section mm^2
	800 V	32 A	-	-

 EAC				
---	--	--	--	--

 cULus Recognized				
	Nominal Voltage U_N	Nominal Current I_N	Cross Section AWG	Cross Section mm^2
Use group B				
	600 V	30 A	26 - 10	-
Multi-conductor connection	600 V	30 A	26 - 14	-
Use group C				
	600 V	30 A	26 - 10	-
Multi-conductor connection	600 V	30 A	26 - 14	-

 KEMA-KEUR				
	Nominal Voltage U_N	Nominal Current I_N	Cross Section AWG	Cross Section mm^2
	800 V	32 A	-	-

Plug - UP 4/ 1-R

3060089

<https://www.phoenixcontact.com/pc/products/3060089>



Classifications

ECLASS

ECLASS-9.0	27141151
ECLASS-10.0.1	27141151
ECLASS-11.0	27141151

ETIM

ETIM 8.0	EC002021
----------	----------

UNSPSC

UNSPSC 21.0	39121400
-------------	----------

Plug - UP 4/ 1-R

3060089

<https://www.phoenixcontact.com/pc/products/3060089>



Environmental Product Compliance

China RoHS	Environmentally Friendly Use Period = 50 years For information on hazardous substances, refer to the manufacturer's declaration available under "Downloads"
------------	--

Plug - UP 4/ 1-R

3060089

<https://www.phoenixcontact.com/pc/products/3060089>



Accessories

Screwdriver

Screwdriver - SZS 0,6X3,5 - 1205053

<https://www.phoenixcontact.com/pc/products/1205053>



Actuation tool, for ST terminal blocks, insulated, also suitable for use as a bladed screwdriver, size: 0.6 x 3.5 x 100 mm, 2-component grip, with non-slip grip

Screwdriver

Screwdriver - SF-SL 0,6X3,5-100 S-VDE - 1212587

<https://www.phoenixcontact.com/pc/products/1212587>



Actuation tool, for ST terminal blocks, VDE insulated, with slimmer insulation integrated in the blade, also suitable for use as a bladed screwdriver, size: 0.6 x 3.5 x 100 mm, 2-component grip, with non-slip grip

Plug - UP 4/ 1-R

3060089

<https://www.phoenixcontact.com/pc/products/3060089>



Flange cover

Flange cover - DF-UP 4 - 3060348

<https://www.phoenixcontact.com/pc/products/3060348>

Flange cover, snap onto the UP 4/... plugs, length: 47 mm, width: 4.5 mm, height: 24.7 mm, color: gray



Zack Marker strip, flat

Zack Marker strip, flat - ZBF 6:UNBEDRUCKT - 0808710

<https://www.phoenixcontact.com/pc/products/0808710>

Zack Marker strip, flat, Strip, white, unlabeled, can be labeled with: PLOTMARK, CMS-P1-PLOTTER, mounting type: snap in, for terminal block width: 6.2 mm, lettering field size: 5.15 x 6.15 mm, Number of individual labels: 10



Plug - UP 4/ 1-R

3060089

<https://www.phoenixcontact.com/pc/products/3060089>



Zack Marker strip, flat

Zack Marker strip, flat - ZBF 6 CUS - 0825027

<https://www.phoenixcontact.com/pc/products/0825027>



Zack Marker strip, flat, Strip, can be ordered: Strip, white, labeled according to customer specifications, mounting type: snap into flat marker groove, for terminal block width: 6.2 mm, lettering field size: 5.15 x 6.15 mm, Number of individual labels: 10

Zack Marker strip, flat

Zack Marker strip, flat - ZBF 6,LGS:FORTL.ZAHLEN - 0808749

<https://www.phoenixcontact.com/pc/products/0808749>



Zack Marker strip, flat, Strip, white, labeled, printed horizontally: consecutive numbers 1 ... 10, 11 ... 20, etc. up to 91 ... 100, mounting type: snap into flat marker groove, for terminal block width: 6.2 mm, lettering field size: 5.15 x 6.15 mm, Number of individual labels: 10

Plug - UP 4/ 1-R

3060089

<https://www.phoenixcontact.com/pc/products/3060089>



Zack Marker strip, flat

Zack Marker strip, flat - ZBF 6,QR:FORTL.ZAHLEN - 0808765

<https://www.phoenixcontact.com/pc/products/0808765>



Zack Marker strip, flat, Strip, white, labeled, Printed vertically: consecutive numbers 1 ... 10, 11 ... 20, etc. up to 91 ... 100, mounting type: snap into flat marker groove, for terminal block width: 6.2 mm, lettering field size: 5.15 x 6.15 mm, Number of individual labels: 10

Zack Marker strip, flat

Zack Marker strip, flat - ZBF 6,LGS:GERADE ZAHLEN - 0810834

<https://www.phoenixcontact.com/pc/products/0810834>



Zack Marker strip, flat, Strip, white, labeled, printed horizontally: consecutive even numbers 2 ... 20, 22 ... 40, etc. up to 82 ... 100, mounting type: snap into flat marker groove, for terminal block width: 6.2 mm, lettering field size: 5.15 x 6.15 mm, Number of individual labels: 10

Plug - UP 4/ 1-R

3060089

<https://www.phoenixcontact.com/pc/products/3060089>



Zack Marker strip, flat

Zack Marker strip, flat - ZBF 6,LGS:UNGERADE ZAHLEN - 0810876

<https://www.phoenixcontact.com/pc/products/0810876>

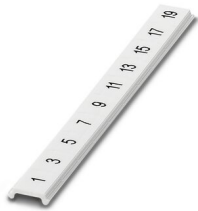

Zack Marker strip, flat, Strip, white, labeled, printed horizontally: Odd numbers 1 - 19, 21 - 39, etc. up to 81 - 99, mounting type: snap into flat marker groove, for terminal block width: 6.2 mm, lettering field size: 5.15 x 6.15 mm, Number of individual labels: 10

Latching

Latching - PRZ - 3040614

<https://www.phoenixcontact.com/pc/products/3040614>



Latching, color: orange

Plug - UP 4/ 1-R

3060089

<https://www.phoenixcontact.com/pc/products/3060089>



Latching

Latching - PR - 3040559

<https://www.phoenixcontact.com/pc/products/3040559>



Latching, length: 29.8 mm, width: 4.4 mm, number of positions: 1, color: orange

Latching

Latching - PR/2 - 3040630

<https://www.phoenixcontact.com/pc/products/3040630>



Latching, length: 29.8 mm, width: 10 mm, number of positions: 2, color: orange

Plug - UP 4/ 1-R

3060089

<https://www.phoenixcontact.com/pc/products/3060089>



Latching

Latching - PRT/2 - 3040631

<https://www.phoenixcontact.com/pc/products/3040631>



Latching, can only be released using a screwdriver, length: 23.2 mm, width: 9 mm, number of positions: 2, color: orange

Strain relief

Strain relief - PZ/2 - 3040627

<https://www.phoenixcontact.com/pc/products/3040627>



Strain relief, length: 48.7 mm, width: 9.3 mm, number of positions: 2, color: black

Plug - UP 4/ 1-R

3060089

<https://www.phoenixcontact.com/pc/products/3060089>



Insulating sleeve

Insulating sleeve - MPS-IH WH - 0201663

<https://www.phoenixcontact.com/pc/products/0201663>

Insulating sleeve, color: white



Insulating sleeve

Insulating sleeve - MPS-IH RD - 0201676

<https://www.phoenixcontact.com/pc/products/0201676>

Insulating sleeve, color: red



Plug - UP 4/ 1-R

3060089

<https://www.phoenixcontact.com/pc/products/3060089>



Insulating sleeve

Insulating sleeve - MPS-IH BU - 0201689

<https://www.phoenixcontact.com/pc/products/0201689>

Insulating sleeve, color: blue

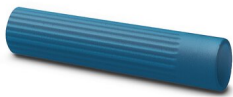

Insulating sleeve

Insulating sleeve - MPS-IH YE - 0201692

<https://www.phoenixcontact.com/pc/products/0201692>

Insulating sleeve, color: yellow



Plug - UP 4/ 1-R

3060089

<https://www.phoenixcontact.com/pc/products/3060089>



Insulating sleeve

Insulating sleeve - MPS-IH GN - 0201702

<https://www.phoenixcontact.com/pc/products/0201702>

Insulating sleeve, color: green



Insulating sleeve

Insulating sleeve - MPS-IH GY - 0201728

<https://www.phoenixcontact.com/pc/products/0201728>

Insulating sleeve, color: gray



Plug - UP 4/ 1-R

3060089

<https://www.phoenixcontact.com/pc/products/3060089>



Insulating sleeve

Insulating sleeve - MPS-IH BK - 0201731

<https://www.phoenixcontact.com/pc/products/0201731>

Insulating sleeve, color: black



Test plugs

Test plugs - MPS-MT - 0201744

<https://www.phoenixcontact.com/pc/products/0201744>

Test plugs, with solder connection up to 1 mm² conductor cross section, color: gray



Plug - UP 4/ 1-R

3060089

<https://www.phoenixcontact.com/pc/products/3060089>



Marker for terminal blocks

Marker for terminal blocks - UC-TMF 6 - 0818140

<https://www.phoenixcontact.com/pc/products/0818140>



Marker for terminal blocks, Sheet, white, unlabeled, can be labeled with: BLUEMARK ID COLOR, BLUEMARK ID, BLUEMARK CLED, PLOTMARK, CMS-P1-PLOTTER, mounting type: snap in, for terminal block width: 6.2 mm, lettering field size: 5.6 x 5.1 mm, Number of individual labels: 80

Marker for terminal blocks

Marker for terminal blocks - UC-TMF 6 CUS - 0824646

<https://www.phoenixcontact.com/pc/products/0824646>



Marker for terminal blocks, can be ordered: by sheet, white, labeled according to customer specifications, mounting type: snap into flat marker groove, for terminal block width: 6.2 mm, lettering field size: 5.6 x 5.1 mm, Number of individual labels: 80

Plug - UP 4/ 1-R

3060089

<https://www.phoenixcontact.com/pc/products/3060089>



Marker for terminal blocks

Marker for terminal blocks - UCT-TMF 6 - 0828746

<https://www.phoenixcontact.com/pc/products/0828746>



Marker for terminal blocks, Sheet, white, unlabeled, can be labeled with: TOPMARK NEO, TOPMARK LASER, BLUEMARK ID COLOR, BLUEMARK ID, BLUEMARK CLED, THERMOMARK PRIME, THERMOMARK CARD 2.0, THERMOMARK CARD, mounting type: snap in, for terminal block width: 6.2 mm, lettering field size: 5.4 x 4.7 mm, Number of individual labels: 60

Marker for terminal blocks

Marker for terminal blocks - UCT-TMF 6 CUS - 0829665

<https://www.phoenixcontact.com/pc/products/0829665>



Marker for terminal blocks, can be ordered: by sheet, white, labeled according to customer specifications, mounting type: snap into flat marker groove, for terminal block width: 6.2 mm, lettering field size: 5.4 x 4.7 mm, Number of individual labels: 60

Plug - UP 4/ 1-R

3060089

<https://www.phoenixcontact.com/pc/products/3060089>



Shield connection clamp

Shield connection clamp - PSH 3- 6 - 3040591

<https://www.phoenixcontact.com/pc/products/3040591>



Shield connection clamp, color: black

Shield connection clamp

Shield connection clamp - PSH 5-10 - 3040601

<https://www.phoenixcontact.com/pc/products/3040601>



Shield connection clamp, color: black

Phoenix Contact 2022 © - all rights reserved
<https://www.phoenixcontact.com>

PHOENIX CONTACT GmbH & Co. KG
Flachsmarktstraße 8
D-32825 Blomberg
+49 (0) 5235-3 00
info@phoenixcontact.com