

# PCB connector - MC 1,5/ 5-STF-3,81

1827732

<https://www.phoenixcontact.com/de/produkte/1827732>

Please be informed that the data shown in this PDF document is generated from our Online Catalog. Please find the complete data in the user documentation. Our General Terms of Use for Downloads are valid.

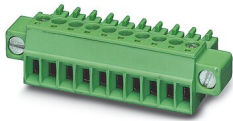

PCB connector, nominal cross section: 1.5 mm<sup>2</sup>, color: green, nominal current: 8 A, rated voltage (III/2): 160 V, contact surface: Tin, type of contact: Female connector, number of potentials: 5, number of rows: 1, number of positions: 5, number of connections: 5, product range: MC 1,5/..-STF, pitch: 3.81 mm, connection method: Screw connection with tension sleeve, screw head form: L Slotted, conductor/PCB connection direction: 0 °, number of solder pins per potential: 1, plug-in system: COMBICON MC 1,5, locking: Screw locking, mounting: Screw flange, type of packaging: packed in cardboard

## Your advantages

- Well-known connection principle allows worldwide use
- Low temperature rise, thanks to maximum contact force
- Allows connection of two conductors
- Screwable flange for superior mechanical stability

# PCB connector - MC 1,5/ 5-STF-3,81



1827732

<https://www.phoenixcontact.com/de/produkte/1827732>

## Commercial Data

Item number	1827732
Packing unit	250 pc
Minimum order quantity	250 pc
Sales Key	E1 - Leiterplattenanschl.
Product Key	AABABB
Catalog Page	Page 191 (C-1-2013)
GTIN	4017918050191
Weight per Piece (including packing)	4,516 g
Weight per Piece (excluding packing)	4,516 g
Customs tariff number	85366990
Country of origin	DE

## Technical Data

### Product properties

Type	Standard
Product line	COMBICON Connectors S
Product type	PCB plug
Number of positions	5
Pitch	3.81 mm
Number of connections	5
Number of rows	1
Mounting flange	Screw flange
Number of potentials	5

### Electrical properties

Nominal current $I_N$	8 A
Nominal voltage $U_N$	160 V
Pollution degree	3
Contact resistance	1.3 mΩ
Rated voltage (III/3)	160 V
Rated surge voltage (III/3)	2.5 kV
Rated voltage (III/2)	160 V
Rated surge voltage (III/2)	2.5 kV

### Connection data

#### Connection technology

Type	Standard
Connector system	COMBICON MC 1,5
Nominal cross section	1.5 mm <sup>2</sup>
Type of contact	Female connector

#### Interlock

Locking type	Screw locking
Mounting flange	Screw flange
Torque	0.3 Nm

#### Conductor connection

Connection method	Screw connection with tension sleeve
Conductor/PCB connection direction	0 °
Conductor cross section solid	0.14 mm <sup>2</sup> ... 1.5 mm <sup>2</sup>
Conductor cross section flexible	0.14 mm <sup>2</sup> ... 1.5 mm <sup>2</sup>
Conductor cross section AWG	28 ... 16
Conductor cross section flexible, with ferrule without plastic sleeve	0.25 mm <sup>2</sup> ... 1.5 mm <sup>2</sup>
Conductor cross section, flexible, with ferrule, with plastic sleeve	0.25 mm <sup>2</sup> ... 0.75 mm <sup>2</sup>

# PCB connector - MC 1,5/ 5-STF-3,81

1827732

<https://www.phoenixcontact.com/de/produkte/1827732>

2 conductors with same cross section, solid	0.08 mm <sup>2</sup> ... 0.5 mm <sup>2</sup>
2 conductors with same cross section, flexible	0.08 mm <sup>2</sup> ... 0.75 mm <sup>2</sup>
2 conductors with same cross section, flexible, with ferrule without plastic sleeve	0.25 mm <sup>2</sup> ... 0.34 mm <sup>2</sup>
2 conductors with the same cross section, flexible, with TWIN ferrule with plastic sleeve	0.5 mm <sup>2</sup> ... 0.5 mm <sup>2</sup>
Cylindrical gauge a x b / diameter	2.4 mm x 1.5 mm / 1.6 mm
Stripping length	7 mm
Torque	0.22 Nm ... 0.25 Nm

## Material specifications

### Material data - contact

Note	WEEE/RoHS-compliant, free of whiskers according to IEC 60068-2-82/JEDEC JESD 201
Contact material	Cu alloy
Surface characteristics	hot-dip tin-plated
Metal surface terminal point (top layer)	Tin (4 - 8 µm Sn)
Metal surface contact area (top layer)	Tin (4 - 8 µm Sn)

### Material data - housing

Housing color	green (6021)
Insulating material	PA
Insulating material group	I
CTI according to IEC 60112	600
Flammability rating according to UL 94	V0
Glow wire flammability index GWFI according to EN 60695-2-12	850
Glow wire ignition temperature GWIT according to EN 60695-2-13	775
Temperature for the ball pressure test according to EN 60695-10-2	125 °C

## Dimensions

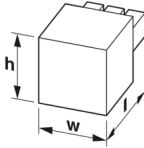
Dimensional drawing	
Pitch	3.81 mm
Width [w]	29.44 mm
Height [h]	11.1 mm
Length [l]	16.1 mm
Installed height	11.1 mm

## Mounting

Drive form screw head	Slotted (L)
-----------------------	-------------

# PCB connector - MC 1,5/ 5-STF-3,81



1827732

<https://www.phoenixcontact.com/de/produkte/1827732>

## Flange

Tightening torque	0.3 Nm
-------------------	--------

## Mechanical tests

### Test for conductor damage and slackening

Specification	IEC 60999-1:1999-11
Result	Test passed

### Pull-out test

Specification	IEC 60999-1:1999-11
Conductor cross section/conductor type/tractive force setpoint/actual value	0.14 mm <sup>2</sup> / solid / > 7 N
	0.14 mm <sup>2</sup> / flexible / > 7 N
	1.5 mm <sup>2</sup> / solid / > 40 N
	1.5 mm <sup>2</sup> / flexible / > 40 N

### Insertion and withdrawal forces

Result	Test passed
No. of cycles	25
Insertion strength per pos. approx.	6 N
Withdraw strength per pos. approx.	4 N

### Torque test

Specification	IEC 60999-1:1999-11
---------------	---------------------

### Contact holder in insert

Specification	IEC 60512-15-1:2008-05
Contact holder in insert Requirements >20 N	Test passed

### Resistance of inscriptions

Specification	IEC 60068-2-70:1995-12
Result	Test passed

### Polarization and coding

Specification	IEC 60512-13-5:2006-02
Result	Test passed

### Visual inspection

Specification	IEC 60512-1-1:2002-02
Result	Test passed

### Dimension check

Specification	IEC 60512-1-2:2002-02
Result	Test passed

## Environmental and real-life conditions

### Vibration test

# PCB connector - MC 1,5/ 5-STF-3,81



1827732

<https://www.phoenixcontact.com/de/produkte/1827732>

Specification	IEC 60068-2-6:2007-12
Frequency	10 - 150 - 10 Hz
Sweep speed	1 octave/min
Amplitude	0.35 mm (10 - 60.1 Hz)
Sweep speed	5g (60.1 - 150 Hz)
Test duration per axis	2.5 h

## Durability test

Specification	IEC 60512-9-1:2010-03
Impulse withstand voltage at sea level	2.95 kV
Contact resistance $R_1$	1.3 m $\Omega$
Contact resistance $R_2$	1.5 m $\Omega$
Insertion/withdrawal cycles	25
Insulation resistance, neighboring positions	> 5 M $\Omega$

## Climatic test

Specification	ISO 6988:1985-02
Corrosive stress	0.2 dm <sup>3</sup> SO <sub>2</sub> on 300 dm <sup>3</sup> /40 °C/1 cycle
Thermal stress	100 °C/168 h
Power-frequency withstand voltage	1.39 kV

## Shocks

Specification	IEC 60068-2-27:2008-02
Pulse shape	Semi-sinusoidal
Acceleration	30g
Shock duration	18 ms
Test directions	X-, Y- and Z-axis (pos. and neg.)

## Ambient conditions

Ambient temperature (operation)	-40 °C ... 100 °C (dependent on the derating curve)
Ambient temperature (storage/transport)	-40 °C ... 70 °C
Relative humidity (storage/transport)	30 % ... 70 %
Ambient temperature (assembly)	-5 °C ... 100 °C

## Electrical tests

### Thermal test | Test group C

Specification	IEC 60512-5-1:2002-02
Tested number of positions	20

### Insulation resistance

Specification	IEC 60512-3-1:2002-02
Insulation resistance, neighboring positions	> 5 M $\Omega$

### Air clearances and creepage distances |

Specification	IEC 60664-1:2007-04
Insulating material group	I

# PCB connector - MC 1,5/ 5-STF-3,81



1827732

<https://www.phoenixcontact.com/de/produkte/1827732>

Comparative tracking index (IEC 60112)	CTI 600
Rated insulation voltage (III/3)	160 V
Rated surge voltage (III/3)	2.5 kV
minimum clearance value - non-homogenous field (III/3)	1.5 mm
minimum creepage distance (III/3)	2 mm
Note on connection cross section	With connected conductor 1.5 mm <sup>2</sup> (solid).
Rated insulation voltage (III/2)	160 V
Rated surge voltage (III/2)	2.5 kV
minimum clearance value - non-homogenous field (III/2)	1.5 mm
minimum creepage distance (III/2)	1.5 mm
Rated insulation voltage (II/2)	320 V
Rated surge voltage (II/2)	2.5 kV
minimum clearance value - non-homogenous field (II/2)	1.5 mm
minimum creepage distance (II/2)	1.6 mm

## Packaging specifications

Type of packaging	packed in cardboard
-------------------	---------------------

Drawings

Diagram

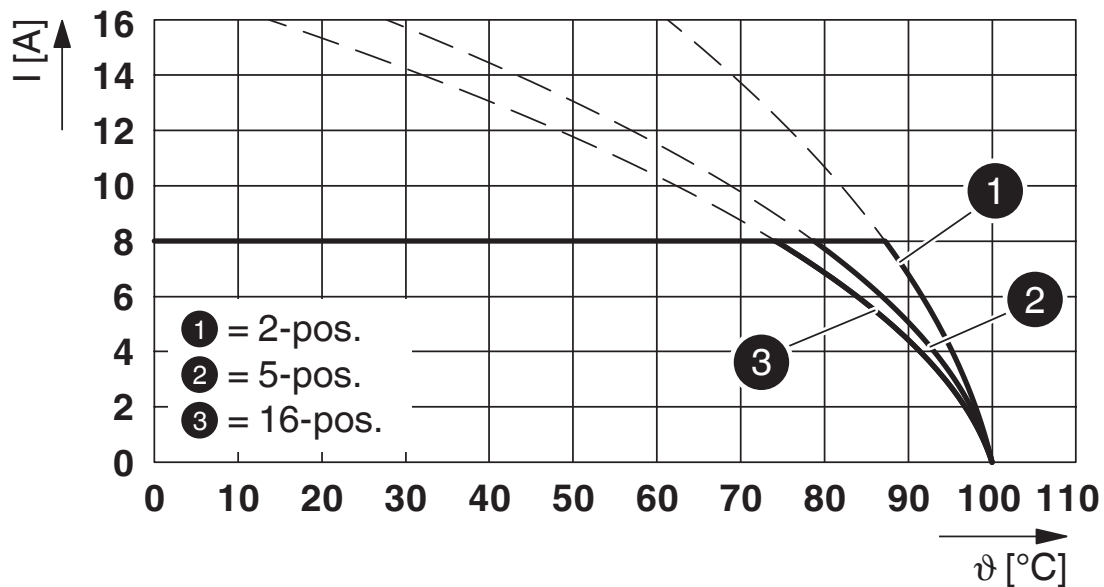

Type: MC 1,5/...-STF-3,81 with SMC 1,5/...-GF-3,81

Diagram

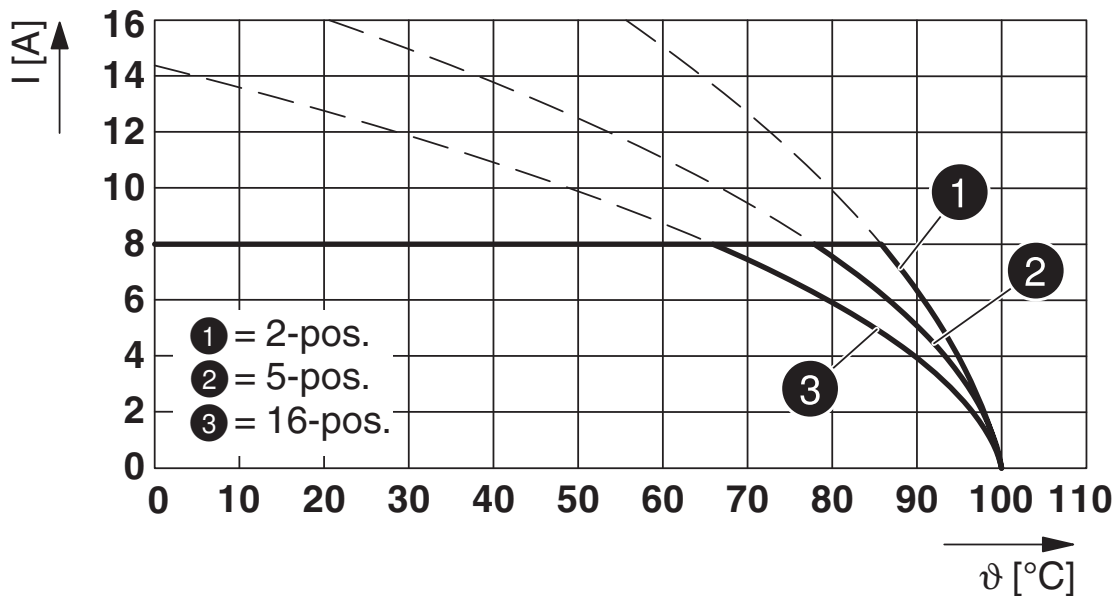

Type: MC 1,5/...-STF-3,81 with MCDV 1,5/...-G1F-3,81



1827732

<https://www.phoenixcontact.com/de/produkte/1827732>

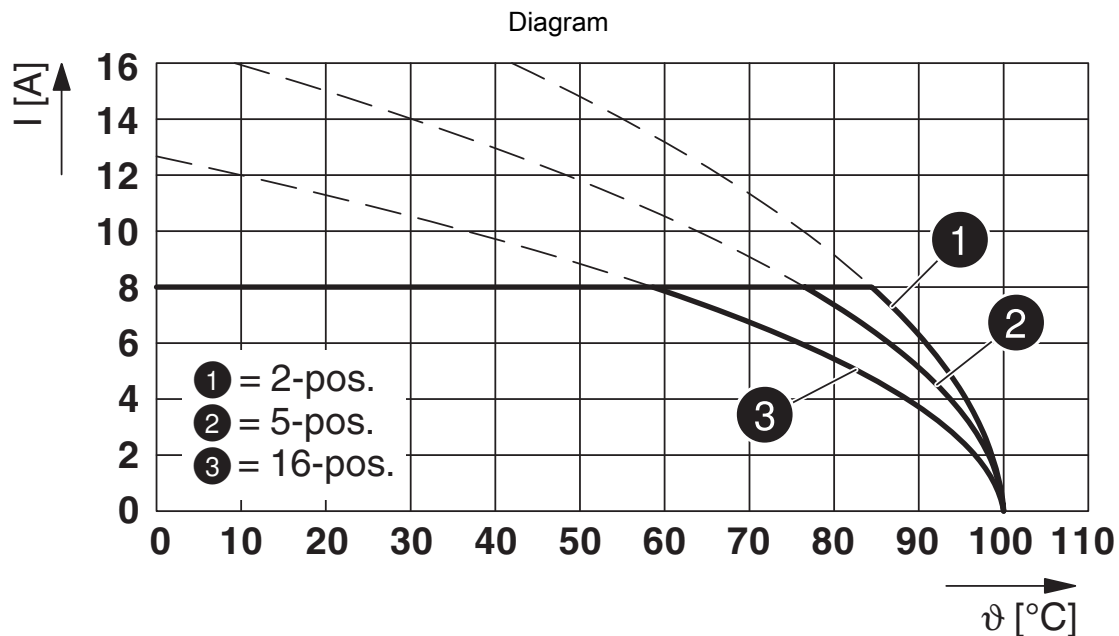

Type: MC 1,5/...-STF-3,81 with MCDV 1,5/...-GF-3,81

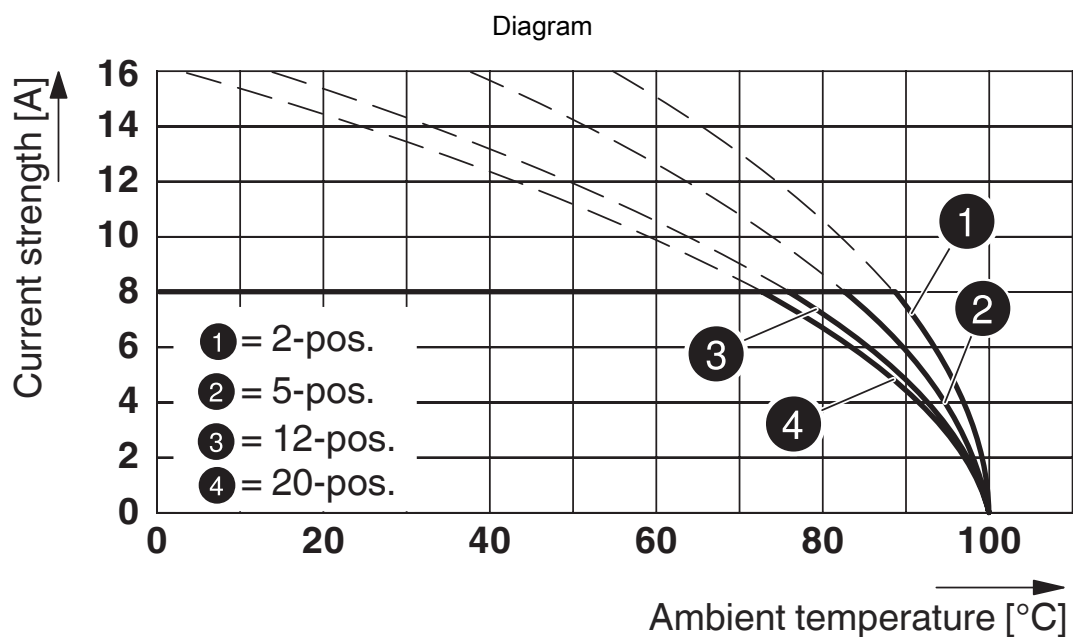

Type: MC 1,5/...-STF-3,81 with MCV 1,5/...-GF-3,81

Dimensional drawing

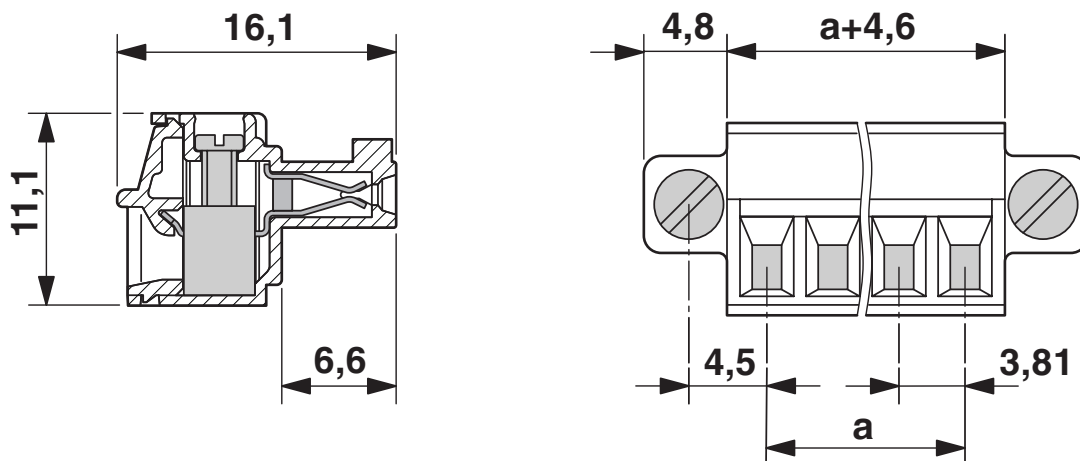

Diagram

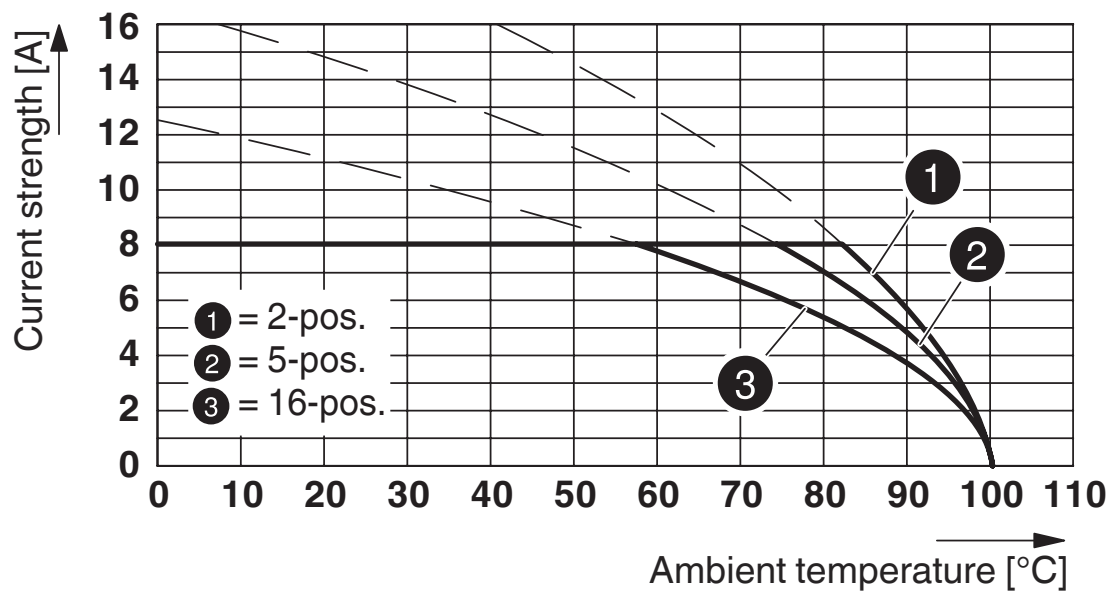

Type: MC 1,5/...-STF-3,81 with MCD 1,5/...-G1F-3,81

# PCB connector - MC 1,5/ 5-STF-3,81



1827732

<https://www.phoenixcontact.com/de/produkte/1827732>

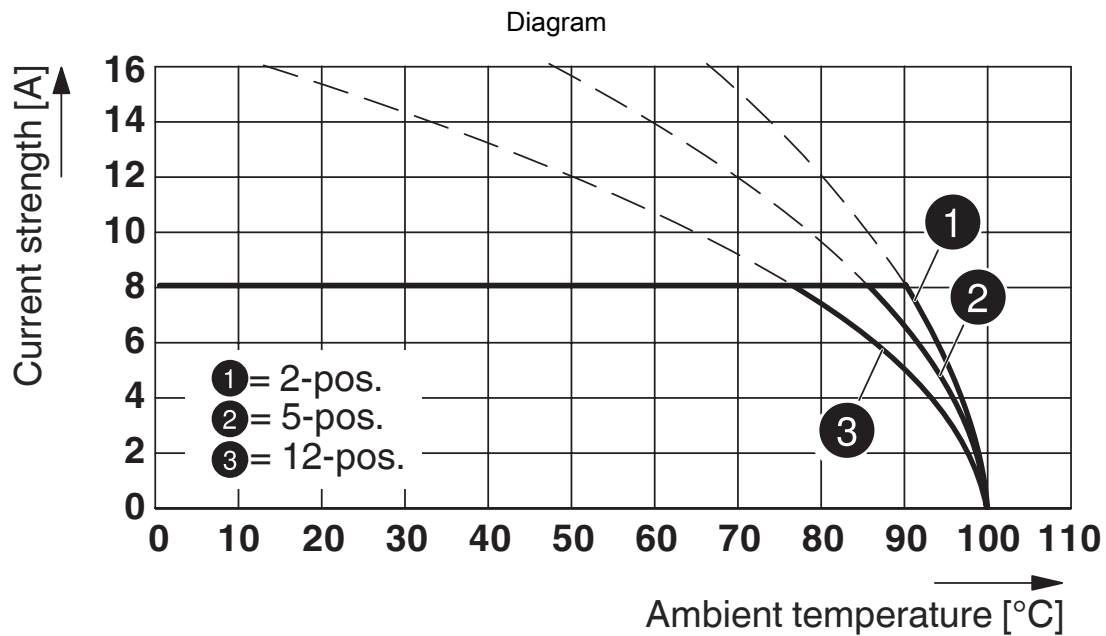

Type: MC 1,5/...-STF-3,81 with MCV 1,5/...-GF-3,81 P26 THR

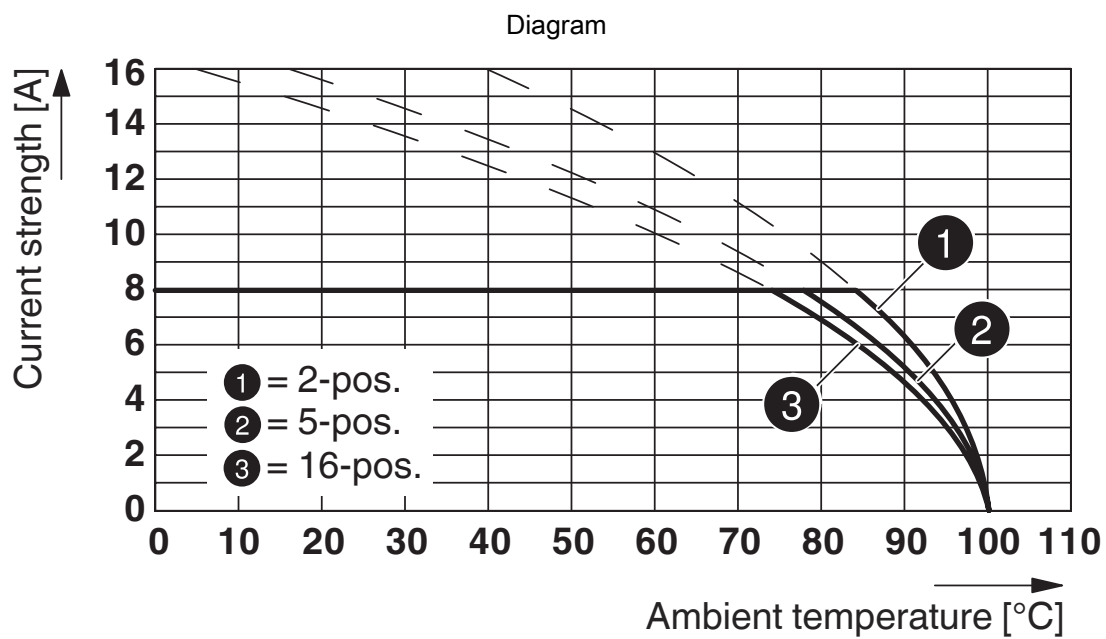

Type: MC 1,5/...-STF-3,81 with DFK-MC 1,5/...-GF-3,81 (with solder connection)

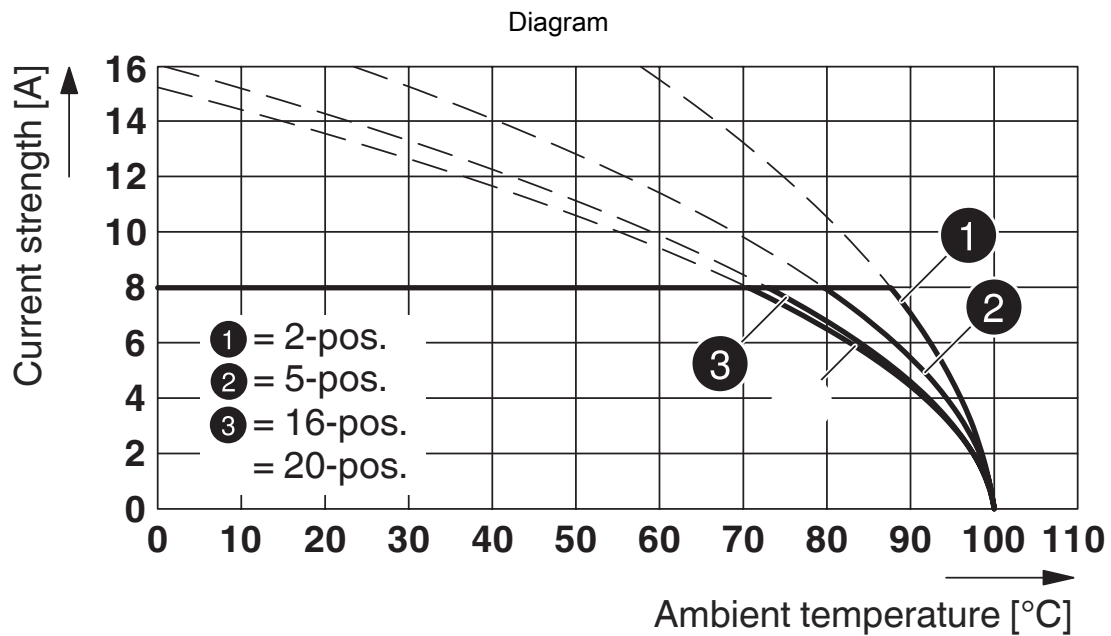

Type: MC 1,5/...-STF-3,81 with MC 1,5/...-GF-3,81 P26THR

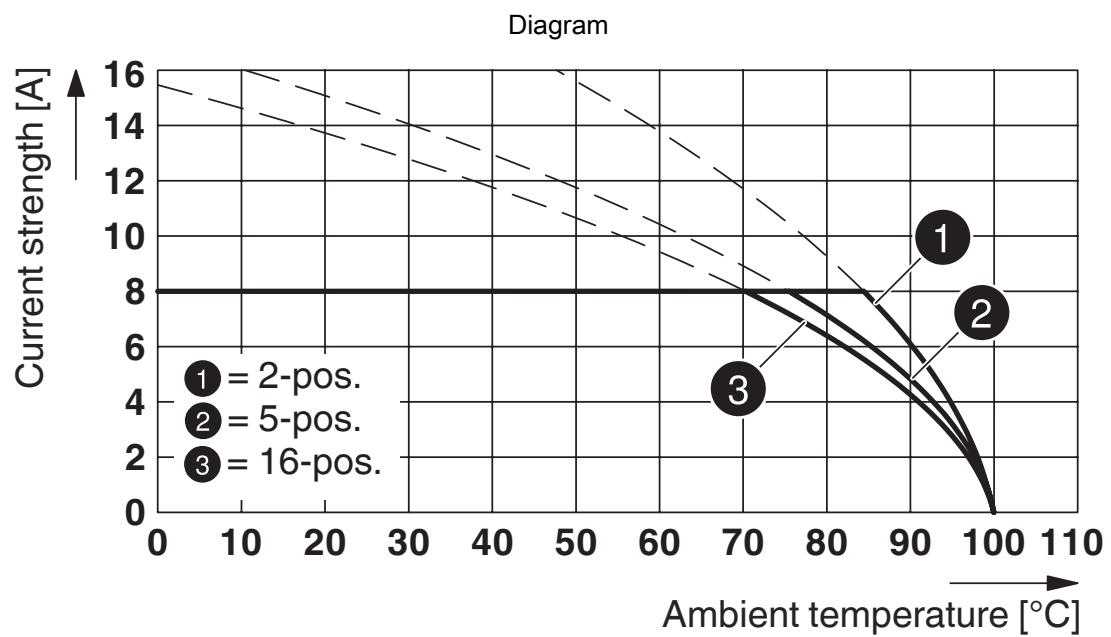

Type: MC 1,5/...-STF-3,81 with IMC 1,5/...-STGF-3,81

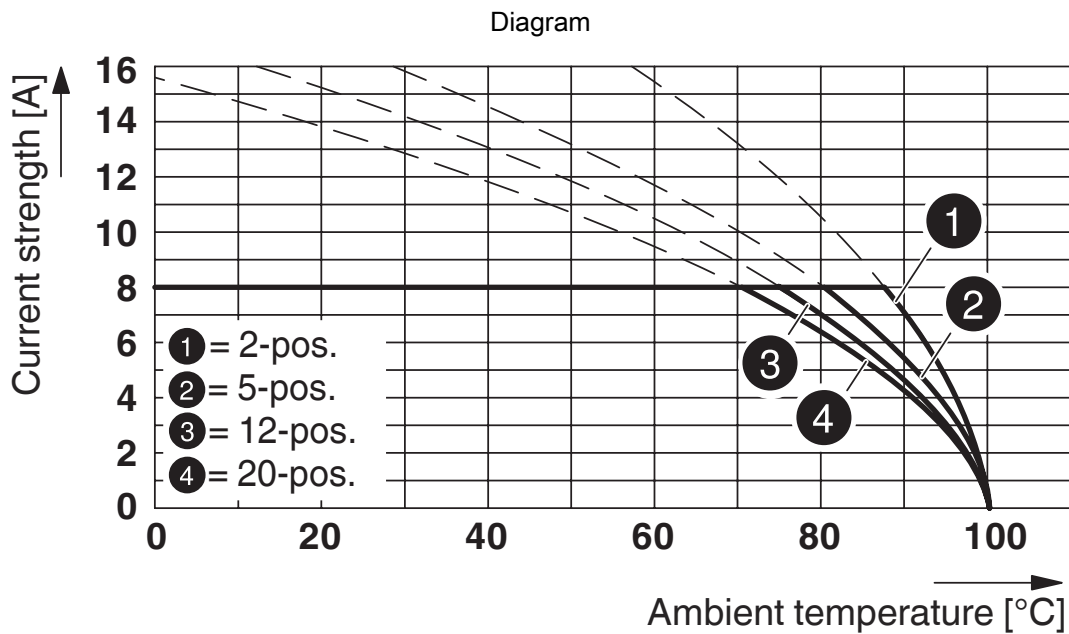

Type: MC 1,5/...-STF-3,81 with MC 1,5/...-GF-3,81

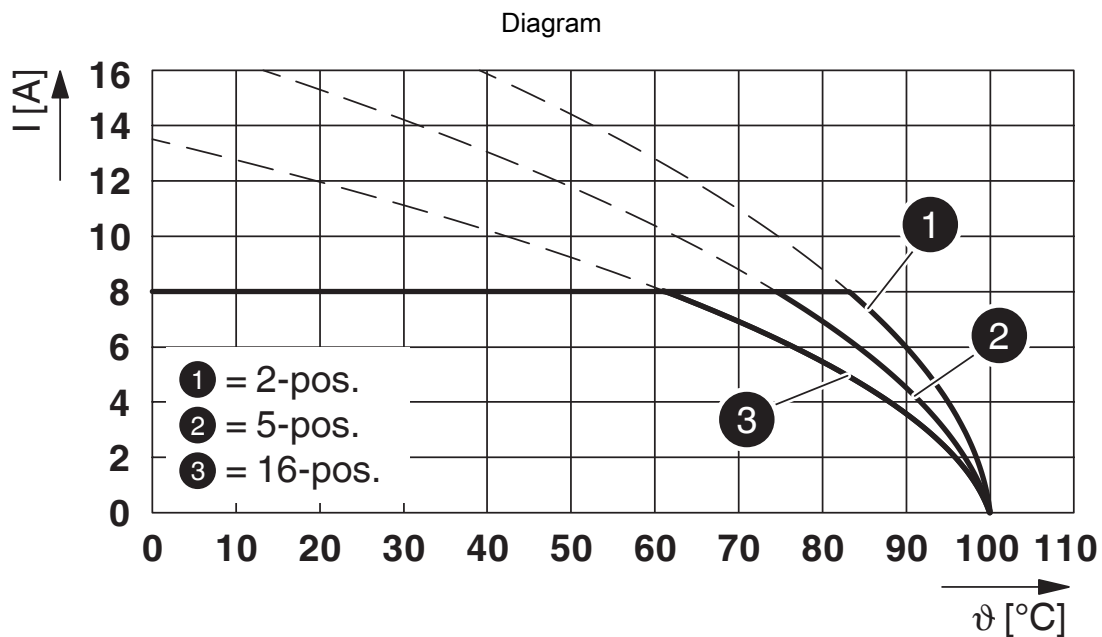

Type: MC 1,5/...-STF-3,81 with MCD 1,5/...-GF-3,81

# PCB connector - MC 1,5/ 5-STF-3,81



1827732

<https://www.phoenixcontact.com/de/produkte/1827732>

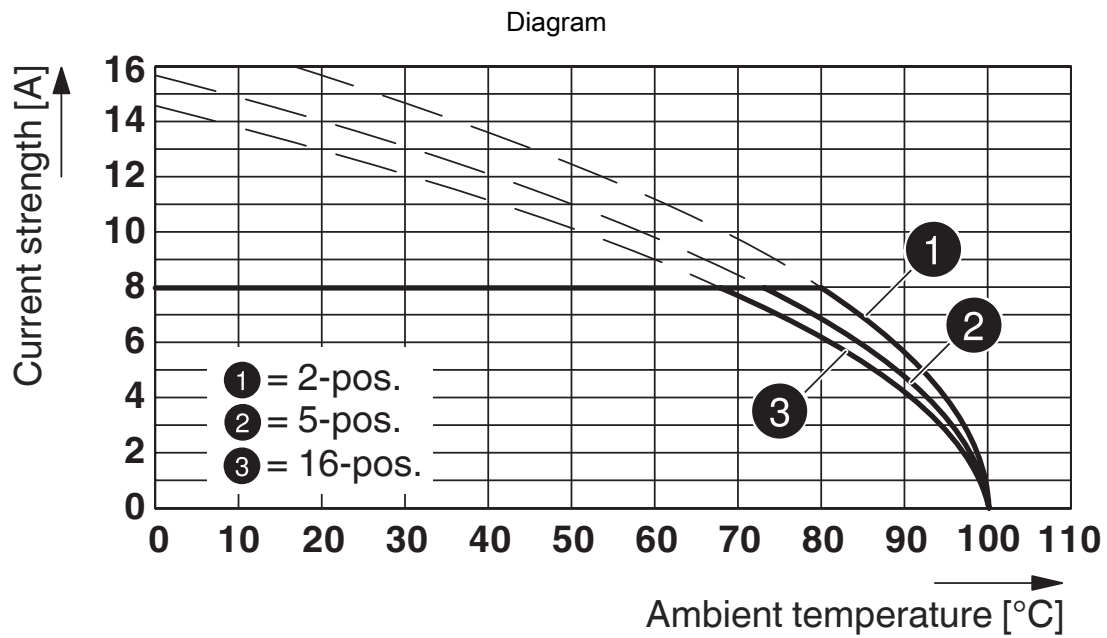

Type: MC 1,5/...-STF-3,81 with DFK-MC 1,5/...-GF-3,81 (with flat plug)

# PCB connector - MC 1,5/ 5-STF-3,81



1827732

<https://www.phoenixcontact.com/de/produkte/1827732>

## Approvals

 <b>CSA</b> Approval ID: 13631				
	Nominal Voltage $U_N$	Nominal Current $I_N$	Cross Section AWG	Cross Section $mm^2$
Use group B	300 V	8 A	28 - 16	-
Use group D	300 V	8 A	28 - 16	-

 <b>IECEE CB Scheme</b> Approval ID: DE1-60987-B1B2				
	Nominal Voltage $U_N$	Nominal Current $I_N$	Cross Section AWG	Cross Section $mm^2$
	160 V	8 A	-	0.2 - 1.5

 <b>EAC</b> Approval ID: B.01687				
--	--	--	--	--

 <b>cULus Recognized</b> Approval ID: E60425-20110128				
	Nominal Voltage $U_N$	Nominal Current $I_N$	Cross Section AWG	Cross Section $mm^2$
Use group B	300 V	8 A	30 - 14	-
Use group D	300 V	8 A	30 - 14	-

 <b>VDE report with production monitoring</b> Approval ID: 40011723				
	Nominal Voltage $U_N$	Nominal Current $I_N$	Cross Section AWG	Cross Section $mm^2$
	160 V	8 A	-	0.2 - 1.5

# PCB connector - MC 1,5/ 5-STF-3,81



1827732

<https://www.phoenixcontact.com/de/produkte/1827732>

## Classifications

### ECLASS

ECLASS-9.0	27440309
ECLASS-10.0.1	27440309
ECLASS-11.0	27460202

### ETIM

ETIM 8.0	EC002638
----------	----------

### UNSPSC

UNSPSC 21.0	39121400
-------------	----------



# PCB connector - MC 1,5/ 5-STF-3,81



1827732

<https://www.phoenixcontact.com/de/produkte/1827732>

## Environmental Product Compliance

REACH SVHC	Lead 7439-92-1
China RoHS	Environmentally Friendly Use Period = 50 years
	For information on hazardous substances, refer to the manufacturer's declaration available under "Downloads"

# PCB connector - MC 1,5/ 5-STF-3,81

1827732

<https://www.phoenixcontact.com/de/produkte/1827732>

## Accessories

### Marker card

Marker card - SK 3,81/2,8:FORTL.ZAHLEN - 0804109

<https://www.phoenixcontact.com/de/produkte/0804109>

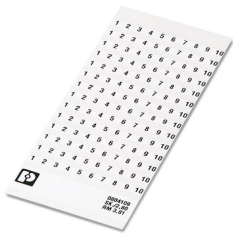

Marker card, white, labeled, horizontal: consecutive numbers 1 ... 10, 11 ... 20, etc. up to 91 ... (99)100, mounting type: adhesive, for terminal block width: 3.81 mm, lettering field size: 3.81 x 2.8 mm

---

### Marker pen

Marker pen - B-STIFT - 1051993

<https://www.phoenixcontact.com/de/produkte/1051993>



Marker pen, for manual labeling of unprinted Zack strips, smear-proof and waterproof, line thickness 0.5 mm

# PCB connector - MC 1,5/ 5-STF-3,81

1827732

<https://www.phoenixcontact.com/de/produkte/1827732>

## Cable housing

Cable housing - KGG-MC 1,5/ 5 - 1834372

<https://www.phoenixcontact.com/de/produkte/1834372>

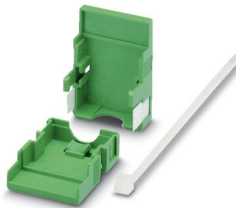

Cable housing, pitch: 3.81 mm, number of positions: 5, dimension a: 21.44 mm, color: green

---

## Screwdriver

Screwdriver - SZS 0,4X2,5 VDE - 1205037

<https://www.phoenixcontact.com/de/produkte/1205037>



Screwdriver, slot-headed, VDE insulated, size: 0.4 x 2.5 x 80 mm, 2-component grip, with non-slip grip

# PCB connector - MC 1,5/ 5-STF-3,81

1827732

<https://www.phoenixcontact.com/de/produkte/1827732>

## Insertion bridge

Insertion bridge - EBPL 2-3,81 - 1733495

<https://www.phoenixcontact.com/de/produkte/1733495>

Insertion bridge for plugs featuring a screw connection with a 3.81 mm pitch



---

## Insertion bridge

Insertion bridge - EBPL 3-3,81 - 1733505

<https://www.phoenixcontact.com/de/produkte/1733505>

Insertion bridge for plugs featuring a screw connection with a 3.81 mm pitch



# PCB connector - MC 1,5/ 5-STF-3,81

1827732

<https://www.phoenixcontact.com/de/produkte/1827732>

## Insertion bridge

Insertion bridge - EBPL 4-3,81 - 1733518

<https://www.phoenixcontact.com/de/produkte/1733518>

Insertion bridge for plugs featuring a screw connection with a 3.81 mm pitch



---

## PCB header

PCB header - MCV 1,5/ 5-GF-3,81 P14 THR - 1707243

<https://www.phoenixcontact.com/de/produkte/1707243>

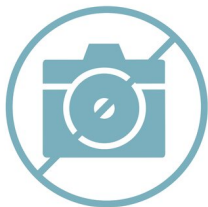

PCB headers, nominal cross section: 1.5 mm<sup>2</sup>, color: black, nominal current: 8 A, rated voltage (III/2): 160 V, contact surface: Tin, type of contact: Male connector, number of potentials: 5, number of rows: 1, number of positions: 5, number of connections: 5, product range: MCV 1,5/..-GF-THR, pitch: 3.81 mm, pin layout: Linear pinning, solder pin [P]: 1.4 mm, number of solder pins per potential: 1, plug-in system: COMBICON MC 1,5, Pin connector pattern alignment: Standard, locking: Screw locking, mounting: Threaded flange, type of packaging: packed in cardboard, For user information and design recommendations for through-hole reflow technology, go to: Downloads

# PCB connector - MC 1,5/ 5-STF-3,81

1827732

<https://www.phoenixcontact.com/de/produkte/1827732>

## PCB header

PCB header - MCV 1,5/ 5-GF-3,81 P26 THR - 1707667

<https://www.phoenixcontact.com/de/produkte/1707667>

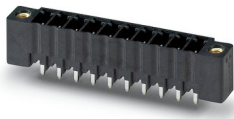

PCB headers, nominal cross section: 1.5 mm<sup>2</sup>, color: black, nominal current: 8 A, rated voltage (III/2): 160 V, contact surface: Tin, type of contact: Male connector, number of potentials: 5, number of rows: 1, number of positions: 5, number of connections: 5, product range: MCV 1,5/..-GF-THR, pitch: 3.81 mm, pin layout: Linear pinning, solder pin [P]: 2.6 mm, number of solder pins per potential: 1, plug-in system: COMBICON MC 1,5, Pin connector pattern alignment: Standard, locking: Screw locking, mounting: Threaded flange, type of packaging: packed in cardboard, For user information and design recommendations for through-hole reflow technology, go to: Downloads

---

Phoenix Contact 2022 © - all rights reserved

<https://www.phoenixcontact.com>

PHOENIX CONTACT Deutschland GmbH

Flachsmarktstraße 8

D-32825 Blomberg

+49 52 35/3-1 20 00

[info@phoenixcontact.de](mailto:info@phoenixcontact.de)