

# Ferrule - A 1,5 -12

3202588

<https://www.phoenixcontact.com/pc/products/3202588>



Please be informed that the data shown in this PDF document is generated from our Online Catalog. Please find the complete data in the user documentation. Our General Terms of Use for Downloads are valid.

---



Ferrule, length: 12 mm, color: silver

---

## Your advantages

- The dimensions of the ferrules conform to DIN 46228-1
- The ferrules without plastic sleeve are made from soft tin-plated electrolytic copper

# Ferrule - A 1,5 -12

3202588

<https://www.phoenixcontact.com/pc/products/3202588>



## Commercial Data

Item number	3202588
Packing unit	1,000 pc
Minimum order quantity	1,000 pc
Sales Key	05
Product Key	BH3412
Catalog Page	Page 480 (C-3-2019)
GTIN	4017918161736
Weight per Piece (including packing)	0.1 g
Weight per Piece (excluding packing)	0.1 g
Customs tariff number	85369010
Country of origin	DE

# Ferrule - A 1,5 -12

3202588

<https://www.phoenixcontact.com/pc/products/3202588>

## Technical Data

### Product properties

Product type	Ferrule
Conductor category	Stranded conductors, class 2, 5, 6 / B, C, K, M

### Connection data

#### Conductor connection

Conductor cross section flexible max.	1.5 mm <sup>2</sup>
Conductor cross section AWG max.	16
Stripping length	12 mm

### Dimensions

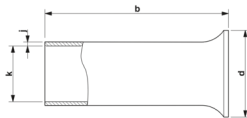
Dimensional drawing	
Length	12 mm
Maximum stripping length	12 mm
Ferrule diameter	1.7 mm
Sleeve wall thickness	0.15 mm
Inner dimensions of the insulating collar	2.8 mm

### Material specifications

Color	silver
Material	CU-DHP
Coating	tin-plated (galvanic)

### Connector

Material	CU-DHP
Material	CU-DHP

### Environmental and real-life conditions

#### Ambient conditions

Permanent temperature	105 °C
Short-term temperature	120 °C

# Ferrule - A 1,5 -12

3202588

<https://www.phoenixcontact.com/pc/products/3202588>



## Drawings

Dimensional drawing

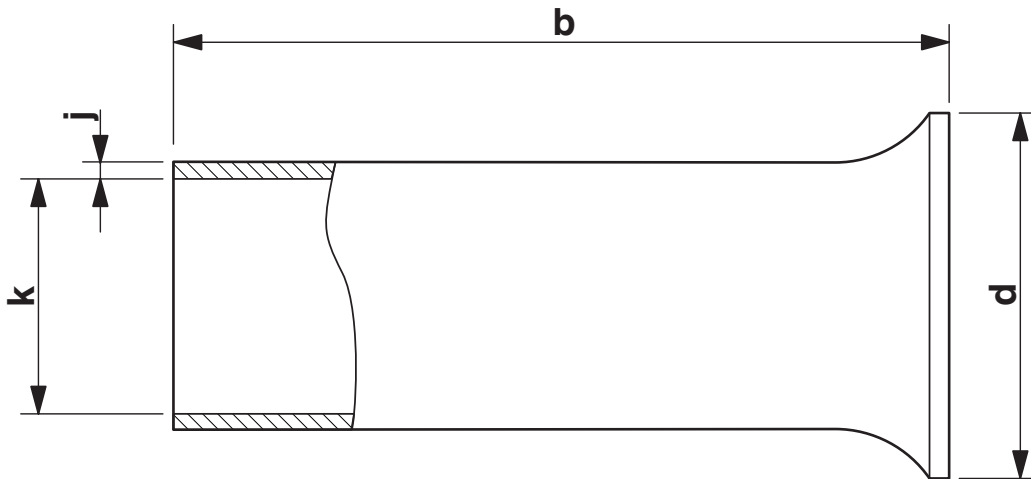

Sleeve length (b), insulating collar inner dimension (d), sleeve diameter (k), sleeve wall thickness (j)

# Ferrule - A 1,5 -12



3202588

<https://www.phoenixcontact.com/pc/products/3202588>

## Approvals



**CSA**

Approval ID: 247397



**UL Listed**

Approval ID: E488001

	Nominal Voltage $U_N$	Nominal Current $I_N$	Cross Section AWG	Cross Section $\text{mm}^2$
			-	-



**cUL Listed**

Approval ID: E488001

	Nominal Voltage $U_N$	Nominal Current $I_N$	Cross Section AWG	Cross Section $\text{mm}^2$
			-	-



**CSAus**

Approval ID: 247397

**cULus Listed**

**cCSAus**

# Ferrule - A 1,5 -12

3202588

<https://www.phoenixcontact.com/pc/products/3202588>



## Classifications

### ECLASS

ECLASS-9.0	27400201
ECLASS-10.0.1	27400201
ECLASS-11.0	27400201

### ETIM

ETIM 8.0	EC000005
----------	----------

### UNSPSC

UNSPSC 21.0	27121700
-------------	----------

# Ferrule - A 1,5 -12

3202588

<https://www.phoenixcontact.com/pc/products/3202588>



## Environmental Product Compliance

China RoHS	Environmentally friendly use period: unlimited = EFUP-e
	No hazardous substances above threshold values

# Ferrule - A 1,5 -12

3202588

<https://www.phoenixcontact.com/pc/products/3202588>



## Accessories

### Crimping pliers

Crimping pliers - CRIMPFOX CENTRUS 6S - 1213144

<https://www.phoenixcontact.com/pc/products/1213144>



Crimping pliers, for uninsulated and insulated ferrules, DIN 46228 Part 1 and 4, from 0.14 mm<sup>2</sup> ... 6 mm<sup>2</sup>, also for TWIN ferrules up to 2 x 4 mm<sup>2</sup>, automatic cross section adjustment, lateral insertion, equipped with fall protection

---

### Crimping pliers

Crimping pliers - CRIMPFOX CENTRUS 6H - 1213146

<https://www.phoenixcontact.com/pc/products/1213146>



Crimping pliers, for uninsulated and insulated ferrules, DIN 46228 Part 1 and 4, from 0.14 mm<sup>2</sup> ... 6 mm<sup>2</sup>, also for TWIN ferrules up to 2 x 4 mm<sup>2</sup>, automatic cross section adjustment, lateral insertion, equipped with fall protection



# Ferrule - A 1,5 -12

3202588

<https://www.phoenixcontact.com/pc/products/3202588>



## Crimping pliers

Crimping pliers - CRIMPFOX CENTRUS 10S - 1213154

<https://www.phoenixcontact.com/pc/products/1213154>



Crimping pliers, for uninsulated and insulated ferrules, DIN 46228 Part 1 and 4, from 0.14 mm<sup>2</sup> ... 10 mm<sup>2</sup>, also for TWIN ferrules up to 2 x 4 mm<sup>2</sup>, automatic cross section adjustment, lateral insertion, equipped with fall protection

---

## Crimping pliers

Crimping pliers - CRIMPFOX CENTRUS 10H - 1213156

<https://www.phoenixcontact.com/pc/products/1213156>



Crimping pliers, for uninsulated and insulated ferrules, DIN 46228 Part 1 and 4, from 0.14 mm<sup>2</sup> ... 10 mm<sup>2</sup>, also for TWIN ferrules up to 2 x 4 mm<sup>2</sup>, automatic cross section adjustment, lateral insertion, equipped with fall protection

# Ferrule - A 1,5 -12

3202588

<https://www.phoenixcontact.com/pc/products/3202588>



## Crimping pliers

Crimping pliers - CRIMPFOX 10S - 1212045

<https://www.phoenixcontact.com/pc/products/1212045>



Crimping pliers, for ferrules without insulating collar according to DIN 46228 Part 1 and ferrules with insulating collar according to DIN 46228 Part 4, 0.14 mm<sup>2</sup> ... 10 mm<sup>2</sup>, unlockable pressure lock, lateral entry

---

## Crimping pliers

Crimping pliers - CRIMPFOX 6H - 1212046

<https://www.phoenixcontact.com/pc/products/1212046>



Crimping pliers, for ferrules without insulating collar according to DIN 46228 Part 1 and ferrules with insulating collar according to DIN 46228 Part 4, 0.14 mm<sup>2</sup> ... 6 mm<sup>2</sup>, unlockable pressure lock, lateral entry

# Ferrule - A 1,5 -12

3202588

<https://www.phoenixcontact.com/pc/products/3202588>

## Crimping pliers

Crimping pliers - CRIMPFOX 2,5-M - 1212719

<https://www.phoenixcontact.com/pc/products/1212719>



Crimping pliers, for ferrules without insulating collar according to DIN 46228 Part 1 and ferrules with insulating collar according to DIN 46228 Part 4, 0.25 mm<sup>2</sup> ... 2.5 mm<sup>2</sup>, lateral entry, trapezoidal crimp

---

## Crimping pliers

Crimping pliers - CRIMPFOX 6-M - 1212720

<https://www.phoenixcontact.com/pc/products/1212720>



Crimping pliers, for ferrules without insulating collar according to DIN 46228 Part 1 and ferrules with insulating collar according to DIN 46228 Part 4, 0.25 mm<sup>2</sup> ... 6.0 mm<sup>2</sup>, lateral entry, trapezoidal crimp

# Ferrule - A 1,5 -12

3202588

<https://www.phoenixcontact.com/pc/products/3202588>

## Crimping pliers

Crimping pliers - CRIMPFOX 6 - 1212034

<https://www.phoenixcontact.com/pc/products/1212034>



Crimping pliers, for ferrules without insulating collar according to DIN 46228 Part 1 and ferrules with insulating collar according to DIN 46228 Part 4, 0.25 mm<sup>2</sup> ... 6.0 mm<sup>2</sup>, lateral entry, trapezoidal crimp

---

## Crimping pliers

Crimping pliers - CRIMPFOX DUO 10 - 1031721

<https://www.phoenixcontact.com/pc/products/1031721>



Crimping pliers, type of contact: Insulated and uninsulated ferrules, min. cross section: 0.14 mm<sup>2</sup>, max. cross section: 10 mm<sup>2</sup>, for TWIN ferrules up to 2 x 4 mm<sup>2</sup>, automatic cross section adjustment, rotating die, lateral and frontal insertion, compression: Trapezoidal crimp, black/green

# Ferrule - A 1,5 -12

3202588

<https://www.phoenixcontact.com/pc/products/3202588>



## Crimping pliers

Crimping pliers - CRIMPFOX 10T-F - 1134913

<https://www.phoenixcontact.com/pc/products/1134913>



Crimping pliers, type of contact: Insulated and uninsulated ferrules, standards/specifications: DIN 46228-1, DIN 46228-4, min. cross section: 0.14 mm<sup>2</sup>, max. cross section: 10 mm<sup>2</sup>, For TWIN ferrules up to 2 x 4 mm<sup>2</sup>, automatic cross section adjustment, frontal insertion, compression: Trapezoidal crimp, black

---

## Crimping pliers

Crimping pliers - CRIMPFOX 6S-F - 1212043

<https://www.phoenixcontact.com/pc/products/1212043>



Crimping pliers, for ferrules without insulating collar according to DIN 46228 Part 1 and ferrules with insulating collar according to DIN 46228 Part 4, 0.5 mm<sup>2</sup> ... 6 mm<sup>2</sup>, front entry, square crimp

# Ferrule - A 1,5 -12

3202588

<https://www.phoenixcontact.com/pc/products/3202588>



## Crimping pliers

Crimping pliers - CRIMPFOX 16 S - 1207983

<https://www.phoenixcontact.com/pc/products/1207983>



Crimping pliers for ferrules up to 16 mm<sup>2</sup>

---

Phoenix Contact 2022 © - all rights reserved

<https://www.phoenixcontact.com>

PHOENIX CONTACT GmbH & Co. KG

Flachsmarktstraße 8

D-32825 Blomberg

+49 (0) 5235-3 00

[info@phoenixcontact.com](mailto:info@phoenixcontact.com)