

Connector - SACC-M 8MS-4QO-0,5-M



1441037

<https://www.phoenixcontact.com/pc/products/1441037>

Please be informed that the data shown in this PDF document is generated from our Online Catalog. Please find the complete data in the user documentation. Our General Terms of Use for Downloads are valid.



Connector, Universal, 4-position, Plug straight M8, Coding: A, Insulation displacement connection, knurl material: Nickel-plated brass, external cable diameter 2.5 mm ... 5 mm

Your advantages

- Safe use in the field, thanks to a high degree of protection
- Insulation displacement connection: innovative and time-saving assembly without stripping the single wire

Connector - SACC-M 8MS-4QO-0,5-M



1441037

<https://www.phoenixcontact.com/pc/products/1441037>

Commercial Data

Item number	1441037
Packing unit	1 pc
Minimum order quantity	1 pc
Product Key	BF2BCA
Catalog Page	Page 16 (C-2-2019)
GTIN	4046356515924
Weight per Piece (including packing)	8.44 g
Weight per Piece (excluding packing)	8.44 g
Customs tariff number	85366990
Country of origin	DE

Connector - SACC-M 8MS-4QO-0,5-M

1441037

<https://www.phoenixcontact.com/pc/products/1441037>

Technical Data

Notes

Assembly instruction:

NOTE: Observe the permissible bending radii when laying conductors, since the degree of protection may be put in jeopardy if the bending forces are too high. Alleviate mechanical loads upstream of the connector, e.g. by using cable ties.

Product properties

Product type	Circular connector (cable-side)
Number of positions	4
No. of cable outlets	1
Shielded	no
Coding	A - standard
Cable outlet	straight

Insulation characteristics

Overvoltage category	II
Degree of pollution	3

Ambient conditions

Degree of protection	IP65 IP67
Ambient temperature (operation)	-25 °C ... 80 °C (Plug / socket)

Dimensions

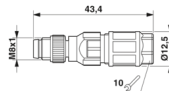
Dimensional drawing	
Length	43.4 mm

External dimensions

Outside diameter	2.5 mm ... 5 mm ±0.2 mm
------------------	-------------------------

Housing

Diameter housing	12.5 mm
------------------	---------

Connector

Insertion/withdrawal cycles	≥ 100
-----------------------------	-------

Header 1

Head design	Plug
Head cable outlet	straight
Head thread type	M8

Connector - SACC-M 8MS-4QO-0,5-M



1441037

<https://www.phoenixcontact.com/pc/products/1441037>

Coding	A-coded
Number of positions	4
Coding	A - standard
Insertion/withdrawal cycles	≥ 100
Connection method	Insulation displacement connection
Contact material	CuSn
Contact surface material	Ni/Au
Number of positions	4
Coding	A - standard
Insertion/withdrawal cycles	≥ 100
Connection method	Insulation displacement connection
Contact material	CuSn
Contact surface material	Ni/Au

Electrical properties

Rated surge voltage	0.8 kV
Contact resistance	≤ 5 mΩ
Insulation resistance	≥ 100 MΩ
Nominal voltage U_N	30 V AC
	30 V DC
Nominal current I_N	4 A

Material specifications

Color Handle area	black
Flammability rating according to UL 94	HB
Sealing material	NBR
Material of grip body	PA 6
Contact material	CuSn
Contact surface material	Ni/Au
Contact carrier material	TPU GF
Cable gland material	Nickel-plated brass
Wire insulation material	PVC / PE / PP / rubber

Connection data

Conductor connection

Connection method	Insulation displacement connection
Conductor cross section flexible	0.25 mm ² ... 0.5 mm ²
Cross section AWG	24 ... 20

Pin assignment

Contact Color (signal designation) Contact (optional)	1 = BN
	2 = WH
	3 = BU
	4 = BK

Connector - SACC-M 8MS-4QO-0,5-M



1441037

<https://www.phoenixcontact.com/pc/products/1441037>

Standards and regulations

M8

Standards/specifications	IEC 61076-2-104
--------------------------	-----------------

Cable / line

Cable structure

Signal type/category	Universal
External cable diameter	2.5 mm ... 5 mm

Connector - SACC-M 8MS-4QO-0,5-M

1441037

<https://www.phoenixcontact.com/pc/products/1441037>

Drawings

Schematic diagram

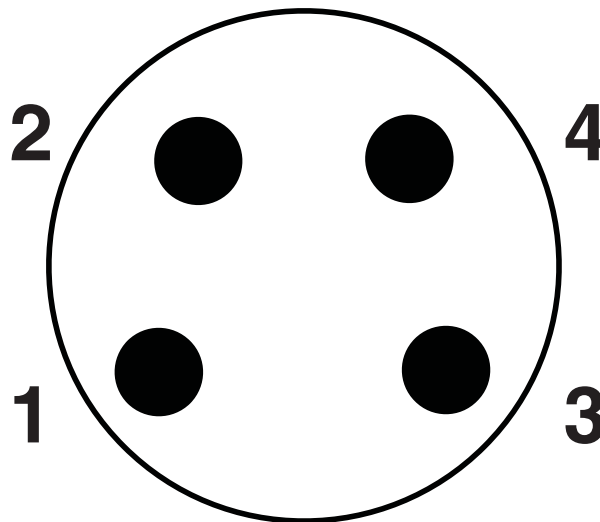

Pin assignment M8 plug, 4-pos., view male side

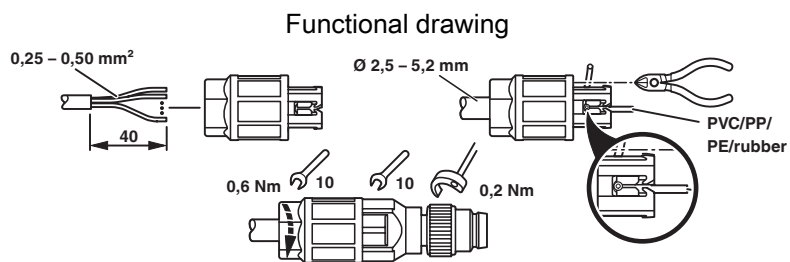

Connector - SACC-M 8MS-4QO-0,5-M

1441037

<https://www.phoenixcontact.com/pc/products/1441037>



Dimensional drawing

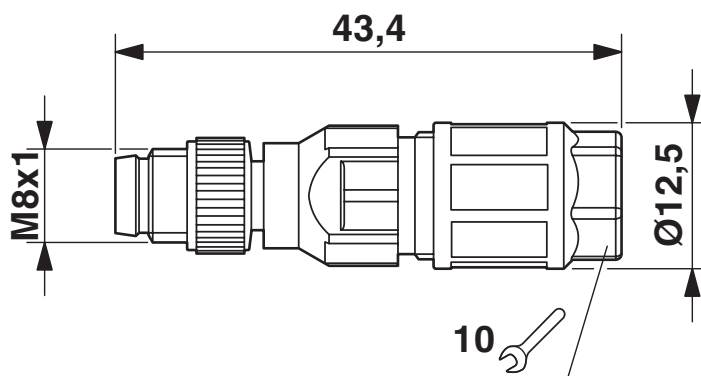

M8 x 1 male plug, straight version

Connector - SACC-M 8MS-4QO-0,5-M





1441037

<https://www.phoenixcontact.com/pc/products/1441037>

Approvals

 cUL Recognized Approval ID: FILE E 118976	Nominal Voltage U_N	Nominal Current I_N	Cross Section AWG	Cross Section mm^2
	29 V	4 A	24 - 20	-

 UL Recognized Approval ID: FILE E 118976	Nominal Voltage U_N	Nominal Current I_N	Cross Section AWG	Cross Section mm^2
	29 V	4 A	24 - 20	-

 EAC Approval ID: RU C-DE.AI30.B.01102

 EAC Approval ID: EAC-Zulassung
--

 EAC Approval ID: RU C-DE.BL08.B.00511

cULus Recognized

Connector - SACC-M 8MS-4QO-0,5-M



1441037

<https://www.phoenixcontact.com/pc/products/1441037>

Classifications

ECLASS

ECLASS-10.0.1	27440102
ECLASS-9.0	27440102
ECLASS-11.0	27440102

ETIM

ETIM 8.0	EC002635
----------	----------

UNSPSC

UNSPSC 21.0	39121400
-------------	----------

Connector - SACC-M 8MS-4QO-0,5-M



1441037

<https://www.phoenixcontact.com/pc/products/1441037>

Environmental Product Compliance

REACH SVHC	Lead 7439-92-1
China RoHS	Environmentally Friendly Use Period = 50 years
	For information on hazardous substances, refer to the manufacturer's declaration available under "Downloads"

Connector - SACC-M 8MS-4QO-0,5-M

1441037

<https://www.phoenixcontact.com/pc/products/1441037>

Accessories

Cable reel

Cable reel - SAC-4P-100,0-PUR/0,25 - 1501692

<https://www.phoenixcontact.com/pc/products/1501692>



By the meter, Cable reel, PUR halogen-free, black-gray RAL 7021, 4-wire, color single wire: brown, white, blue, black, cable length: 100 m

Cable reel

Cable reel - SAC-4P-100,0-PUR/0,34 - 1501663

<https://www.phoenixcontact.com/pc/products/1501663>



By the meter, Cable reel, PUR halogen-free, black-gray RAL 7021, 4-wire, color single wire: brown, white, blue, black, cable length: 100 m

Connector - SACC-M 8MS-4QO-0,5-M

1441037

<https://www.phoenixcontact.com/pc/products/1441037>

Torque screwdriver

Torque screwdriver - TSD 02 SAC - 1208487

<https://www.phoenixcontact.com/pc/products/1208487>



Torque screwdriver, with preset torque of 0.2 Nm and 4 mm hexagonal drive for M8 connectors

Torque screwdriver

Torque screwdriver - TSD-M 1,2NM - 1212224

<https://www.phoenixcontact.com/pc/products/1212224>



Torque screw driver, accuracy as per EN ISO 6789 standard, adjustable from 0.3 - 1.2 Nm

Connector - SACC-M 8MS-4QO-0,5-M



1441037

<https://www.phoenixcontact.com/pc/products/1441037>

Adapter insert

Adapter insert - TSD-M SAC-BIT ADAPTER - 1212600

<https://www.phoenixcontact.com/pc/products/1212600>



Adapter bit for TSD-M...torque tools, E6.3-1/4" drive with 4 mm hexagon to accommodate SAC bits

Sealing cap

Sealing cap - PROT-M 8 FS-PA-CHAIN - 1430857

<https://www.phoenixcontact.com/pc/products/1430857>

M8 sealing cap made of plastic with fixing band for sensor cables, for M8 plugs



Connector - SACC-M 8MS-4QO-0,5-M

1441037

<https://www.phoenixcontact.com/pc/products/1441037>

Tool

Tool - SAC BIT M8-D10 - 1208461

<https://www.phoenixcontact.com/pc/products/1208461>



Nut for assembling M8 connectors with longitudinal knurl and a knurl diameter of 10 mm, for 4 mm hexagonal drive

Phoenix Contact 2022 © - all rights reserved

<https://www.phoenixcontact.com>

PHOENIX CONTACT GmbH & Co. KG

Flachsmarktstraße 8

D-32825 Blomberg

+49 (0) 5235-3 00

info@phoenixcontact.com