

# Solid-state relay terminal block - DEK-OE- 24DC/ 24DC/100KHZ



2964283

<https://www.phoenixcontact.com/de/produkte/2964283>

Please be informed that the data shown in this PDF document is generated from our Online Catalog. Please find the complete data in the user documentation. Our General Terms of Use for Downloads are valid.

---



Input solid-state relay, transmission frequency: 100 kHz, with LED and protective circuit in input and output circuits, input: 24 V DC, output: 4 - 30 V DC/50 mA

---

## Your advantages

- With capacitor on the input side for interference suppression
- Limit frequency of up to 100 kHz
- Includes signal inputs on PLC counter boards

# Solid-state relay terminal block - DEK-OE- 24DC/ 24DC/100KHZ



2964283

<https://www.phoenixcontact.com/de/produkte/2964283>

## Commercial Data

Item number	2964283
Packing unit	10 pc
Minimum order quantity	1 pc
Sales Key	G1 - Relais
Product Key	CK61D1
Catalog Page	Page 452 (C-5-2019)
GTIN	4017918107413
Weight per Piece (including packing)	22,24 g
Weight per Piece (excluding packing)	18,172 g
Customs tariff number	85364190
Country of origin	CN

# Solid-state relay terminal block - DEK-OE- 24DC/ 24DC/100KHZ



2964283

<https://www.phoenixcontact.com/de/produkte/2964283>

## Technical Data

### Notes

Note on application	Use of EB 80-DIK... bridges in the DEK terminal blocks: Absorption of humidity from the ambient air as well as an unfavorable tolerance between a larger number of DEK terminal blocks and the EB 80-DIK... bridge may cause (minor) expansion of the DEK housing. When the EB 80-DIK... bridges are used, therefore, it is recommended that these be disconnected after about 10 to 12 DEK terminal blocks and a wire bridge to the next DEK terminal block be inserted in their place.
Utilization restriction	
EMC note	EMC: class A product, see manufacturer's declaration in the download area

### Product properties

Product type	Solid-state relay module
Application	100 kHz input optocoupler
Operating mode	100% operating factor

### Insulation characteristics

Overvoltage category	II
Pollution degree	2
Insulation	Basic insulation

### Electrical properties

Maximum power dissipation for nominal condition	3 mW
Test voltage Input/output	2.5 kV AC (Input/output)

### Input data

Nominal input voltage $U_N$	24 V DC
Input voltage range in reference to $U_N$	0.8 ... 1.2
Input voltage range	19.2 V DC ... 28.8 V DC
Switching threshold "0" signal in reference to $U_N$	$\leq 0.4$
Switching threshold "1" signal in reference to $U_N$	$\geq 0.8$
Typical input current at $U_N$	6 mA
Typical response time	1.5 $\mu$ s
Typical turn-off time	2 $\mu$ s
Operating voltage display	Yellow LED
Protective circuit	Reverse polarity protection; Polarity protection diode Surge protection
Transmission frequency	100 kHz

### Output data

Contact type	1 N/O contact
--------------	---------------

# Solid-state relay terminal block - DEK-OE- 24DC/ 24DC/100KHZ



2964283

<https://www.phoenixcontact.com/de/produkte/2964283>

Design of digital output	electronic
Output voltage range	4 V DC ... 30 V DC
Limiting continuous current	50 mA
Quiescent current	4.3 mA
Voltage drop at max. limiting continuous current	≤ 0.5 V DC
Output circuit	3-conductor, ground-referenced
Protective circuit	Surge protection; Suppressor diode

## Connection data

Connection method	Screw connection
Stripping length	8 mm
Screw thread	M3
Conductor cross section solid	0.2 mm <sup>2</sup> ... 2.5 mm <sup>2</sup>
Conductor cross section flexible	0.2 mm <sup>2</sup> ... 2.5 mm <sup>2</sup>
Conductor cross section AWG	24 ... 14
Torque	0.5 Nm

## Dimensions

Width	6.2 mm
Height	80 mm
Depth	56 mm

## Environmental and real-life conditions

### Ambient conditions

Ambient temperature (operation)	-20 °C ... 60 °C
Ambient temperature (storage/transport)	-20 °C ... 70 °C

## Standards and regulations

Standards/regulations	IEC 60664
	EN 50178

## Mounting

Mounting type	DIN rail mounting
Assembly instructions	in rows with zero spacing
Mounting position	any

# Solid-state relay terminal block - DEK-OE- 24DC/ 24DC/100KHZ

2964283

<https://www.phoenixcontact.com/de/produkte/2964283>

## Drawings

Circuit diagram

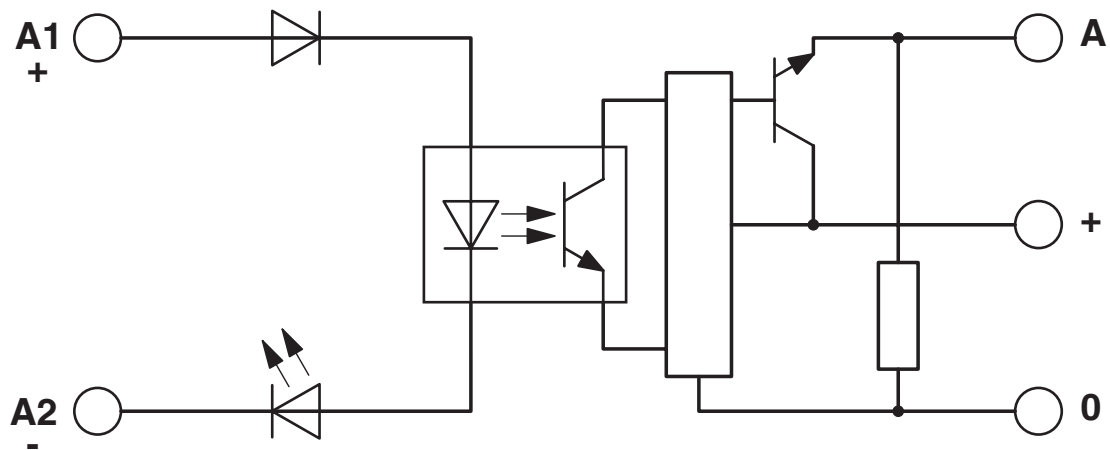

# Solid-state relay terminal block - DEK-OE- 24DC/ 24DC/100KHZ



2964283

<https://www.phoenixcontact.com/de/produkte/2964283>

## Approvals



**EAC**

Approval ID: TR\_TS\_D\_00573\_c

# Solid-state relay terminal block - DEK-OE- 24DC/ 24DC/100KHZ



2964283

<https://www.phoenixcontact.com/de/produkte/2964283>

## Classifications

### ECLASS

ECLASS-9.0	27371604
ECLASS-10.0.1	27371604
ECLASS-11.0	27371604

### ETIM

ETIM 8.0	EC001504
----------	----------

### UNSPSC

UNSPSC 21.0	39122300
-------------	----------

# Solid-state relay terminal block - DEK-OE- 24DC/ 24DC/100KHZ



2964283

<https://www.phoenixcontact.com/de/produkte/2964283>

## Environmental Product Compliance

REACH SVHC	Lead 7439-92-1
	Hexahydromethylphthalic anhydride
China RoHS	Environmentally Friendly Use Period = 50 years
	For information on hazardous substances, refer to the manufacturer's declaration available under "Downloads"



# Solid-state relay terminal block - DEK-OE- 24DC/ 24DC/100KHZ

2964283

<https://www.phoenixcontact.com/de/produkte/2964283>

## Accessories

 Note: Applying some accessories below might limit this product.

### Insertion bridge

Insertion bridge - EB 2- DIK RD - 2716693

<https://www.phoenixcontact.com/de/produkte/2716693>



Insertion bridge, pitch: 6.15 mm, color: red

 Max. current carrying capacity: 26 A

### Insertion bridge

Insertion bridge - EB 3- DIK RD - 2716745

<https://www.phoenixcontact.com/de/produkte/2716745>



Insertion bridge, pitch: 6.15 mm, color: red

 Max. current carrying capacity: 26 A

# Solid-state relay terminal block - DEK-OE- 24DC/ 24DC/100KHZ

2964283

<https://www.phoenixcontact.com/de/produkte/2964283>

## Insertion bridge

Insertion bridge - EB 4- DIK RD - 2716758

<https://www.phoenixcontact.com/de/produkte/2716758>

Insertion bridge, pitch: 6.15 mm, color: red



 Max. current carrying capacity: 26 A

---

## Insertion bridge

Insertion bridge - EB 5- DIK RD - 2716761

<https://www.phoenixcontact.com/de/produkte/2716761>

Insertion bridge, pitch: 6.15 mm, color: red



 Max. current carrying capacity: 26 A

# Solid-state relay terminal block - DEK-OE- 24DC/ 24DC/100KHZ

2964283

<https://www.phoenixcontact.com/de/produkte/2964283>

## Insertion bridge

Insertion bridge - EB 10- DIK RD - 2716774

<https://www.phoenixcontact.com/de/produkte/2716774>



Insertion bridge, pitch: 6.15 mm, color: red

 Max. current carrying capacity: 26 A

---

## Insertion bridge

Insertion bridge - EB 2- DIK BU - 2716648

<https://www.phoenixcontact.com/de/produkte/2716648>



Insertion bridge, pitch: 6.15 mm, color: blue

 Max. current carrying capacity: 26 A

# Solid-state relay terminal block - DEK-OE- 24DC/ 24DC/100KHZ

2964283

<https://www.phoenixcontact.com/de/produkte/2964283>

## Insertion bridge

Insertion bridge - EB 3- DIK BU - 2716651

<https://www.phoenixcontact.com/de/produkte/2716651>

Insertion bridge, pitch: 6.15 mm, color: blue



 Max. current carrying capacity: 26 A

---

## Insertion bridge

Insertion bridge - EB 4- DIK BU - 2716664

<https://www.phoenixcontact.com/de/produkte/2716664>

Insertion bridge, pitch: 6.15 mm, color: blue



 Max. current carrying capacity: 26 A

# Solid-state relay terminal block - DEK-OE- 24DC/ 24DC/100KHZ

2964283

<https://www.phoenixcontact.com/de/produkte/2964283>

## Insertion bridge

Insertion bridge - EB 5- DIK BU - 2716677

<https://www.phoenixcontact.com/de/produkte/2716677>



Insertion bridge, pitch: 6.15 mm, color: blue

 Max. current carrying capacity: 26 A

---

## Insertion bridge

Insertion bridge - EB 10- DIK BU - 2716680

<https://www.phoenixcontact.com/de/produkte/2716680>



Insertion bridge, pitch: 6.15 mm, color: blue

 Max. current carrying capacity: 26 A

# Solid-state relay terminal block - DEK-OE- 24DC/ 24DC/100KHZ

2964283

<https://www.phoenixcontact.com/de/produkte/2964283>

## Insertion bridge

Insertion bridge - EB 80- DIK BU - 2715940

<https://www.phoenixcontact.com/de/produkte/2715940>



Insertion bridge, pitch: 6.2 mm, color: blue

 Max. current carrying capacity: 26 A

---

## Insertion bridge

Insertion bridge - EB 80- DIK RD - 2715953

<https://www.phoenixcontact.com/de/produkte/2715953>



Insertion bridge, pitch: 6.2 mm, color: red

 Max. current carrying capacity: 26 A

# Solid-state relay terminal block - DEK-OE- 24DC/ 24DC/100KHZ

2964283

<https://www.phoenixcontact.com/de/produkte/2964283>

## Insertion bridge

Insertion bridge - EB 80- DIK WH - 2715788

<https://www.phoenixcontact.com/de/produkte/2715788>

Insertion bridge, pitch: 6.15 mm, color: white



 Max. current carrying capacity: 26 A

---

## Separating plate

Separating plate - D-DEK 1,5 GN - 2716949

<https://www.phoenixcontact.com/de/produkte/2716949>

Cover for setting the end of a terminal row, color: green

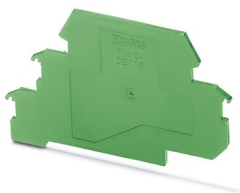

# Solid-state relay terminal block - DEK-OE- 24DC/ 24DC/100KHZ

2964283

<https://www.phoenixcontact.com/de/produkte/2964283>

## Sensor/actuator terminal block

Sensor/actuator terminal block - DIKD 1,5 - 2715979

<https://www.phoenixcontact.com/de/produkte/2715979>

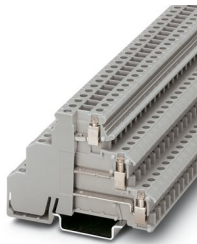

Sensor/actuator terminal block, nom. voltage: 250 V, nominal current: 24 A, connection method: Screw connection, 1st, 2nd and 3rd level, Rated cross section: 2.5 mm<sup>2</sup>, cross section: 0.2 mm<sup>2</sup> - 4 mm<sup>2</sup>, mounting type: NS 35/7,5, NS 35/15, color: gray

---

## Zack marker strip

Zack marker strip - ZB 6:UNBEDRUCKT - 1051003

<https://www.phoenixcontact.com/de/produkte/1051003>



Zack marker strip, Strip, white, unlabeled, can be labeled with: PLOTMARK, CMS-P1-PLOTTER, mounting type: snapped, for terminal block width: 6.2 mm, lettering field size: 6.15 x 10.5 mm, Number of individual labels: 10



# Solid-state relay terminal block - DEK-OE- 24DC/ 24DC/100KHZ



2964283

<https://www.phoenixcontact.com/de/produkte/2964283>

## Zack marker strip

Zack marker strip - ZB 6,LGS:FORTL.ZAHLEN - 1051016

<https://www.phoenixcontact.com/de/produkte/1051016>



Zack marker strip, Strip, white, labeled, can be labeled with: CMS-P1-PLOTTER, printed horizontally: consecutive numbers 1 ... 10, 11 ... 20, etc. up to 491 ... 500, mounting type: snapped, for terminal block width: 6.2 mm, lettering field size: 6.15 x 10.5 mm, Number of individual labels: 10

## Zack marker strip

Zack marker strip - ZB 6/WH-100:UNBEDRUCKT - 5060935

<https://www.phoenixcontact.com/de/produkte/5060935>



Zack marker strip, Strip, white, unlabeled, can be labeled with: PLOTMARK, CMS-P1-PLOTTER, mounting type: snapped, for terminal block width: 6.2 mm, lettering field size: 6.15 x 10.5 mm, Number of individual labels: 1000

Phoenix Contact 2022 © - all rights reserved

<https://www.phoenixcontact.com>

PHOENIX CONTACT Deutschland GmbH

Flachsmarktstraße 8

D-32825 Blomberg

+49 52 35/3-1 20 00

[info@phoenixcontact.de](mailto:info@phoenixcontact.de)