

PCB connector - MSTB 2,5/12-ST

1754643

<https://www.phoenixcontact.com/de/produkte/1754643>

Please be informed that the data shown in this PDF document is generated from our Online Catalog. Please find the complete data in the user documentation. Our General Terms of Use for Downloads are valid.



PCB connector, nominal cross section: 2.5 mm², color: green, nominal current: 12 A, rated voltage (III/2): 320 V, contact surface: Tin, type of contact: Female connector, number of potentials: 12, number of rows: 1, number of positions: 12, number of connections: 12, product range: MSTB 2,5/...-ST, pitch: 5 mm, connection method: Screw connection with tension sleeve, screw head form: L Slotted, conductor/PCB connection direction: 0 °, locking clip: - Locking clip, plug-in system: COMBICON MSTB 2,5, locking: without, mounting: without, type of packaging: packed in cardboard

Your advantages

- Well-known connection principle allows worldwide use
- Low temperature rise, thanks to maximum contact force
- Allows connection of two conductors

PCB connector - MSTB 2,5/12-ST



1754643

<https://www.phoenixcontact.com/de/produkte/1754643>

Commercial Data

| | |
|--------------------------------------|---------------------------|
| Item number | 1754643 |
| Packing unit | 50 pc |
| Minimum order quantity | 50 pc |
| Sales Key | E1 - Leiterplattenanschl. |
| Product Key | AACAFC |
| Catalog Page | Page 262 (C-1-2013) |
| GTIN | 4017918028817 |
| Weight per Piece (including packing) | 20,97 g |
| Weight per Piece (excluding packing) | 19,882 g |
| Customs tariff number | 85366990 |
| Country of origin | DE |

1754643

<https://www.phoenixcontact.com/de/produkte/1754643>

Technical Data

Product properties

| | |
|-----------------------|-----------------------|
| Type | Standard |
| Product line | COMBICON Connectors M |
| Product type | PCB plug |
| Number of positions | 12 |
| Pitch | 5 mm |
| Number of connections | 12 |
| Number of rows | 1 |
| Mounting flange | without |
| Number of potentials | 12 |

Electrical properties

| | |
|-----------------------------|--------|
| Nominal current I_N | 12 A |
| Nominal voltage U_N | 320 V |
| Pollution degree | 3 |
| Contact resistance | 1.4 mΩ |
| Rated voltage (III/3) | 250 V |
| Rated surge voltage (III/3) | 4 kV |
| Rated voltage (III/2) | 320 V |
| Rated surge voltage (III/2) | 4 kV |

Connection data

Connection technology

| | |
|-----------------------|---------------------|
| Type | Standard |
| Connector system | COMBICON MSTB 2,5 |
| Nominal cross section | 2.5 mm ² |
| Type of contact | Female connector |

Interlock

| | |
|-----------------|---------|
| Locking type | without |
| Mounting flange | without |

Conductor connection

| | |
|---|--|
| Connection method | Screw connection with tension sleeve |
| Conductor/PCB connection direction | 0 ° |
| Conductor cross section solid | 0.2 mm ² ... 2.5 mm ² |
| Conductor cross section flexible | 0.2 mm ² ... 2.5 mm ² |
| Conductor cross section AWG | 24 ... 12 |
| Conductor cross section flexible, with ferrule without plastic sleeve | 0.25 mm ² ... 2.5 mm ² |
| Conductor cross section, flexible, with ferrule, with plastic sleeve | 0.25 mm ² ... 2.5 mm ² |
| 2 conductors with same cross section, solid | 0.2 mm ² ... 1 mm ² |

PCB connector - MSTB 2,5/12-ST

1754643

<https://www.phoenixcontact.com/de/produkte/1754643>

| | |
|---|---|
| 2 conductors with same cross section, flexible | 0.2 mm ² ... 1.5 mm ² |
| 2 conductors with same cross section, flexible, with ferrule without plastic sleeve | 0.25 mm ² ... 1 mm ² |
| 2 conductors with the same cross section, flexible, with TWIN ferrule with plastic sleeve | 0.5 mm ² ... 1.5 mm ² |
| Cylindrical gauge a x b / diameter | 2.8 mm x 2.0 mm / 2.4 mm |
| Stripping length | 7 mm |
| Torque | 0.5 Nm ... 0.6 Nm |

Material specifications

Material data - contact

| | |
|--|--|
| Note | WEEE/RoHS-compliant, free of whiskers according to IEC 60068-2-82/JEDEC JESD 201 |
| Contact material | Cu alloy |
| Surface characteristics | hot-dip tin-plated |
| Metal surface terminal point (top layer) | Tin (5 - 7 µm Sn) |
| Metal surface contact area (top layer) | Tin (5 - 7 µm Sn) |

Material data - housing

| | |
|---|--------------|
| Housing color | green (6021) |
| Insulating material | PA |
| Insulating material group | I |
| CTI according to IEC 60112 | 600 |
| Flammability rating according to UL 94 | V0 |
| Glow wire flammability index GWFI according to EN 60695-2-12 | 850 |
| Glow wire ignition temperature GWIT according to EN 60695-2-13 | 775 |
| Temperature for the ball pressure test according to EN 60695-10-2 | 125 °C |

Dimensions

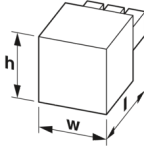
| | |
|---------------------|--|
| Dimensional drawing |  |
| Pitch | 5 mm |
| Width [w] | 60 mm |
| Height [h] | 15 mm |
| Length [l] | 18.2 mm |
| Installed height | 15 mm |

Mounting

| | |
|-----------------------|-------------|
| Drive form screw head | Slotted (L) |
|-----------------------|-------------|

Notes

| | |
|--------------------|--|
| Notes on operation | In accordance with IEC 61984, COMBICON connectors have no switching power (COC). During designated use, they must not be plugged in or disconnected when carrying voltage or under load. |
|--------------------|--|

Mechanical tests

Test for conductor damage and slackening

| | |
|---------------|---------------------|
| Specification | IEC 60999-1:1999-11 |
| Result | Test passed |

Pull-out test

| | |
|---|---|
| Specification | IEC 60999-1:1999-11 |
| Conductor cross section/conductor type/tractive force setpoint/actual value | 0.2 mm ² / solid / > 10 N |
| | 0.2 mm ² / flexible / > 10 N |
| | 2.5 mm ² / solid / > 50 N |
| | 2.5 mm ² / flexible / > 50 N |

Insertion and withdrawal forces

| | |
|-------------------------------------|-------------|
| Result | Test passed |
| No. of cycles | 25 |
| Insertion strength per pos. approx. | 8 N |
| Withdraw strength per pos. approx. | 6 N |

Torque test

| | |
|---------------|---------------------|
| Specification | IEC 60999-1:1999-11 |
|---------------|---------------------|

Contact holder in insert

| | |
|---|------------------------|
| Specification | IEC 60512-15-1:2008-05 |
| Contact holder in insert Requirements >20 N | Test passed |

Resistance of inscriptions

| | |
|---------------|------------------------|
| Specification | IEC 60068-2-70:1995-12 |
| Result | Test passed |

Polarization and coding

| | |
|---------------|------------------------|
| Specification | IEC 60512-13-5:2006-02 |
| Result | Test passed |

Visual inspection

| | |
|---------------|-----------------------|
| Specification | IEC 60512-1-1:2002-02 |
| Result | Test passed |

Dimension check

| | |
|---------------|-----------------------|
| Specification | IEC 60512-1-2:2002-02 |
| Result | Test passed |

Environmental and real-life conditions

Vibration test

| | |
|------------------------|------------------------|
| Specification | IEC 60068-2-6:2007-12 |
| Frequency | 10 - 150 - 10 Hz |
| Sweep speed | 1 octave/min |
| Amplitude | 0.35 mm (10 - 60.1 Hz) |
| Sweep speed | 5g (60.1 - 150 Hz) |
| Test duration per axis | 2.5 h |

Durability test

| | |
|--|-----------------------|
| Specification | IEC 60512-9-1:2010-03 |
| Impulse withstand voltage at sea level | 4.8 kV |
| Contact resistance R_1 | 1.4 m Ω |
| Contact resistance R_2 | 1.5 m Ω |
| Insertion/withdrawal cycles | 25 |
| Insulation resistance, neighboring positions | > 5 M Ω |

Climatic test

| | |
|-----------------------------------|---|
| Specification | ISO 6988:1985-02 |
| Corrosive stress | 0.2 dm ³ SO ₂ on 300 dm ³ /40 °C/1 cycle |
| Thermal stress | 100 °C/168 h |
| Power-frequency withstand voltage | 2.21 kV |

Ambient conditions

| | |
|---|---|
| Ambient temperature (operation) | -40 °C ... 100 °C (dependent on the derating curve) |
| Ambient temperature (storage/transport) | -40 °C ... 70 °C |
| Relative humidity (storage/transport) | 30 % ... 70 % |
| Ambient temperature (assembly) | -5 °C ... 100 °C |

Electrical tests

Thermal test | Test group C

| | |
|----------------------------|-----------------------|
| Specification | IEC 60512-5-1:2002-02 |
| Tested number of positions | 24 |

Insulation resistance

| | |
|--|-----------------------|
| Specification | IEC 60512-3-1:2002-02 |
| Insulation resistance, neighboring positions | > 5 M Ω |

Air clearances and creepage distances |

| | |
|--|---------------------|
| Specification | IEC 60664-1:2007-04 |
| Insulating material group | I |
| Comparative tracking index (IEC 60112) | CTI 600 |
| Rated insulation voltage (III/3) | 250 V |
| Rated surge voltage (III/3) | 4 kV |

PCB connector - MSTB 2,5/12-ST



1754643

<https://www.phoenixcontact.com/de/produkte/1754643>

| | |
|--|--------|
| minimum clearance value - non-homogenous field (III/3) | 3 mm |
| minimum creepage distance (III/3) | 3.2 mm |
| Rated insulation voltage (III/2) | 320 V |
| Rated surge voltage (III/2) | 4 kV |
| minimum clearance value - non-homogenous field (III/2) | 3 mm |
| minimum creepage distance (III/2) | 3 mm |
| Rated insulation voltage (II/2) | 630 V |
| Rated surge voltage (II/2) | 4 kV |
| minimum clearance value - non-homogenous field (II/2) | 3 mm |
| minimum creepage distance (II/2) | 3.2 mm |

Packaging specifications

| | |
|-------------------|---------------------|
| Type of packaging | packed in cardboard |
|-------------------|---------------------|

Drawings

Diagram

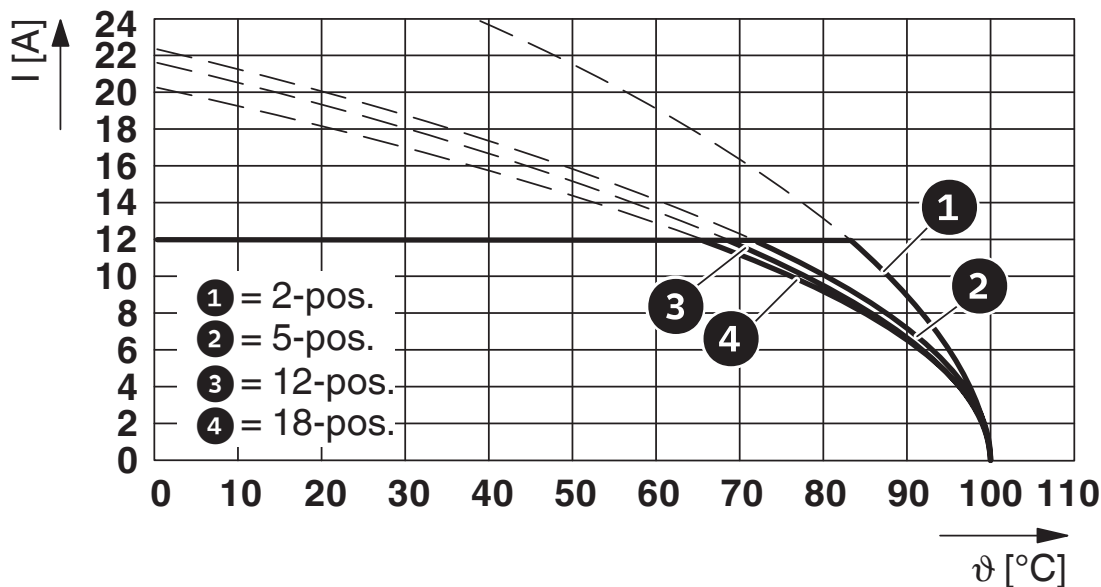

Type: MSTB 2,5/...-ST with FKIC 2,5/...-ST

Diagram

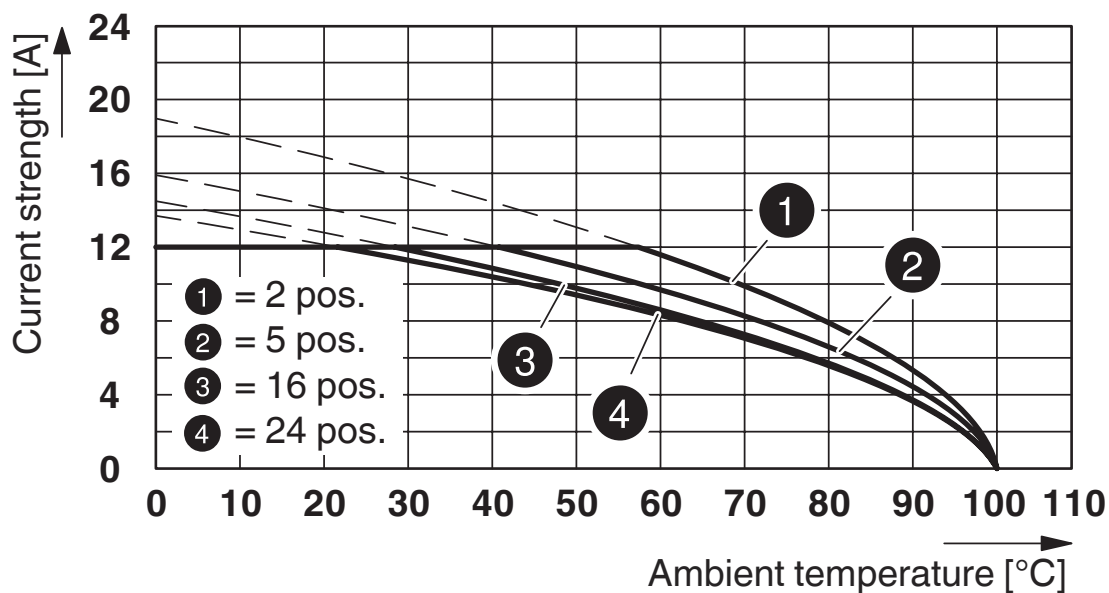

Type: MSTB 2,5/...-ST with MSTBV 2,5/...-G

1754643

<https://www.phoenixcontact.com/de/produkte/1754643>

Diagram

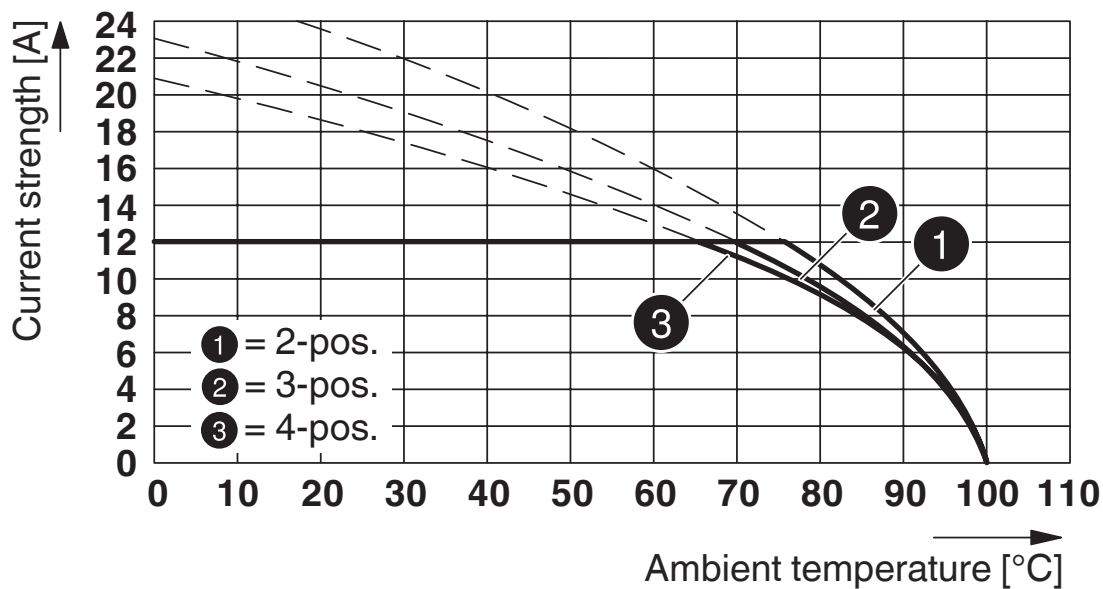

Type: MSTB 2,5/...-ST with MSTBO 2,5/...-G1L

Diagram

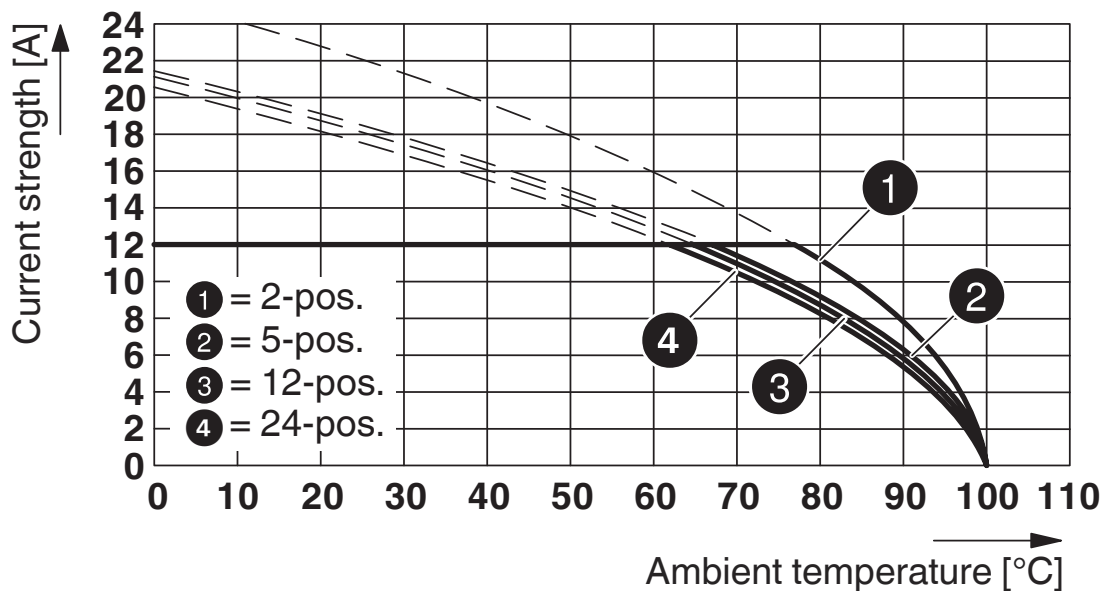

Type: MSTB 2,5/...-ST with MSTBA 2,5/...-G

1754643

<https://www.phoenixcontact.com/de/produkte/1754643>

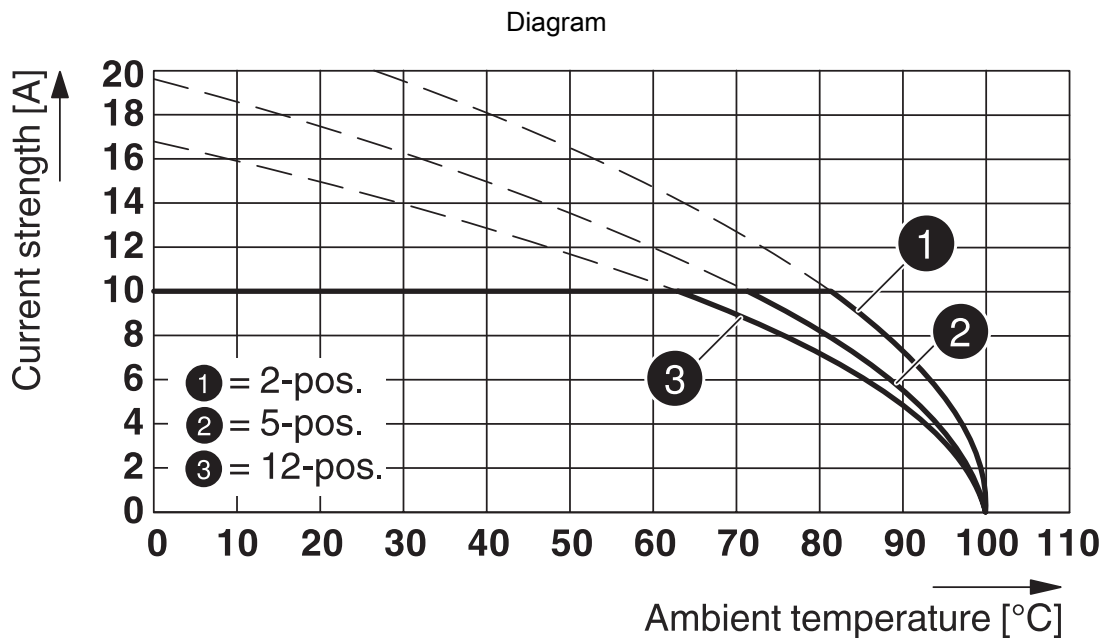

Type: MSTB 2,5/...-ST with MDSTBW 2,5/...-G

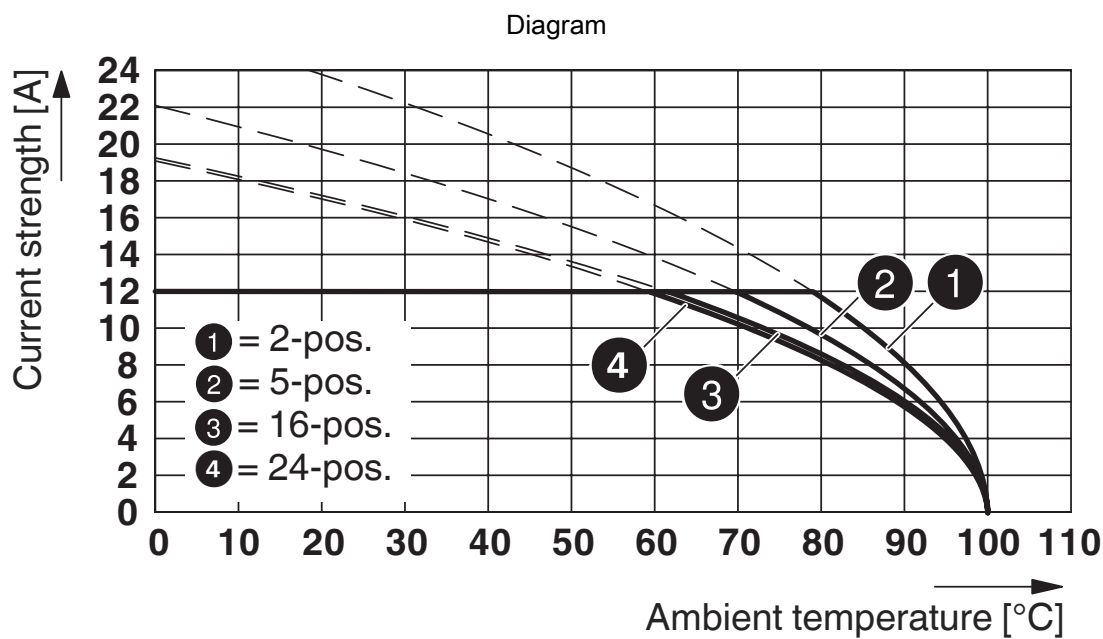

Type: MSTB 2,5/...-ST with SMSTBA 2,5/...-G

1754643

<https://www.phoenixcontact.com/de/produkte/1754643>

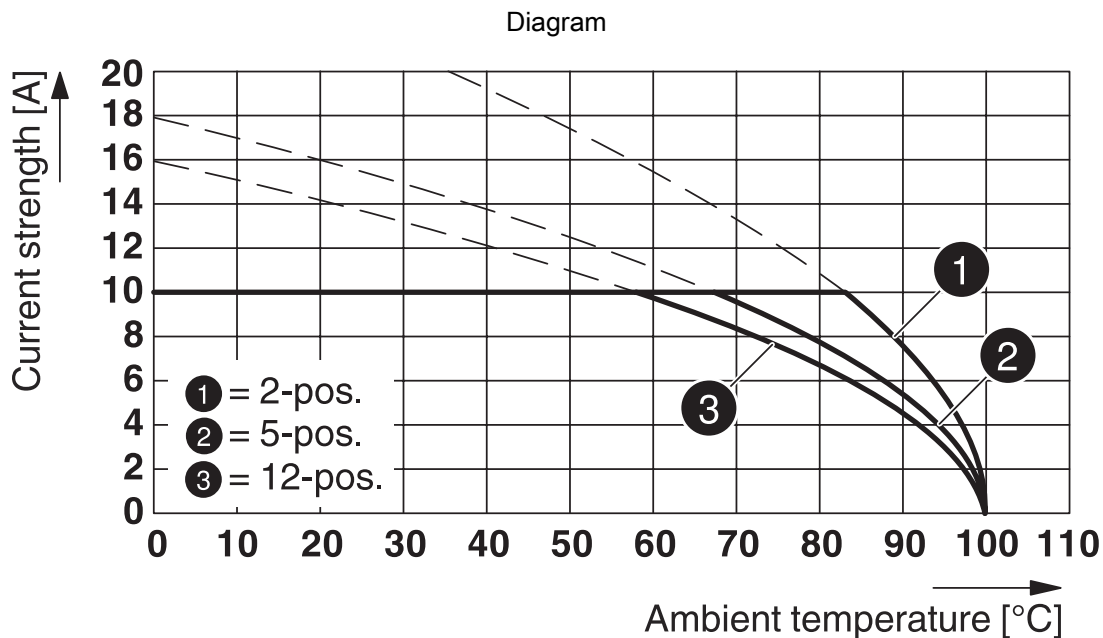

Type: MSTB 2,5/...-ST with MDSTB 2,5/...-G

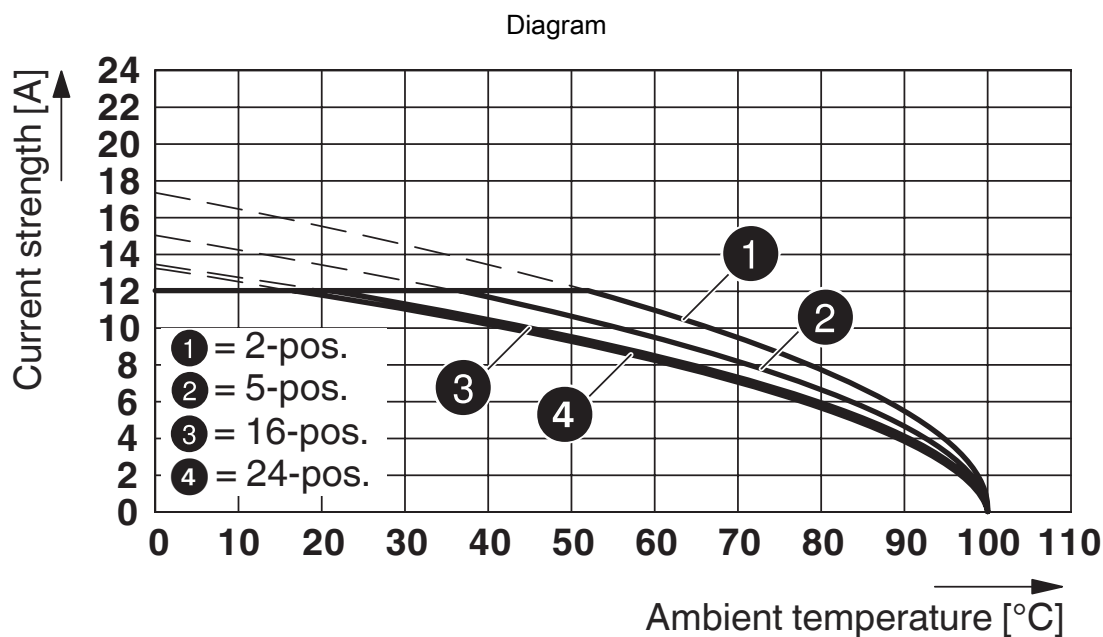

Type: MSTB 2,5/...-ST with MSTBVA 2,5/...-G

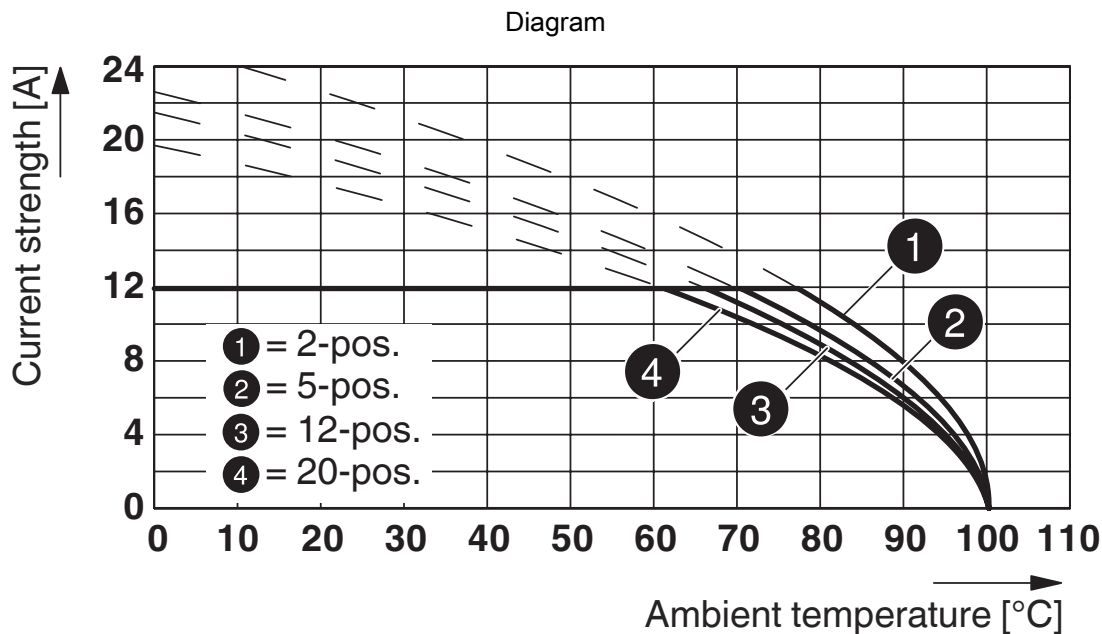

Type: MSTB 2,5/...-ST with MSTBW 2,5/...-G

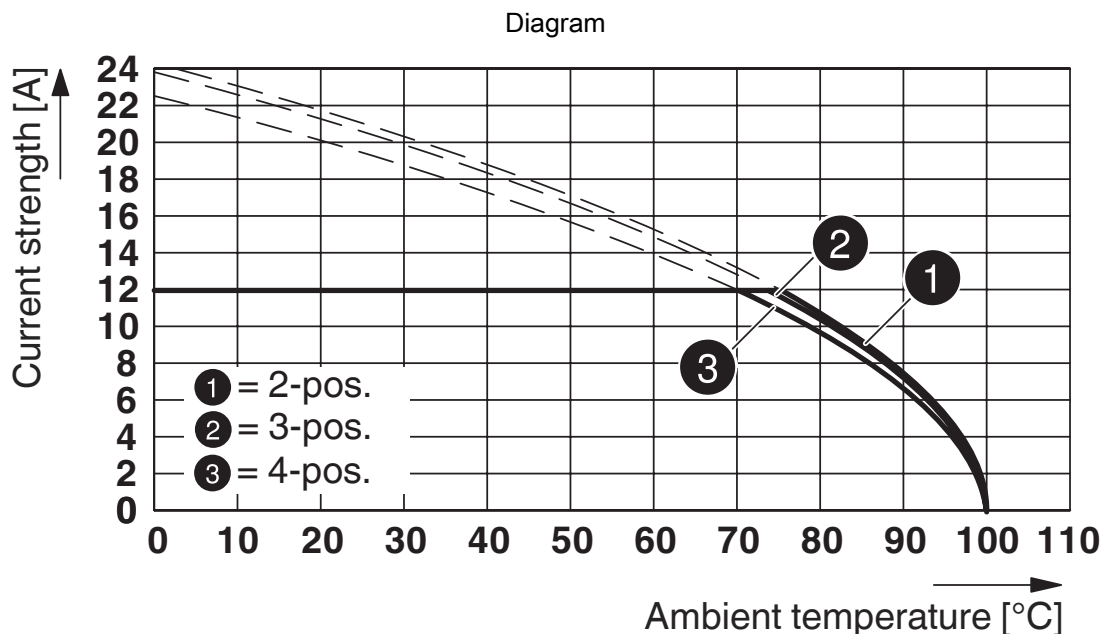

Type: MSTB 2,5/...-ST with MSTBO 2,5/...-G1R

1754643

<https://www.phoenixcontact.com/de/produkte/1754643>

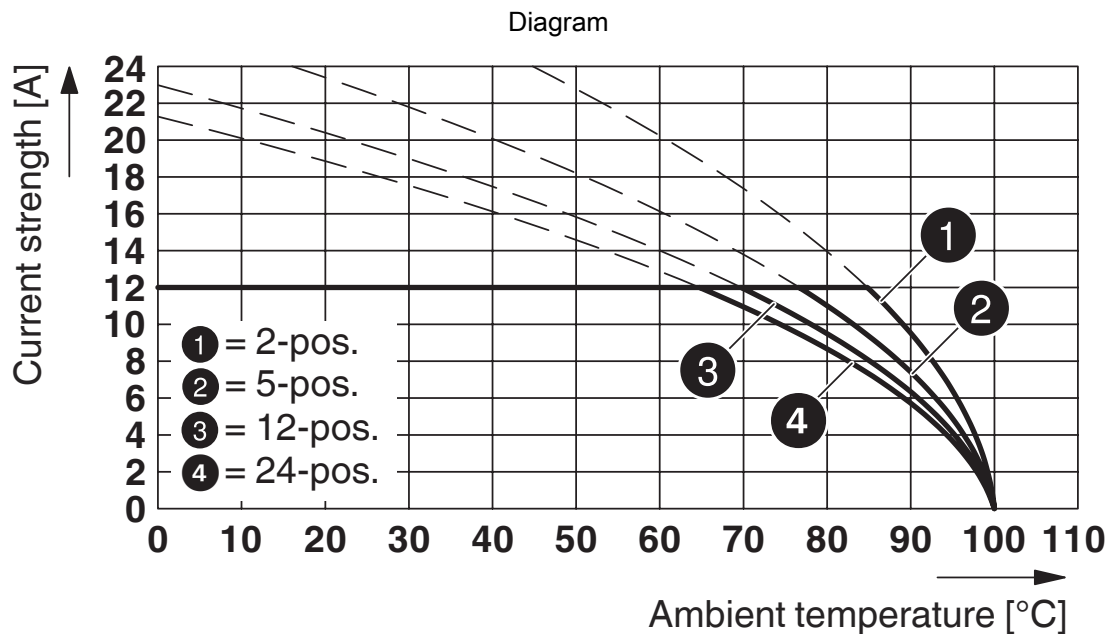

Type: MSTB 2,5/...-ST with CCA 2,5/...-G P20 THR

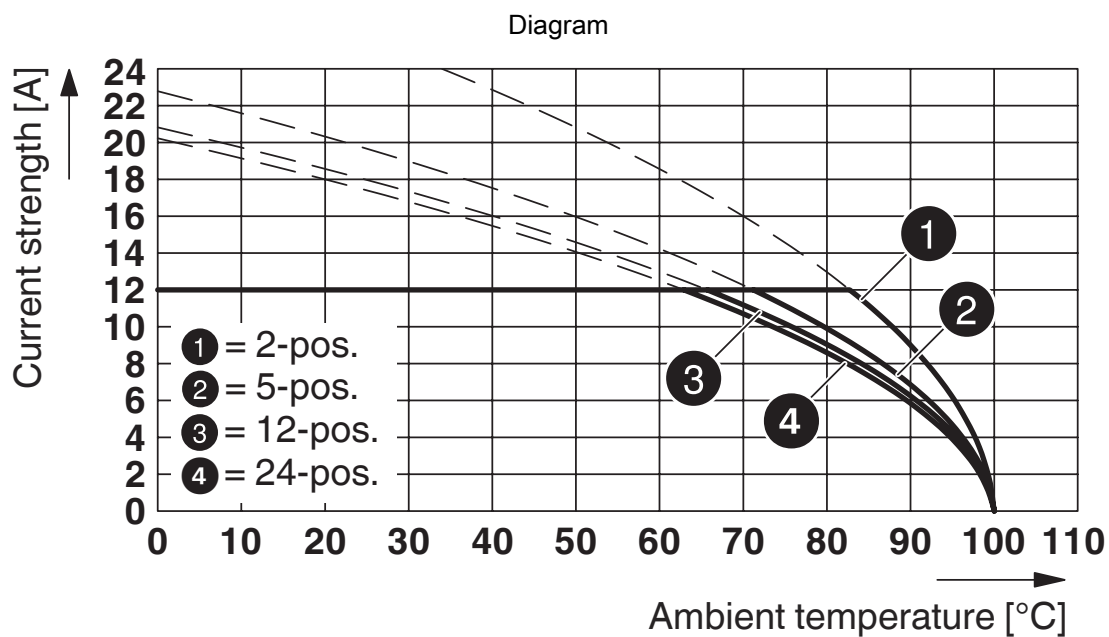

Type: MSTB 2,5/...-ST with CCVA 2,5/...-G P20 THR

PCB connector - MSTB 2,5/12-ST



1754643

<https://www.phoenixcontact.com/de/produkte/1754643>

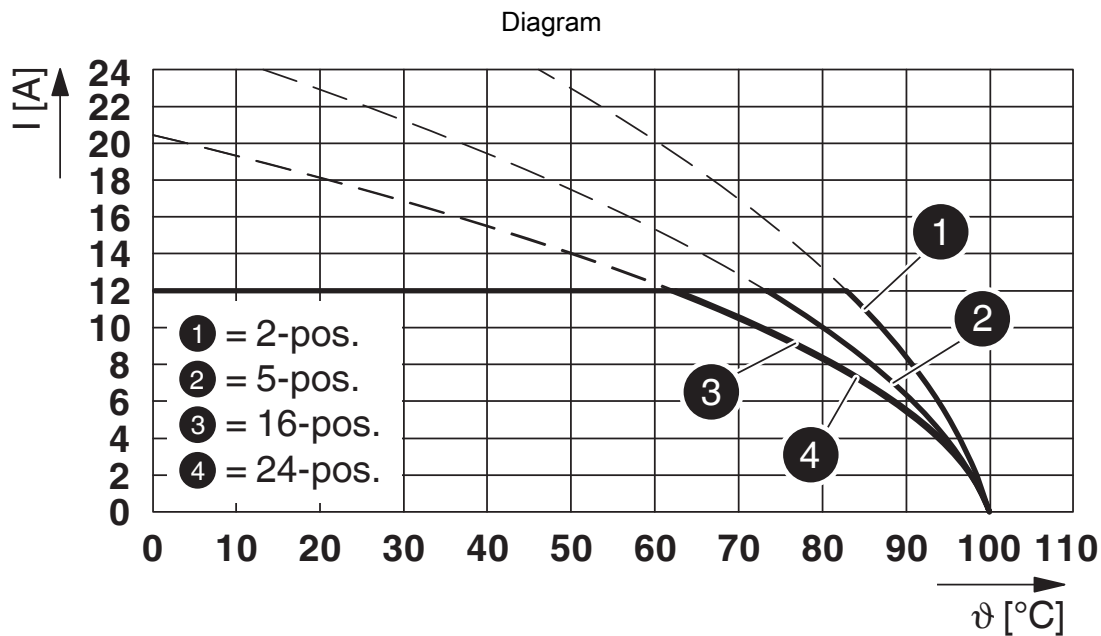

Type: MSTB 2,5/...-ST with MSTB 2,5/...-G

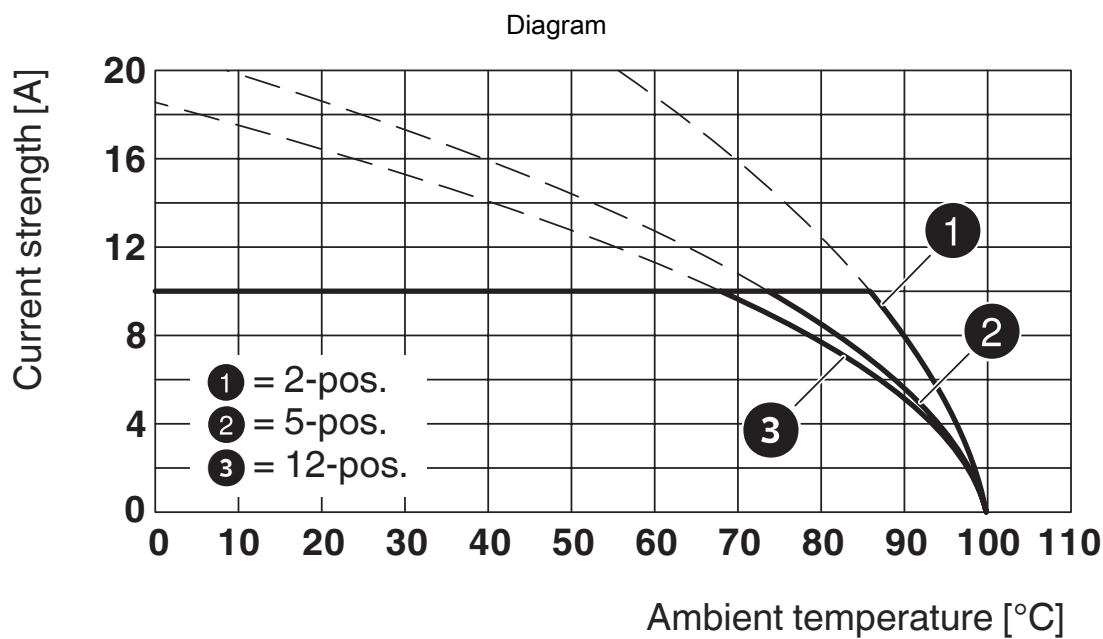

Type: MSTB 2,5/...-ST with MDSTBV 2,5/...-G

PCB connector - MSTB 2,5/12-ST

1754643

<https://www.phoenixcontact.com/de/produkte/1754643>

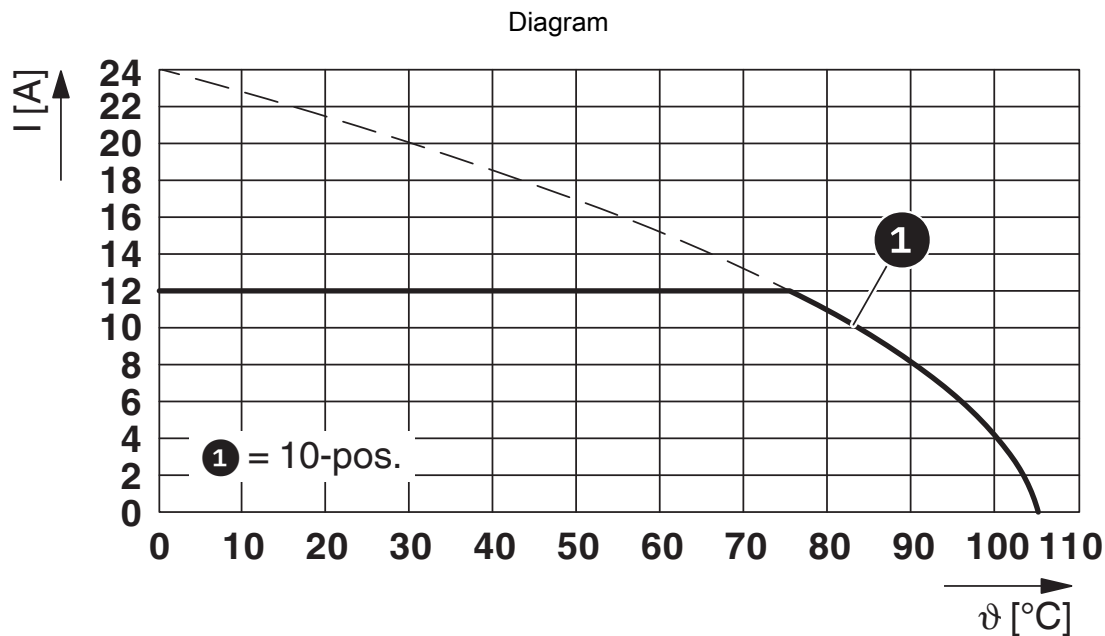

Type: MSTB 2,5/...-ST with MSTBHK 2,5/...-G

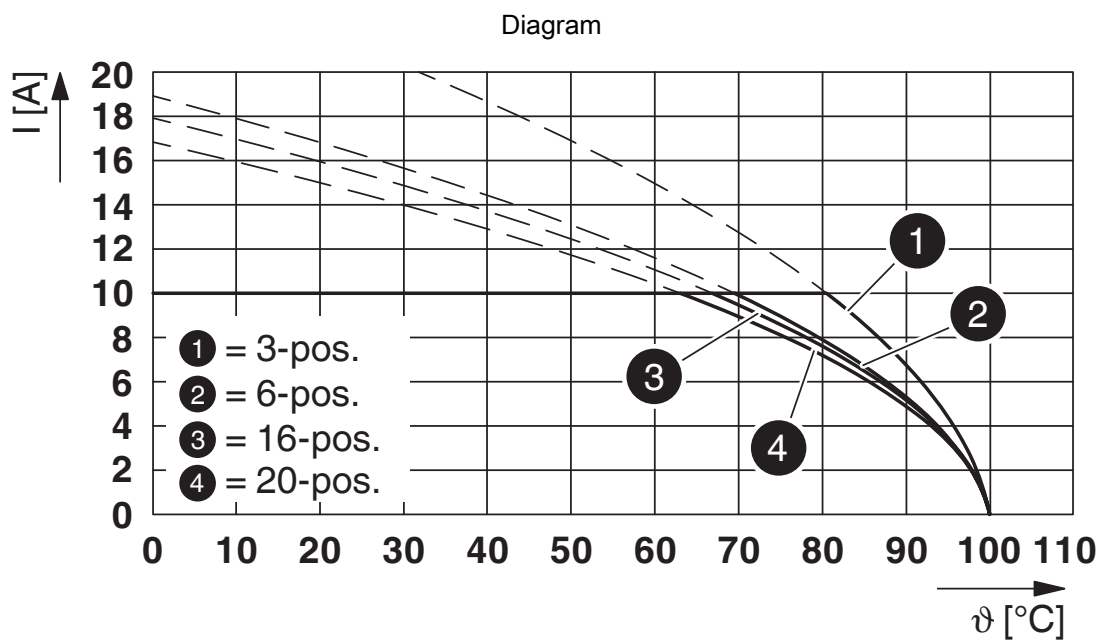

Type: MSTB 2,5/...-ST with MDSTB 2,5/...-G1

PCB connector - MSTB 2,5/12-ST



1754643

<https://www.phoenixcontact.com/de/produkte/1754643>

Approvals

|  CSA Approval ID: LR13631-2585950 | | | | |
|--|-----------------------|-----------------------|-------------------|-----------------------------|
| | Nominal Voltage U_N | Nominal Current I_N | Cross Section AWG | Cross Section mm^2 |
| Use group B | 300 V | 15 A | 28 - 12 | - |
| Use group D | 300 V | 10 A | 28 - 12 | - |

|  IECEE CB Scheme Approval ID: DE1-60988-B1B2 | | | | |
|---|-----------------------|-----------------------|-------------------|-----------------------------|
| | Nominal Voltage U_N | Nominal Current I_N | Cross Section AWG | Cross Section mm^2 |
| | 250 V | 12 A | - | 0.2 - 2.5 |

|  EAC Approval ID: B.01687 | | | | |
|--|--|--|--|--|
|--|--|--|--|--|

|  cULus Recognized Approval ID: E60425-19931011 | | | | |
|---|-----------------------|-----------------------|-------------------|-----------------------------|
| | Nominal Voltage U_N | Nominal Current I_N | Cross Section AWG | Cross Section mm^2 |
| Use group B | 300 V | 15 A | 30 - 12 | - |
| Use group D | 300 V | 10 A | 30 - 12 | - |

|  VDE Zeichengenehmigung Approval ID: 40004701 | | | | |
|--|-----------------------|-----------------------|-------------------|-----------------------------|
| | Nominal Voltage U_N | Nominal Current I_N | Cross Section AWG | Cross Section mm^2 |
| | 250 V | 12 A | - | 0.2 - 2.5 |

PCB connector - MSTB 2,5/12-ST



1754643

<https://www.phoenixcontact.com/de/produkte/1754643>

Classifications

ECLASS

| | |
|---------------|----------|
| ECLASS-9.0 | 27440309 |
| ECLASS-10.0.1 | 27440309 |
| ECLASS-11.0 | 27460202 |

ETIM

| | |
|----------|----------|
| ETIM 8.0 | EC002638 |
|----------|----------|

UNSPSC

| | |
|-------------|----------|
| UNSPSC 21.0 | 39121400 |
|-------------|----------|

PCB connector - MSTB 2,5/12-ST



1754643

<https://www.phoenixcontact.com/de/produkte/1754643>

Environmental Product Compliance

| | |
|------------|--|
| REACH SVHC | Lead 7439-92-1 |
| China RoHS | Environmentally Friendly Use Period = 50 years |
| | For information on hazardous substances, refer to the manufacturer's declaration available under "Downloads" |

PCB connector - MSTB 2,5/12-ST

1754643

<https://www.phoenixcontact.com/de/produkte/1754643>

Accessories

Screwdriver

Screwdriver - SZS 0,6X3,5 - 1205053

<https://www.phoenixcontact.com/de/produkte/1205053>



Actuation tool, for ST terminal blocks, insulated, also suitable for use as a bladed screwdriver, size: 0.6 x 3.5 x 100 mm, 2-component grip, with non-slip grip

Marker card

Marker card - SK 5/3,8:FORTL.ZAHLEN - 0804183

<https://www.phoenixcontact.com/de/produkte/0804183>



Marker card, white, labeled, horizontal: consecutive numbers 1 ... 10, 11 ... 20, etc. up to 91 ... (99)100, mounting type: adhesive, for terminal block width: 5 mm, lettering field size: 5 x 3.8 mm

PCB connector - MSTB 2,5/12-ST

1754643

<https://www.phoenixcontact.com/de/produkte/1754643>

Cable housing

Cable housing - KGS-MSTB 2,5/12 - 1783818

<https://www.phoenixcontact.com/de/produkte/1783818>



Cable housing, pitch: 0 mm, number of positions: 12, dimension a: 60 mm, color: green

Coding profile

Coding profile - CP-MSTB - 1734634

<https://www.phoenixcontact.com/de/produkte/1734634>



Coding profile, is inserted into the slot on the plug or inverted header, red insulating material

PCB connector - MSTB 2,5/12-ST

1754643

<https://www.phoenixcontact.com/de/produkte/1754643>

Insertion bridge

Insertion bridge - EBP 2- 5 - 1733169

<https://www.phoenixcontact.com/de/produkte/1733169>

Insertion bridge for connectors with 5.0 mm or 5.08 mm pitch



PCB header

PCB header - MSTBW 2,5/12-G - 1736014

<https://www.phoenixcontact.com/de/produkte/1736014>

PCB headers, nominal cross section: 2.5 mm², color: green, nominal current: 12 A, rated voltage (III/2): 320 V, contact surface: Tin, type of contact: Male connector, number of potentials: 12, number of rows: 1, number of positions: 12, number of connections: 12, product range: MSTBW 2,5/..-G, pitch: 5 mm, pin layout: Linear pinning, solder pin [P]: 3.5 mm, number of solder pins per potential: 1, plug-in system: COMBICON MSTB 2,5, Pin connector pattern alignment: Standard, locking: without, mounting: without, type of packaging: packed in cardboard

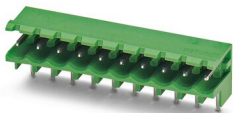

PCB connector - MSTB 2,5/12-ST

1754643

<https://www.phoenixcontact.com/de/produkte/1754643>

PCB header

PCB header - MSTBV 2,5/12-G - 1753631

<https://www.phoenixcontact.com/de/produkte/1753631>

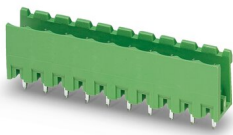

PCB headers, nominal cross section: 2.5 mm², color: green, nominal current: 12 A, rated voltage (III/2): 320 V, contact surface: Tin, type of contact: Male connector, number of potentials: 12, number of rows: 1, number of positions: 12, number of connections: 12, product range: MSTBV 2,5/..-G, pitch: 5 mm, pin layout: Linear pinning, solder pin [P]: 3.9 mm, number of solder pins per potential: 1, plug-in system: COMBICON MSTB 2,5, Pin connector pattern alignment: Standard, locking: without, mounting: without, type of packaging: packed in cardboard

PCB header

PCB header - MDSTBV 2,5/12-G - 1846030

<https://www.phoenixcontact.com/de/produkte/1846030>

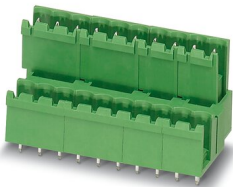

PCB headers, nominal cross section: 2.5 mm², color: green, nominal current: 10 A, rated voltage (III/2): 320 V, contact surface: Tin, type of contact: Male connector, number of potentials: 24, number of rows: 2, number of positions: 12, number of connections: 24, product range: MDSTBV 2,5/..-G, pitch: 5 mm, pin layout: Linear pinning, solder pin [P]: 3.5 mm, number of solder pins per potential: 1, plug-in system: COMBICON MSTB 2,5, Pin connector pattern alignment: Standard, locking: without, mounting: without, type of packaging: packed in cardboard, Can be aligned! Mounting flange: Item No. 1836477, 1836480. In combination with MVSTB or FKCV plug components, both an MVSTBW (or FKCVW) and an MVSTBR plug (or FKCVR) must be used. Combination with TMSTBP plug components is not possible!

PCB connector - MSTB 2,5/12-ST

1754643

<https://www.phoenixcontact.com/de/produkte/1754643>

PCB header

PCB header - MDSTB 2,5/12-G - 1846467

<https://www.phoenixcontact.com/de/produkte/1846467>



PCB headers, nominal cross section: 2.5 mm², color: green, nominal current: 10 A, rated voltage (III/2): 320 V, contact surface: Tin, type of contact: Male connector, number of potentials: 24, number of rows: 2, number of positions: 12, number of connections: 24, product range: MDSTB 2,5/..-G, pitch: 5 mm, pin layout: Linear pinning, solder pin [P]: 3.2 mm, number of solder pins per potential: 1, plug-in system: COMBICON MSTB 2,5, Pin connector pattern alignment: Standard, locking: without, mounting: without, type of packaging: packed in cardboard, Can be aligned! Mounting flange: Item No. 1736771, 1736768. In combination with MVSTB or FKCV plug components, both an MVSTBW (or FKCVW) and an MVSTBR plug (or FKCVR) must be used. Combination with TMSTBP plug components is not possible!

PCB header

PCB header - MDSTBA 2,5/12-G - 1846616

<https://www.phoenixcontact.com/de/produkte/1846616>

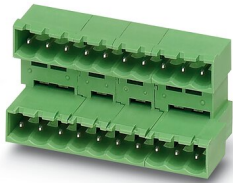

PCB headers, nominal cross section: 2.5 mm², color: green, nominal current: 10 A, rated voltage (III/2): 320 V, contact surface: Tin, type of contact: Male connector, number of potentials: 24, number of rows: 2, number of positions: 12, number of connections: 24, product range: MDSTBA 2,5/..-G, pitch: 5 mm, pin layout: Linear pinning, solder pin [P]: 3.2 mm, number of solder pins per potential: 1, plug-in system: COMBICON MSTB 2,5, Pin connector pattern alignment: Standard, locking: without, mounting: without, type of packaging: packed in cardboard, The article can be aligned to create different nos. of positions! In combination with MVSTB or FKCV plug components, both an MVSTBW (or FKCVW) and an MVSTBR plug (or FKCVR) must be used. Combination with TMSTBP plug components is not possible!