

Contact insert module - HC-M-12-PT-F



1424228

<https://www.phoenixcontact.com/pc/products/1424228>

Please be informed that the data shown in this PDF document is generated from our Online Catalog. Please find the complete data in the user documentation. Our General Terms of Use for Downloads are valid.



Contact insert module, number of positions: 12, power contacts: 0, control contacts: 12, Socket, Push-in connection, 250 V, 10 A, 0.14 mm² ... 1.5 mm², application: Signal

Your advantages

- Easy installation without tools, even when mounted, with push-in connection technology
- Shortest installation time compared to other connection technologies
- Quick and effortless wiring, in particular when space is tight
- Automatic cabling with robots possible
- Safe wiring and operation with color-coded actuators
- Shock and vibration-resistant in accordance with DIN EN 61373

Contact insert module - HC-M-12-PT-F



1424228

<https://www.phoenixcontact.com/pc/products/1424228>

Commercial Data

Item number	1424228
Packing unit	1 pc
Minimum order quantity	1 pc
Note	Made to Order (non-returnable)
Product Key	BF7ACE
Catalog Page	Page 577 (C-2-2019)
GTIN	4055626369594
Weight per Piece (including packing)	25.2 g
Weight per Piece (excluding packing)	24 g
Customs tariff number	85366990
Country of origin	PL

Contact insert module - HC-M-12-PT-F

1424228

<https://www.phoenixcontact.com/pc/products/1424228>

Technical Data

Notes

General	only use flexible conductors with ferrules
General	Connectors may be operated only when there is no load/voltage.
General	For HEAVYCON housing type B6 to B48, HC-M-B...MF-... hinged module carrier frame required.

Product properties

Product type	Modular contact insert
Number of positions	12
Connection profile	12
Application	Signal
Number of module slots	1
No. of power contacts	0
No. of control contacts	12
Contact type	turned
Series	HC-M-12

Insulation characteristics

Overvoltage category	III
Degree of pollution	3

Connection data

Connection technology

Connection technology	Push-in connection
-----------------------	--------------------

Conductor connection

Connection cross section AWG	26 ... 16
Stripping length of the individual wire	8 mm

Dimensions

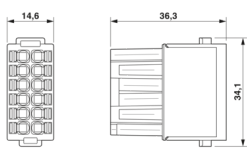
Dimensional drawing	
Width	34.1 mm
Height	36.3 mm
Length	14.6 mm

Mechanical characteristics

Contact diameter	1.6 mm
------------------	--------

Electrical properties

Contact insert module - HC-M-12-PT-F



1424228

<https://www.phoenixcontact.com/pc/products/1424228>

Rated voltage (III/2) contacts	400 V
Rated voltage (III/3)	250 V
Rated surge voltage (III/2)	4 kV
Rated surge voltage (III/3)	4 kV
Rated surge voltage	4 kV
Rated current	10 A

Material specifications

Color	light grey
Flammability rating according to UL 94	V0
Contact material	Copper alloy
Contact surface material	Ag
Contact carrier material	PC
Standards/regulations	PC: Fire protection in rail vehicles - requirement sets R22, R23, and R24 acc. to DIN EN 45545-2 (Risk level HL1 - HL3)

Connector

Insertion/withdrawal cycles	≥ 500
-----------------------------	-------

Cable / line

Cable structure

Stripping length of the individual wire	8 mm
---	------

Mounting

Assembly instructions	To ensure correct use, installation in housing with IP54 protection or better is required
-----------------------	---

Ambient conditions

Ambient temperature (operation)	-40 °C ... 125 °C
---------------------------------	-------------------

Standards and regulations

Testing

Standards/regulations	PC: Fire protection in rail vehicles - requirement sets R22, R23, and R24 acc. to DIN EN 45545-2 (Risk level HL1 - HL3)
-----------------------	---

Contact insert module - HC-M-12-PT-F



1424228

<https://www.phoenixcontact.com/pc/products/1424228>

Drawings

Schematic diagram

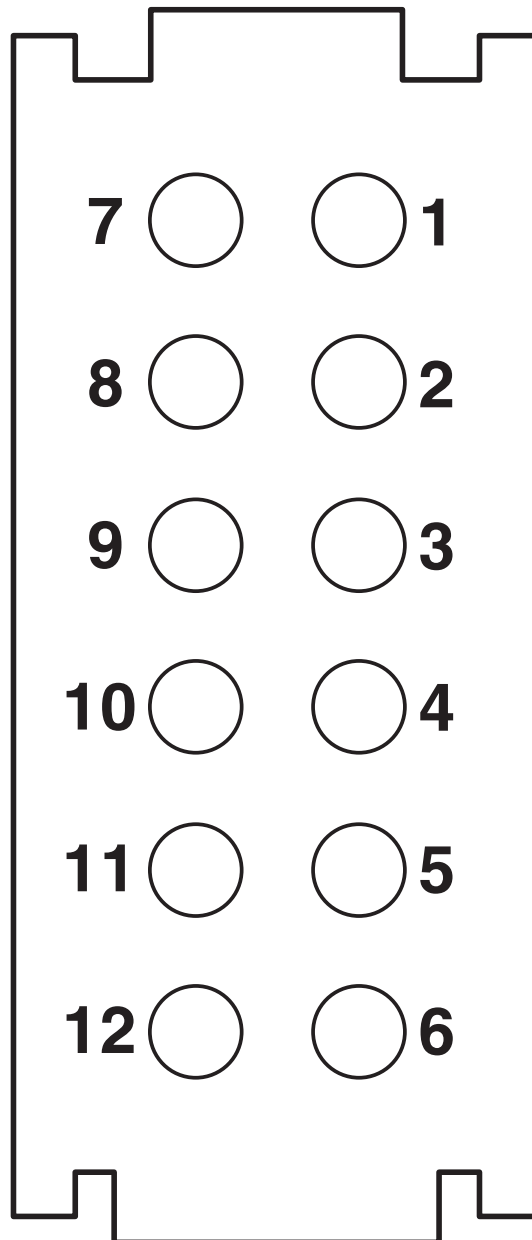

Connector pin assignment, connection side

Contact insert module - HC-M-12-PT-F

1424228

<https://www.phoenixcontact.com/pc/products/1424228>

Diagram

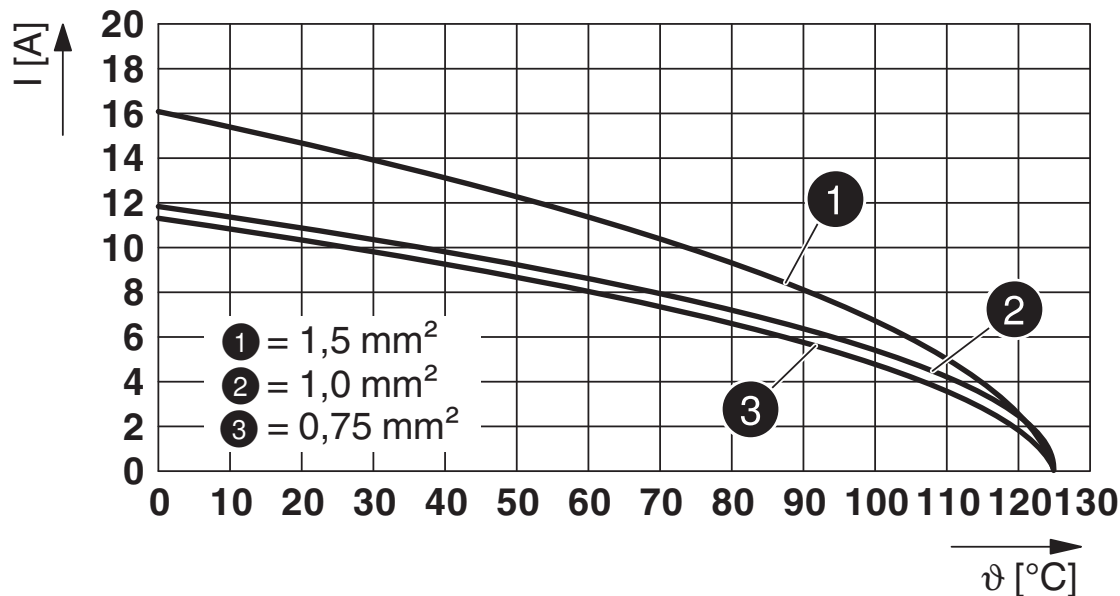

Derating diagram

Dimensional drawing

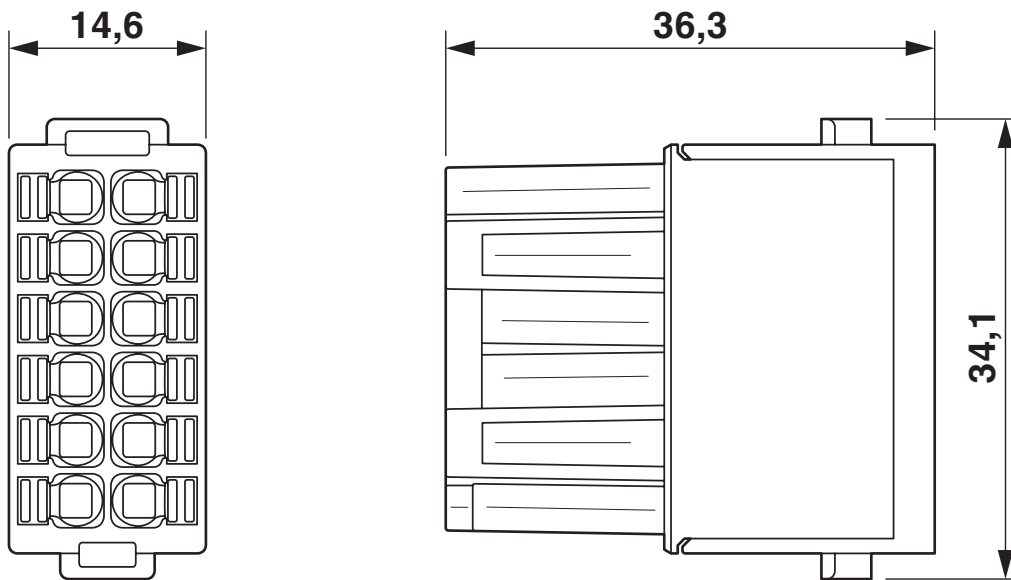

Dimensional drawing

Contact insert module - HC-M-12-PT-F





1424228

<https://www.phoenixcontact.com/pc/products/1424228>

Approvals

	UL Recognized Approval ID: E118976				
		Nominal Voltage U_N	Nominal Current I_N	Cross Section AWG	Cross Section mm^2
		600 V	10 A	- 16	-

	EAC Approval ID: RU C-DE.AI30.B.01102				
---	---	--	--	--	--

	EAC Approval ID: RU C-DE.BL08.B.00511				
---	---	--	--	--	--

Contact insert module - HC-M-12-PT-F



1424228

<https://www.phoenixcontact.com/pc/products/1424228>

Classifications

ECLASS

ECLASS-9.0	27440217
ECLASS-10.0.1	27440217
ECLASS-11.0	27440217

ETIM

ETIM 8.0	EC000438
----------	----------

UNSPSC

UNSPSC 21.0	39121400
-------------	----------

Contact insert module - HC-M-12-PT-F



1424228

<https://www.phoenixcontact.com/pc/products/1424228>

Environmental Product Compliance

China RoHS	Environmentally friendly use period: unlimited = EFUP-e
	No hazardous substances above threshold values

Contact insert module - HC-M-12-PT-F

1424228

<https://www.phoenixcontact.com/pc/products/1424228>

Accessories

Electrical crimping tool

Electrical crimping tool - CF CRIMPHANDY 0,5 - 1212463

<https://www.phoenixcontact.com/pc/products/1212463>



Mobile handheld device, battery-powered, for processing on-tape ferrules 0.5 mm² with functional end, suitable for PVC insulated conductors (H05V-K), incl. battery, charger, CUTFOX 12 cable cutter, waste guide plate 2, service tool for error correction, and one strip of ferrules 0.5 mm², packed in a robust case.

Electrical crimping tool

Electrical crimping tool - CF CRIMPHANDY 0,75 - 1212464

<https://www.phoenixcontact.com/pc/products/1212464>



Mobile handheld device, battery-powered, for processing on-tape ferrules 0.75 mm² with functional end, suitable for PVC insulated conductors (H05V-K), incl. battery, charger, CUTFOX 12 cable cutter, waste guide plate 2, service tool for error correction, and one strip of ferrules 0.75 mm², packed in a robust case.

Contact insert module - HC-M-12-PT-F

1424228

<https://www.phoenixcontact.com/pc/products/1424228>

Electrical crimping tool

Electrical crimping tool - CF CRIMPHANDY 1,0 - 1212465

<https://www.phoenixcontact.com/pc/products/1212465>



Mobile handheld device, battery-powered, for processing on-tape ferrules 1.0 mm² with functional end, suitable for PVC insulated conductors (H05V-K), incl. battery, charger, CUTFOX 12 cable cutter, waste guide plate 2, service tool for error correction, and one strip of ferrules 1.0 mm², packed in a robust case.

Electrical crimping tool

Electrical crimping tool - CF CRIMPHANDY 1,5 - 1212466

<https://www.phoenixcontact.com/pc/products/1212466>



Mobile handheld device, battery-powered, for processing on-tape ferrules 1.5 mm² with functional end, suitable for PVC insulated conductors (H07V-K), incl. battery, charger, CUTFOX 12 cable cutter, waste guide plate 2, service tool for error correction, and one strip of ferrules 1.5 mm², packed in a robust case.

Contact insert module - HC-M-12-PT-F

1424228

<https://www.phoenixcontact.com/pc/products/1424228>

Module carrier frame

Module carrier frame - HC-M-B06-MFH-B - 1182085

<https://www.phoenixcontact.com/pc/products/1182085>

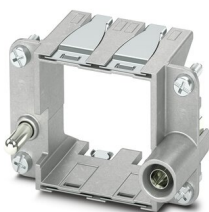

Module carrier frame, size: B6, type : for the panel mounting side (a, b, c, ...), 4 mm² ... 6 mm², application: Module carrier frame

Module carrier frame

Module carrier frame - HC-M-B10-MFH-B - 1182088

<https://www.phoenixcontact.com/pc/products/1182088>

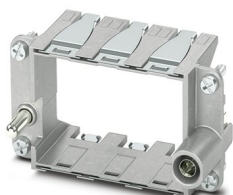

Module carrier frame, size: B10, type : for the panel mounting side (a, b, c, ...), 4 mm² ... 6 mm², application: Module carrier frame

Contact insert module - HC-M-12-PT-F

1424228

<https://www.phoenixcontact.com/pc/products/1424228>

Module carrier frame

Module carrier frame - HC-M-B16-MFH-B - 1182090

<https://www.phoenixcontact.com/pc/products/1182090>

Module carrier frame, size: B16, type : for the panel mounting side (a, b, c, ...), 4 mm² ... 6 mm², application: Module carrier frame



Module carrier frame

Module carrier frame - HC-M-B24-MFH-B - 1182094

<https://www.phoenixcontact.com/pc/products/1182094>

Module carrier frame, size: B24, type : for the panel mounting side (a, b, c, ...), 4 mm² ... 6 mm², application: Module carrier frame



Contact insert module - HC-M-12-PT-F

1424228

<https://www.phoenixcontact.com/pc/products/1424228>

Module carrier frame

Module carrier frame - HC-M-B06-MFH-H - 1182087

<https://www.phoenixcontact.com/pc/products/1182087>



Module carrier frame, size: B6, type : for the sleeve side (A, B, C, ...), 4 mm² ... 6 mm², application: Module carrier frame

Module carrier frame

Module carrier frame - HC-M-B10-MFH-H - 1182089

<https://www.phoenixcontact.com/pc/products/1182089>



Module carrier frame, size: B10, type : for the sleeve side (A, B, C, ...), 4 mm² ... 6 mm², application: Module carrier frame

Contact insert module - HC-M-12-PT-F

1424228

<https://www.phoenixcontact.com/pc/products/1424228>

Module carrier frame

Module carrier frame - HC-M-B16-MFH-H - 1182093

<https://www.phoenixcontact.com/pc/products/1182093>

Module carrier frame, size: B16, type : for the sleeve side (A, B, C, ...), 4 mm² ...
6 mm², application: Module carrier frame



Module carrier frame

Module carrier frame - HC-M-B24-MFH-H - 1182095

<https://www.phoenixcontact.com/pc/products/1182095>

Module carrier frame, size: B24, type : for the sleeve side (A, B, C, ...), 4 mm² ...
6 mm², application: Module carrier frame



Contact insert module - HC-M-12-PT-F

1424228

<https://www.phoenixcontact.com/pc/products/1424228>

Coding element

Coding element - HC-CBU-MOD - 1636130

<https://www.phoenixcontact.com/pc/products/1636130>



Coding socket for coding up to 16 connectors, for HC Modular

Coding element

Coding element - HC-CST-MOD - 1636127

<https://www.phoenixcontact.com/pc/products/1636127>



Coding peg for coding up to 16 connectors, for HC Modular

Contact insert module - HC-M-12-PT-F

1424228

<https://www.phoenixcontact.com/pc/products/1424228>

Crimping pliers

Crimping pliers - CRIMPFOX CENTRUS 6S - 1213144

<https://www.phoenixcontact.com/pc/products/1213144>



Crimping pliers, for uninsulated and insulated ferrules, DIN 46228 Part 1 and 4, from 0.14 mm² ... 6 mm², also for TWIN ferrules up to 2 x 4 mm², automatic cross section adjustment, lateral insertion, equipped with fall protection

Crimping pliers

Crimping pliers - CRIMPFOX CENTRUS 10S - 1213154

<https://www.phoenixcontact.com/pc/products/1213154>



Crimping pliers, for uninsulated and insulated ferrules, DIN 46228 Part 1 and 4, from 0.14 mm² ... 10 mm², also for TWIN ferrules up to 2 x 4 mm², automatic cross section adjustment, lateral insertion, equipped with fall protection

Contact insert module - HC-M-12-PT-F

1424228

<https://www.phoenixcontact.com/pc/products/1424228>

Crimping pliers

Crimping pliers - CRIMPFOX 6 - 1212034

<https://www.phoenixcontact.com/pc/products/1212034>



Crimping pliers, for ferrules without insulating collar according to DIN 46228 Part 1 and ferrules with insulating collar according to DIN 46228 Part 4, 0.25 mm² ... 6.0 mm², lateral entry, trapezoidal crimp

Crimping pliers

Crimping pliers - CRIMPFOX 10S - 1212045

<https://www.phoenixcontact.com/pc/products/1212045>



Crimping pliers, for ferrules without insulating collar according to DIN 46228 Part 1 and ferrules with insulating collar according to DIN 46228 Part 4, 0.14 mm² ... 10 mm², unlockable pressure lock, lateral entry

Contact insert module - HC-M-12-PT-F



1424228

<https://www.phoenixcontact.com/pc/products/1424228>

Contact insert module

Contact insert module - HC-M-12-PT-M - 1424246

<https://www.phoenixcontact.com/pc/products/1424246>



Contact insert module, number of positions: 12, power contacts: 0, control contacts: 12, Pin, Push-in connection, 250 V, 10 A, 0.14 mm² ... 1.5 mm², application: Signal

Phoenix Contact 2022 © - all rights reserved

<https://www.phoenixcontact.com>

PHOENIX CONTACT GmbH & Co. KG

Flachsmarktstraße 8

D-32825 Blomberg

+49 (0) 5235-3 00

info@phoenixcontact.com