

PCB connector - FK-MC 0,5/12-ST-2,5

1881422

<https://www.phoenixcontact.com/de/produkte/1881422>

Please be informed that the data shown in this PDF document is generated from our Online Catalog. Please find the complete data in the user documentation. Our General Terms of Use for Downloads are valid.

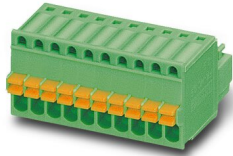

PCB connector, nominal cross section: 0.5 mm², color: green, nominal current: 4 A, rated voltage (III/2): 160 V, contact surface: Tin, type of contact: Female connector, number of potentials: 12, number of rows: 1, number of positions: 12, number of connections: 12, product range: FK-MC 0,5/..-ST, pitch: 2.5 mm, connection method: Push-in spring connection, conductor/PCB connection direction: 0 °, number of solder pins per potential: 1, plug-in system: COMBICON FK-MC 0,5, locking: without, mounting: without, type of packaging: packed in cardboard

Your advantages

- Time saving push-in connection, tools not required
- Defined contact force ensures that contact remains stable over the long term
- Intuitive use through colour coded actuation lever
- Operation and conductor connection from one direction enable integration into front of device
- Quick and convenient testing using integrated test option

PCB connector - FK-MC 0,5/12-ST-2,5



1881422

<https://www.phoenixcontact.com/de/produkte/1881422>

Commercial Data

Item number	1881422
Packing unit	50 pc
Minimum order quantity	50 pc
Sales Key	E1 - Leiterplattenanschl.
Product Key	AAAFCA
Catalog Page	Page 168 (C-1-2013)
GTIN	4017918156671
Weight per Piece (including packing)	7,42 g
Weight per Piece (excluding packing)	6,895 g
Customs tariff number	85366990
Country of origin	DE

PCB connector - FK-MC 0,5/12-ST-2,5



1881422

<https://www.phoenixcontact.com/de/produkte/1881422>

Technical Data

Product properties

Type	Standard
Product line	COMBICON Connectors XS
Product type	PCB plug
Number of positions	12
Pitch	2.5 mm
Number of connections	12
Number of rows	1
Mounting flange	without
Number of potentials	12

Electrical properties

Nominal current I_N	4 A
Nominal voltage U_N	160 V
Pollution degree	3
Contact resistance	2 m Ω
Rated voltage (III/3)	100 V
Rated surge voltage (III/3)	1.5 kV
Rated voltage (III/2)	160 V
Rated surge voltage (III/2)	2.5 kV

Connection data

Connection technology

Type	Standard
Connector system	COMBICON FK-MC 0,5
Nominal cross section	0.5 mm ²
Type of contact	Female connector

Interlock

Locking type	without
Mounting flange	without

Conductor connection

Connection method	Push-in spring connection
Conductor/PCB connection direction	0 °
Conductor cross section solid	0.14 mm ² ... 0.5 mm ²
Conductor cross section flexible	0.14 mm ² ... 0.5 mm ²
Conductor cross section AWG	26 ... 20
Conductor cross section flexible, with ferrule without plastic sleeve	0.25 mm ² ... 0.5 mm ²
Cylindrical gauge a x b / diameter	- / 1.4 mm
Stripping length	8 mm

PCB connector - FK-MC 0,5/12-ST-2,5

1881422

<https://www.phoenixcontact.com/de/produkte/1881422>

Material specifications

Material data - contact

Note	WEEE/RoHS-compliant, free of whiskers according to IEC 60068-2-82/JEDEC JESD 201
Contact material	Cu alloy
Surface characteristics	hot-dip tin-plated
Metal surface terminal point (top layer)	Tin (4 - 8 µm Sn)
Metal surface contact area (top layer)	Tin (4 - 8 µm Sn)

Material data - housing

Housing color	green (6021)
Insulating material	PA
Insulating material group	I
CTI according to IEC 60112	600
Flammability rating according to UL 94	V0
Glow wire flammability index GWFI according to EN 60695-2-12	850
Glow wire ignition temperature GWIT according to EN 60695-2-13	775
Temperature for the ball pressure test according to EN 60695-10-2	125 °C

Material data – actuating element

Insulating material	PBT
Insulating material group	I
CTI according to IEC 60112	600
Flammability rating according to UL 94	V0

Dimensions

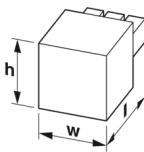
Dimensional drawing	
Pitch	2.5 mm
Width [w]	30.6 mm
Height [h]	11.75 mm
Length [l]	19.05 mm
Installed height	11.75 mm

Notes

Notes on operation	In accordance with IEC 61984, COMBICON connectors have no switching power (COC). During designated use, they must not be plugged in or disconnected when carrying voltage or under load.
--------------------	--

Mechanical tests

PCB connector - FK-MC 0,5/12-ST-2,5



1881422

<https://www.phoenixcontact.com/de/produkte/1881422>

Test for conductor damage and slackening

Specification	IEC 60999-1:1999-11
Result	Test passed

Repeated connection and disconnection

Specification	IEC 60999-1:1999-11
Result	Test passed

Pull-out test

Specification	IEC 60999-1:1999-11
Conductor cross section/conductor type/tractive force setpoint/actual value	0.2 mm ² / solid / > 10 N
	0.2 mm ² / flexible / > 10 N
	0.5 mm ² / solid / > 20 N
	0.5 mm ² / flexible / > 20 N

Insertion and withdrawal forces

Result	Test passed
No. of cycles	25
Insertion strength per pos. approx.	8 N
Withdraw strength per pos. approx.	6 N

Contact holder in insert

Specification	IEC 60512-15-1:2008-05
Contact holder in insert Requirements >20 N	Test passed

Resistance of inscriptions

Specification	IEC 60068-2-70:1995-12
Result	Test passed

Polarization and coding

Specification	IEC 60512-13-5:2006-02
Result	Test passed

Visual inspection

Specification	IEC 60512-1-1:2002-02
Result	Test passed

Dimension check

Specification	IEC 60512-1-2:2002-02
Result	Test passed

Environmental and real-life conditions

Vibration test

Specification	IEC 60068-2-6:2007-12
Frequency	10 - 150 - 10 Hz
Sweep speed	1 octave/min

PCB connector - FK-MC 0,5/12-ST-2,5



1881422

<https://www.phoenixcontact.com/de/produkte/1881422>

Amplitude	0.35 mm (10 - 60.1 Hz)
Sweep speed	5g (60.1 - 150 Hz)
Test duration per axis	2.5 h

Durability test

Specification	IEC 60512-9-1:2010-03
Impulse withstand voltage at sea level	2.95 kV
Contact resistance R ₁	2 mΩ
Contact resistance R ₂	2.2 mΩ
Insertion/withdrawal cycles	25
Insulation resistance, neighboring positions	> 5 MΩ

Climatic test

Specification	ISO 6988:1985-02
Corrosive stress	0.2 dm ³ SO ₂ on 300 dm ³ /40 °C/1 cycle
Thermal stress	100 °C/168 h
Power-frequency withstand voltage	1.39 kV

Ambient conditions

Ambient temperature (operation)	-40 °C ... 100 °C (dependent on the derating curve)
Ambient temperature (storage/transport)	-40 °C ... 70 °C
Relative humidity (storage/transport)	30 % ... 70 %
Ambient temperature (assembly)	-5 °C ... 100 °C

Electrical tests

Thermal test | Test group C

Specification	IEC 60512-5-1:2002-02
Tested number of positions	12

Insulation resistance

Specification	IEC 60512-3-1:2002-02
Insulation resistance, neighboring positions	> 5 MΩ

Temperature cycles

Specification	IEC 60999-1:1999-11
Result	Test passed

Air clearances and creepage distances |

Specification	IEC 60664-1:1992-10 + A1:2000-02 + A2:2002-05
Insulating material group	I
Comparative tracking index (IEC 60112)	CTI 600
Rated insulation voltage (III/3)	100 V
Rated surge voltage (III/3)	1.5 kV
minimum clearance value - non-homogenous field (III/3)	0.8 mm
minimum creepage distance (III/3)	1.8 mm
Rated insulation voltage (III/2)	160 V

PCB connector - FK-MC 0,5/12-ST-2,5



1881422

<https://www.phoenixcontact.com/de/produkte/1881422>

Rated surge voltage (III/2)	2.5 kV
minimum clearance value - non-homogenous field (III/2)	1.5 mm
minimum creepage distance (III/2)	1.5 mm
Rated insulation voltage (II/2)	320 V
Rated surge voltage (II/2)	2.5 kV
minimum clearance value - non-homogenous field (II/2)	1.5 mm
minimum creepage distance (II/2)	1.6 mm

Packaging specifications

Type of packaging	packed in cardboard
-------------------	---------------------

Drawings

Diagram

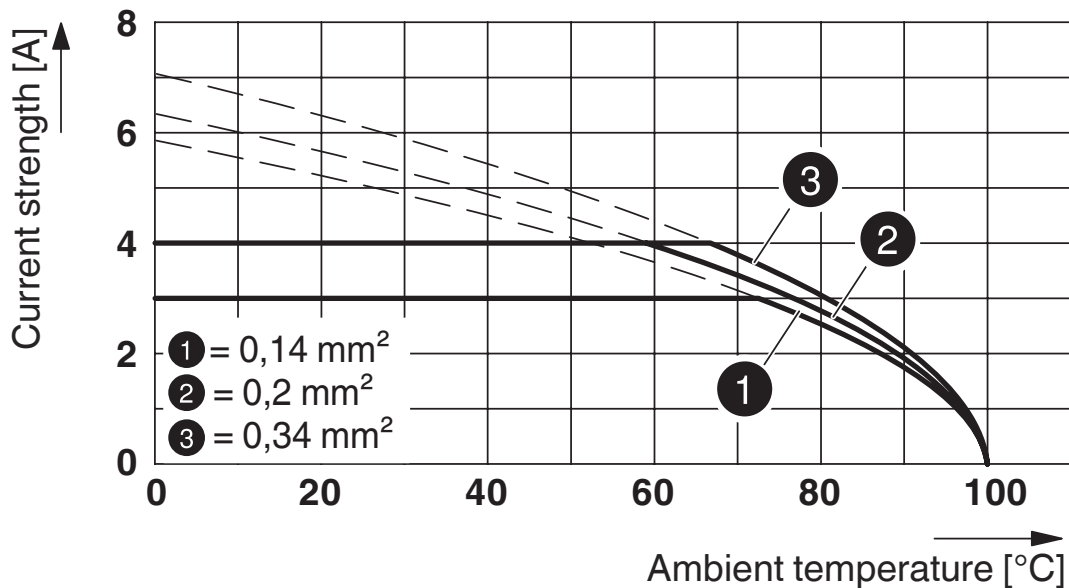

Type: FK-MC 0,5/...-ST-2,5 with MC 0,5/...-G-2,5

Diagram

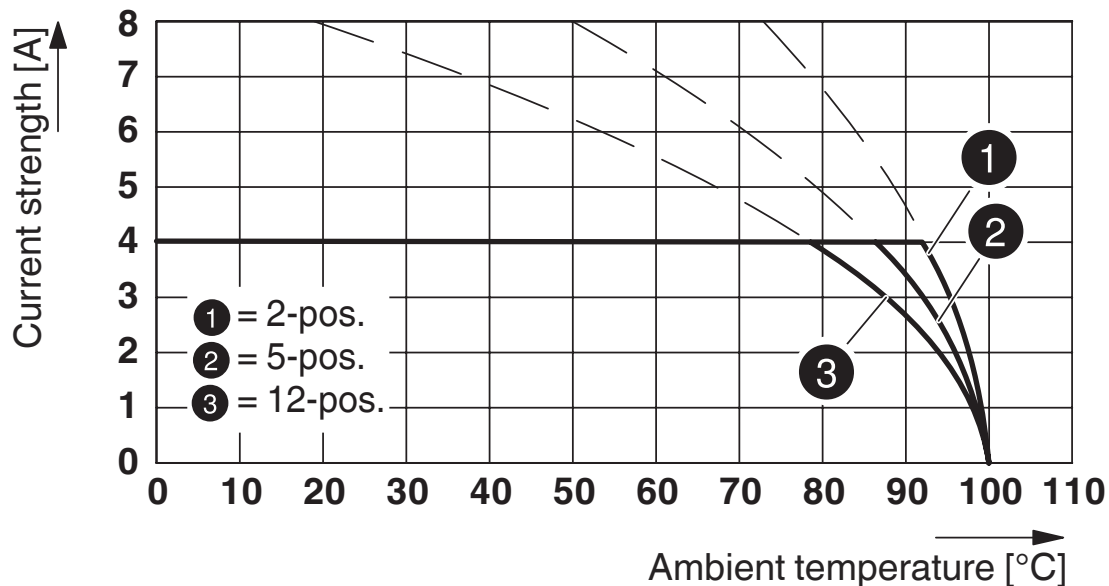

Type: FK-MC 0,5/...-ST-2,5 with MCV 0,5/...-G-2,5

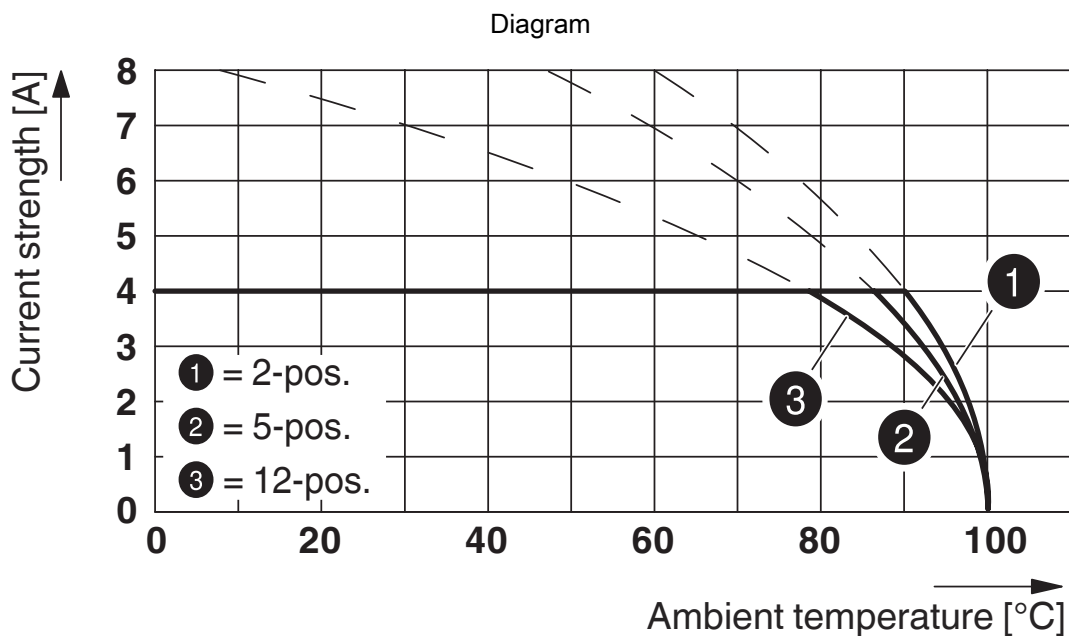

Type: FK-MC 0,5/...-ST-2,5 with MC 0,5/...-G-2,5 THT

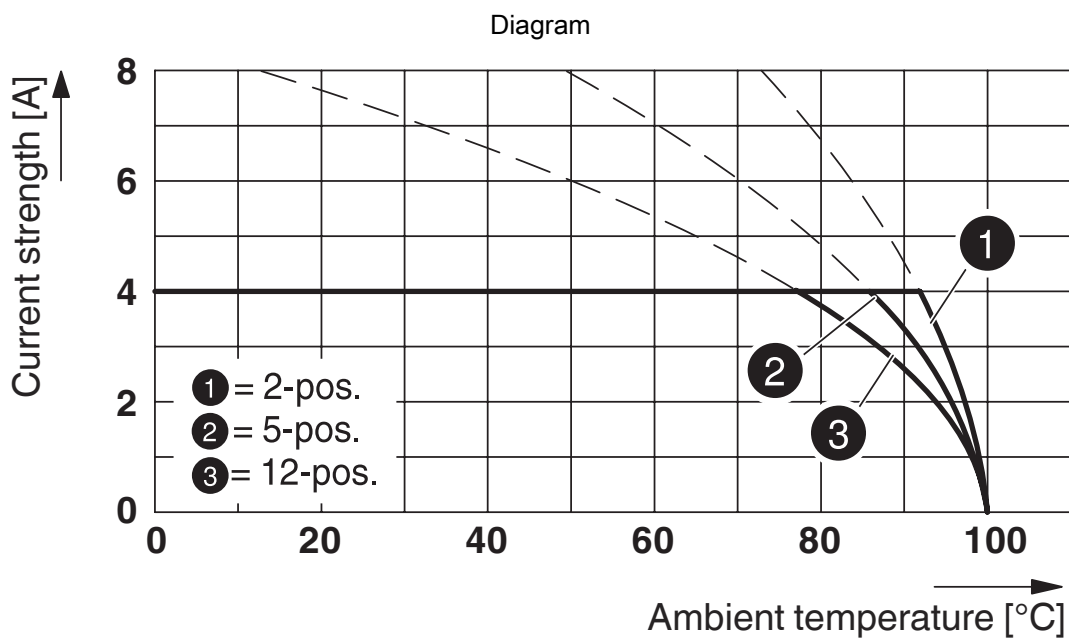

Type: FK-MC 0,5/...-ST-2,5 with MC 0,5/...-G-2,5

PCB connector - FK-MC 0,5/12-ST-2,5

1881422

<https://www.phoenixcontact.com/de/produkte/1881422>

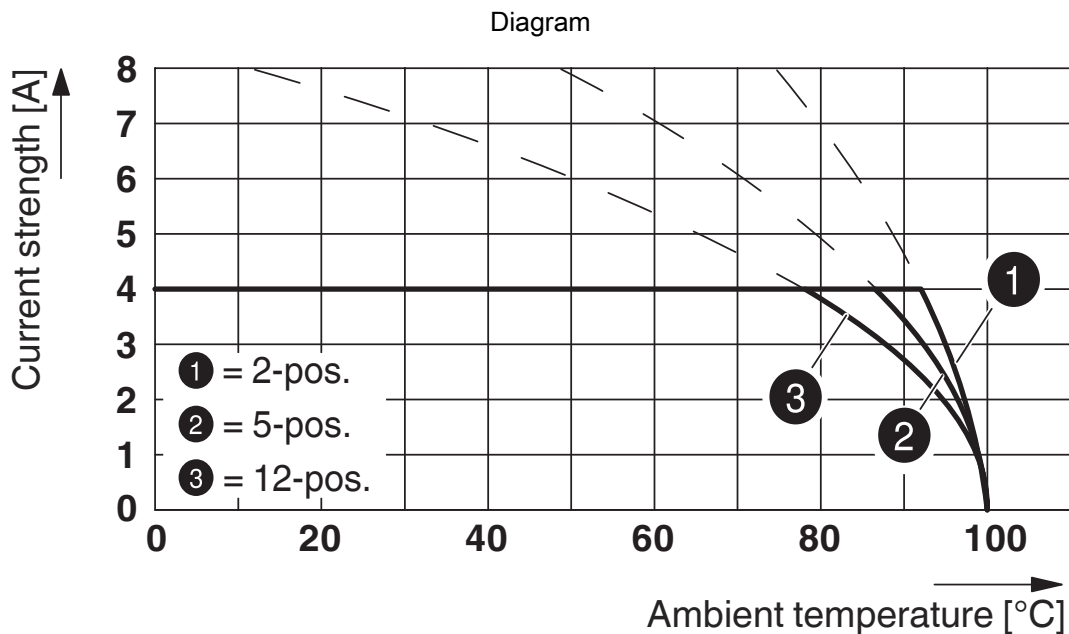

Type: FK-MC 0,5/...-ST-2,5 with MCV 0,5/...-G-2,5 THT

Dimensional drawing

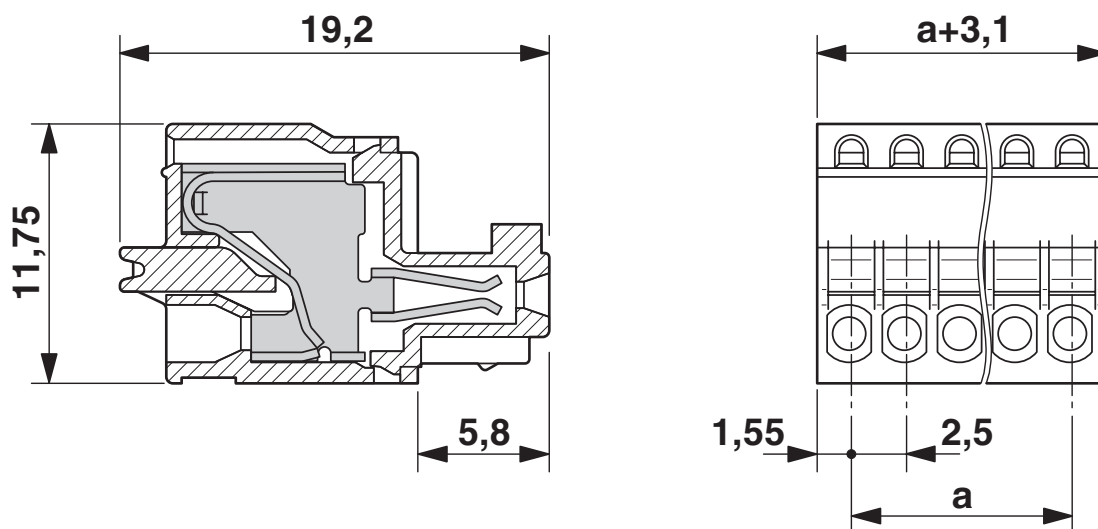

1881422

<https://www.phoenixcontact.com/de/produkte/1881422>

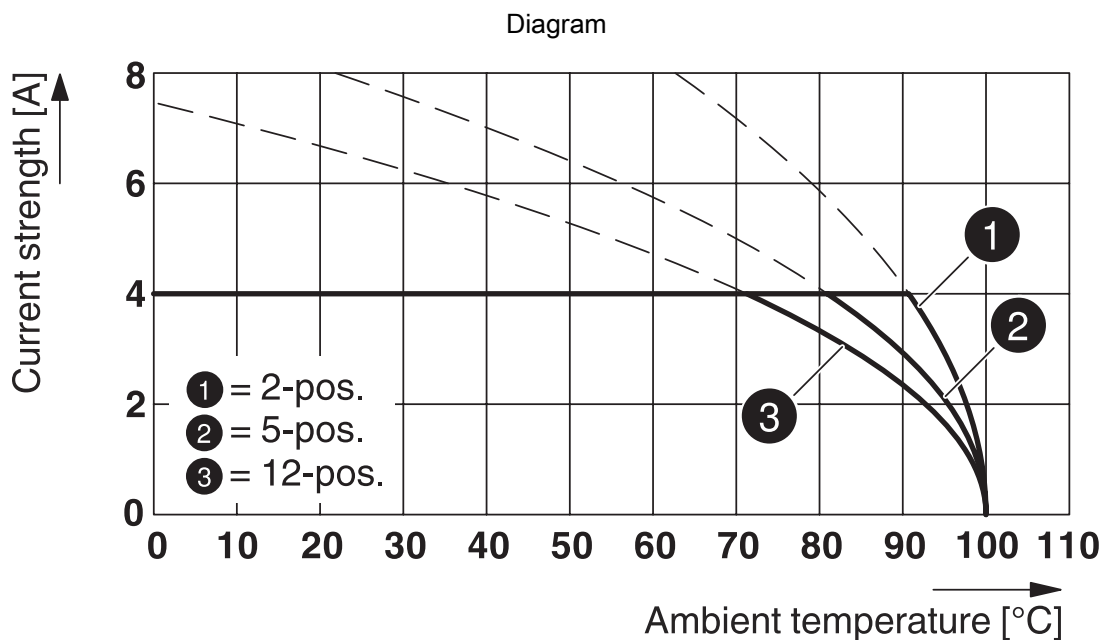

Type: FK-MC 0,5/...-ST-2,5 with MCD 0,5/...-G1-2,5 HT BK

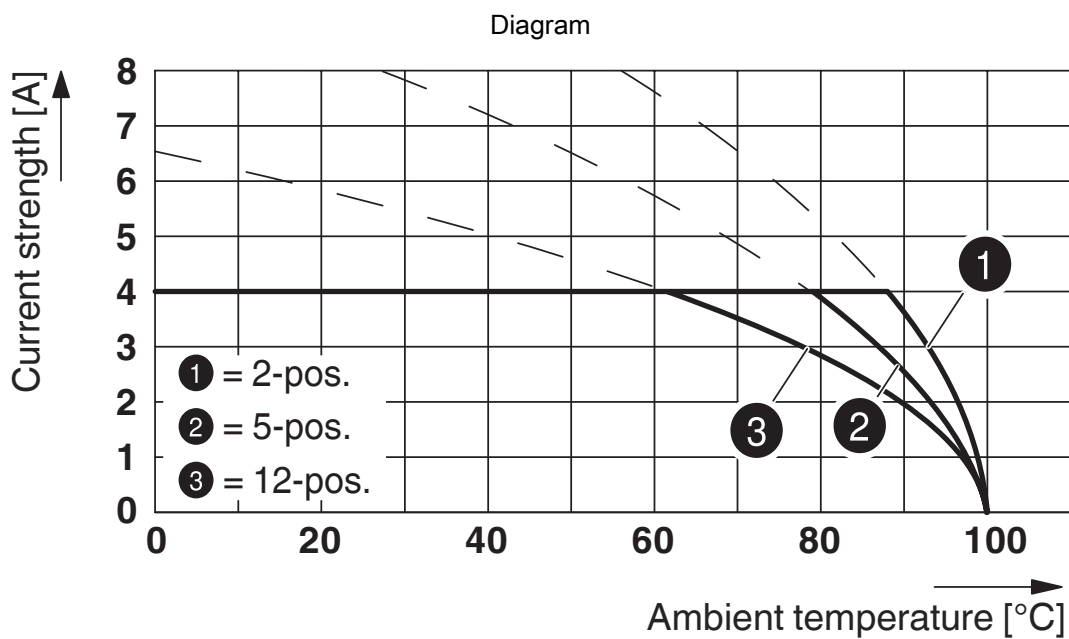

Type: FK-MC 0,5/...-ST-2,5 with MCD 0,5/...-G1-2,5

PCB connector - FK-MC 0,5/12-ST-2,5





1881422

<https://www.phoenixcontact.com/de/produkte/1881422>

Approvals

 IECEE CB Scheme Approval ID: DE1-56068-B1B2				
	Nominal Voltage U_N	Nominal Current I_N	Cross Section AWG	Cross Section mm^2
	100 V	4 A	-	0.2 - 0.5

 EAC Approval ID: B.01687				
--	--	--	--	--

 cULus Recognized Approval ID: E60425-19930913				
	Nominal Voltage U_N	Nominal Current I_N	Cross Section AWG	Cross Section mm^2
Use group B	125 V	4 A	28 - 20	-

CCA Approval ID: CCA/ DE1 34250				
	Nominal Voltage U_N	Nominal Current I_N	Cross Section AWG	Cross Section mm^2
	100 V	4 A	-	0.2 - 0.5

 VDE report with production monitoring Approval ID: 40013394				
	Nominal Voltage U_N	Nominal Current I_N	Cross Section AWG	Cross Section mm^2
	100 V	4 A	-	0.2 - 0.5

PCB connector - FK-MC 0,5/12-ST-2,5



1881422

<https://www.phoenixcontact.com/de/produkte/1881422>

Classifications

ECLASS

ECLASS-9.0	27440309
ECLASS-10.0.1	27440309
ECLASS-11.0	27460202

ETIM

ETIM 8.0	EC002638
----------	----------

UNSPSC

UNSPSC 21.0	39121400
-------------	----------

PCB connector - FK-MC 0,5/12-ST-2,5



1881422

<https://www.phoenixcontact.com/de/produkte/1881422>

Environmental Product Compliance

China RoHS	Environmentally friendly use period: unlimited = EFUP-e
	No hazardous substances above threshold values

PCB connector - FK-MC 0,5/12-ST-2,5

1881422

<https://www.phoenixcontact.com/de/produkte/1881422>

Accessories

Screwdriver

Screwdriver - SZS 0,4X2,0 - 1205202

<https://www.phoenixcontact.com/de/produkte/1205202>



Micro screwdriver, bladed, size: 0.4 x 2.0 x 60 mm, 2-component grip, with non-slip grip and twist cap

Marker card

Marker card - SK 2,54/2,8:FORTL.ZAHLEN - 0804853

<https://www.phoenixcontact.com/de/produkte/0804853>

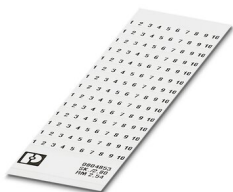

Marker card, white, labeled, horizontal: consecutive numbers 1 ... 10, 11 ... 20, etc. up to 91 ... 99, mounting type: adhesive, for terminal block width: 2.54 mm, lettering field size: 2.54 x 2.8 mm

PCB connector - FK-MC 0,5/12-ST-2,5

1881422

<https://www.phoenixcontact.com/de/produkte/1881422>

PCB header

PCB header - MC 0,5/12-G-2,5 - 1881545

<https://www.phoenixcontact.com/de/produkte/1881545>

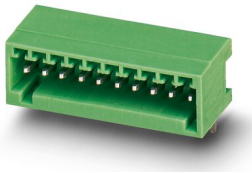

PCB headers, nominal cross section: 0.5 mm², color: green, nominal current: 4 A, rated voltage (III/2): 160 V, contact surface: Tin, type of contact: Male connector, number of potentials: 12, number of rows: 1, number of positions: 12, number of connections: 12, product range: MC 0,5/...-G, pitch: 2.5 mm, conductor/PCB connection direction: 0 °, pin layout: Linear pinning, solder pin [P]: 3.8 mm, number of solder pins per potential: 1, plug-in system: COMBICON FK-MC 0,5, Pin connector pattern alignment: Standard, locking: without, mounting: without, type of packaging: packed in cardboard

PCB header

PCB header - MCV 0,5/12-G-2,5 - 1881655

<https://www.phoenixcontact.com/de/produkte/1881655>

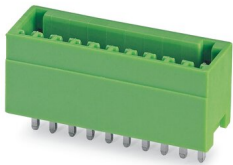

PCB headers, nominal cross section: 0.5 mm², color: green, nominal current: 4 A, rated voltage (III/2): 160 V, contact surface: Tin, type of contact: Male connector, number of potentials: 12, number of rows: 1, number of positions: 12, number of connections: 12, product range: MCV 0,5/...-G, pitch: 2.5 mm, pin layout: Linear pinning, solder pin [P]: 3.5 mm, number of solder pins per potential: 1, plug-in system: COMBICON FK-MC 0,5, Pin connector pattern alignment: Standard, locking: without, mounting: without, type of packaging: packed in cardboard

PCB connector - FK-MC 0,5/12-ST-2,5

1881422

<https://www.phoenixcontact.com/de/produkte/1881422>

PCB header

PCB header - MCD 0,5/12-G1-2,5 - 1894901

<https://www.phoenixcontact.com/de/produkte/1894901>



PCB headers, nominal cross section: 0.5 mm², color: green, nominal current: 4 A, rated voltage (III/2): 160 V, contact surface: Tin, type of contact: Male connector, number of potentials: 24, number of rows: 2, number of positions: 12, number of connections: 24, product range: MCD 0,5/...-G1, pitch: 2.5 mm, pin layout: Linear pinning, solder pin [P]: 3.8 mm, number of solder pins per potential: 1, plug-in system: COMBICON FK-MC 0,5, Pin connector pattern alignment: Standard, locking: without, mounting: without, type of packaging: packed in cardboard

PCB header

PCB header - MC 0,5/12-G-2,5 THT - 1939316

<https://www.phoenixcontact.com/de/produkte/1939316>

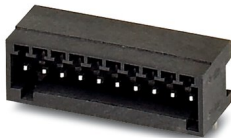

PCB headers, nominal cross section: 0.5 mm², color: black, nominal current: 4 A, rated voltage (III/2): 160 V, contact surface: Tin, type of contact: Male connector, number of potentials: 12, number of rows: 1, number of positions: 12, number of connections: 12, product range: MC 0,5/...-G-THT, pitch: 2.5 mm, pin layout: Linear pinning, solder pin [P]: 3.8 mm, number of solder pins per potential: 1, plug-in system: COMBICON FK-MC 0,5, Pin connector pattern alignment: Standard, locking: without, mounting: without, type of packaging: packed in cardboard, For user information and design recommendations for through-hole reflow technology, go to: Downloads

PCB connector - FK-MC 0,5/12-ST-2,5

1881422

<https://www.phoenixcontact.com/de/produkte/1881422>

PCB header

PCB header - MCD 0,5/12-G1-2,5 HT BK - 1955141

<https://www.phoenixcontact.com/de/produkte/1955141>



PCB headers, nominal cross section: 0.5 mm^2 , color: black, nominal current: 4 A, rated voltage (III/2): 160 V, contact surface: Tin, type of contact: Male connector, number of potentials: 24, number of rows: 2, number of positions: 12, number of connections: 24, product range: MCD 0,5/...-G1-HT, pitch: 2.5 mm, pin layout: Linear pinning, solder pin [P]: 3.8 mm, number of solder pins per potential: 1, plug-in system: COMBICON FK-MC 0,5, Pin connector pattern alignment: Standard, locking: without, mounting: without, type of packaging: packed in cardboard, Standard component made of highly temperature resistant plastic; suitable for reflow process. User information and design recommendations on Through Hole Reflow Technology can be found at: "Downloads".

PCB header

PCB header - MC 0,5/12-G-2,5 THT R44 - 1963748

<https://www.phoenixcontact.com/de/produkte/1963748>

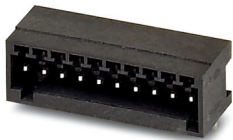

PCB headers, nominal cross section: 0.5 mm^2 , color: black, nominal current: 4 A, rated voltage (III/2): 160 V, contact surface: Tin, type of contact: Male connector, number of potentials: 12, number of rows: 1, number of positions: 12, number of connections: 12, product range: MC 0,5/...-G-THT, pitch: 2.5 mm, pin layout: Linear pinning, solder pin [P]: 3.8 mm, number of solder pins per potential: 1, plug-in system: COMBICON FK-MC 0,5, Pin connector pattern alignment: Standard, locking: without, mounting: without, type of packaging: 44 mm wide tape, For user information and design recommendations for through-hole reflow technology, go to: Downloads

PCB connector - FK-MC 0,5/12-ST-2,5



1881422

<https://www.phoenixcontact.com/de/produkte/1881422>

PCB header

PCB header - MCV 0,5/12-G-2,5 THT R44 - 1963861

<https://www.phoenixcontact.com/de/produkte/1963861>

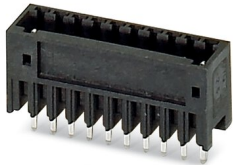

PCB headers, nominal cross section: 0.5 mm², color: black, nominal current: 4 A, rated voltage (III/2): 160 V, contact surface: Tin, type of contact: Male connector, number of potentials: 12, number of rows: 1, number of positions: 12, number of connections: 12, product range: MCV 0,5/...-G-THT, pitch: 2.5 mm, pin layout: Linear pinning, solder pin [P]: 3.5 mm, number of solder pins per potential: 1, plug-in system: COMBICON FK-MC 0,5, Pin connector pattern alignment: Standard, locking: without, mounting: without, type of packaging: 44 mm wide tape, User information and design recommendations on Through Hole Reflow Technology can be found at: "Downloads"

Phoenix Contact 2022 © - all rights reserved

<https://www.phoenixcontact.com>

PHOENIX CONTACT Deutschland GmbH

Flachsmarktstraße 8

D-32825 Blomberg

+49 52 35/3-1 20 00

info@phoenixcontact.de