

Relay Module - PLC-RSC-120UC/21

2966197

<https://www.phoenixcontact.com/de/produkte/2966197>

Please be informed that the data shown in this PDF document is generated from our Online Catalog. Please find the complete data in the user documentation. Our General Terms of Use for Downloads are valid.



PLC-INTERFACE, consisting of basic terminal block PLC-BSC.../21 with screw connection and plug-in miniature relay with power contact, for assembly on DIN rail NS 35/7,5, 1 changeover contact, input voltage 120 V AC/110 V DC

Your advantages

- Slim design
- Efficient connection to system cabling using V8 adapter
- Safe isolation according to DIN EN 50178 between coil and contact
- RT III sealed relay
- Integrated input circuit and interference suppression circuit
- Functional plug-in bridges

Relay Module - PLC-RSC-120UC/21



2966197

<https://www.phoenixcontact.com/de/produkte/2966197>

Commercial Data

Item number	2966197
Packing unit	10 pc
Minimum order quantity	1 pc
Sales Key	G1 - Relais
Product Key	CK621A
Catalog Page	Page 364 (C-5-2019)
GTIN	4017918130718
Weight per Piece (including packing)	39,88 g
Weight per Piece (excluding packing)	33,16 g
Customs tariff number	85364900
Country of origin	DE

Relay Module - PLC-RSC-120UC/21

2966197

<https://www.phoenixcontact.com/de/produkte/2966197>

Set consists of

Relay base

Relay base - PLC-BSC-120UC/21 - 2966032

<https://www.phoenixcontact.com/de/produkte/2966032>



6.2 mm PLC basic terminal block with screw connection, without relay or solid-state relay, for mounting on DIN rail NS 35/7,5, 1 changeover contact, input voltage 120 V AC/DC

Single relay

Single relay - REL-MR- 60DC/21 - 2961118

<https://www.phoenixcontact.com/de/produkte/2961118>

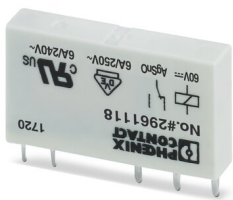

Plug-in miniature power relay, with power contact, 1 changeover contact, input voltage 60 V DC

Technical Data

Notes

Notes on operation	Separating plate PLC-ATP must be installed for voltages larger than 250 V (L1, L2, L3) between identical terminal blocks in adjacent modules. Potential bridging is then carried out with FBST 8-PLC... or FBST 500....
--------------------	---

Utilization restriction

EMC note	EMC: class A product, see manufacturer's declaration in the download area
----------	---

Product properties

Product type	Relay Module
Application	Universal
Operating mode	100% operating factor
Mechanical service life	2x 10 ⁷ cycles

Insulation characteristics

Overvoltage category	III
Pollution degree	3

Electrical properties

Maximum power dissipation for nominal condition	0.42 W
Test voltage	4 kV AC (50 Hz, 1 min., winding/contact)

Input data

Coil side

Nominal input voltage U_N	120 V AC
	110 V DC
Input voltage range	93.6 V AC ... 168 V AC (20 °C)
	85.8 V DC ... 154 V DC (20 °C)
Typical input current at U_N	3.5 mA (at $U_N = 120$ V AC)
	3 mA (at $U_N = 110$ V DC)
Typical response time	6 ms
Typical release time	15 ms
Protective circuit	Bridge rectifier; Bridge rectifier
Operating voltage display	Yellow LED

Output data

Switching

Contact type	1 changeover contact
Type of switch contact	Single contact
Drive and function	monostable
Drive (polarity)	bipolar

Relay Module - PLC-RSC-120UC/21



2966197

<https://www.phoenixcontact.com/de/produkte/2966197>

Contact material	AgSnO
Maximum switching voltage	250 V AC/DC (The separating plate PLC-ATP should be installed for voltages larger than 250 V (L1, L2, L3) between identical terminal blocks in adjacent modules. Potential bridging is then carried out with FBST 8-PLC... or ...FBST 500...)
Minimum switching voltage	5 V (100 mA)
Limiting continuous current	6 A
Maximum inrush current	10 A (4 s)
Min. switching current	10 mA (12 V)
Interrupting rating (ohmic load) max.	140 W (at 24 V DC) 20 W (at 48 V DC) 18 W (at 60 V DC) 23 W (at 110 V DC) 40 W (at 220 V DC) 1500 VA (for 250 V AC)
Switching capacity	2 A (at 24 V, DC13) 0.2 A (at 110 V, DC13) 0.1 A (at 220 V, DC13) 3 A (at 24 V, AC15) 3 A (at 120 V, AC15) 3 A (at 230 V, AC15)

Connection data

Connection method	Screw connection
Stripping length	8 mm
Screw thread	M3
Conductor cross section solid	0.14 mm ² ... 2.5 mm ²
Conductor cross section flexible	0.14 mm ² ... 2.5 mm ² 0.2 mm ² ... 2.5 mm ² (Single ferrule) 2x 0.5 mm ² ... 1.5 mm ² (TWIN ferrule)
Conductor cross section AWG	26 ... 14
Torque	0.6 Nm ... 0.8 Nm

Dimensions

Width	6.2 mm
Height	80 mm
Depth	94 mm

Material specifications

Flammability rating according to UL 94	V0 (Housing)
--	--------------

Environmental and real-life conditions

Ambient conditions

Degree of protection	IP20 (Relay base)
Ambient temperature (operation)	-40 °C ... 55 °C

Relay Module - PLC-RSC-120UC/21



2966197

<https://www.phoenixcontact.com/de/produkte/2966197>

Ambient temperature (storage/transport)	-40 °C ... 85 °C
---	------------------

Approval data

Corrosive gas test

Identification	ISA-S71.04. G3 Harsh Group
	EN 60068-2-60

Standards and regulations

Standards/regulations

Standards/regulations	IEC 60664
	EN 50178

Mounting

Mounting type	DIN rail mounting
Assembly instructions	in rows with zero spacing
Mounting position	any

Drawings

Diagram

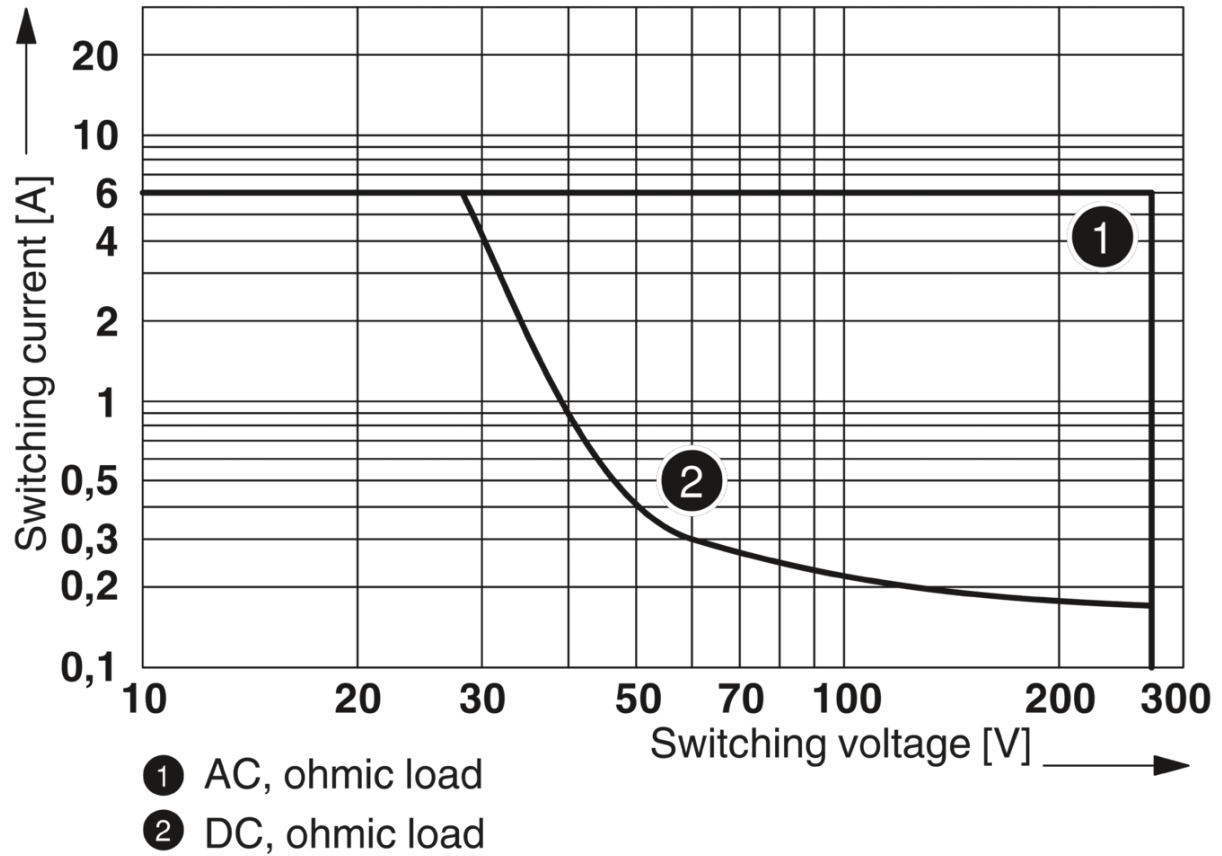

Interrupting rating

Diagram

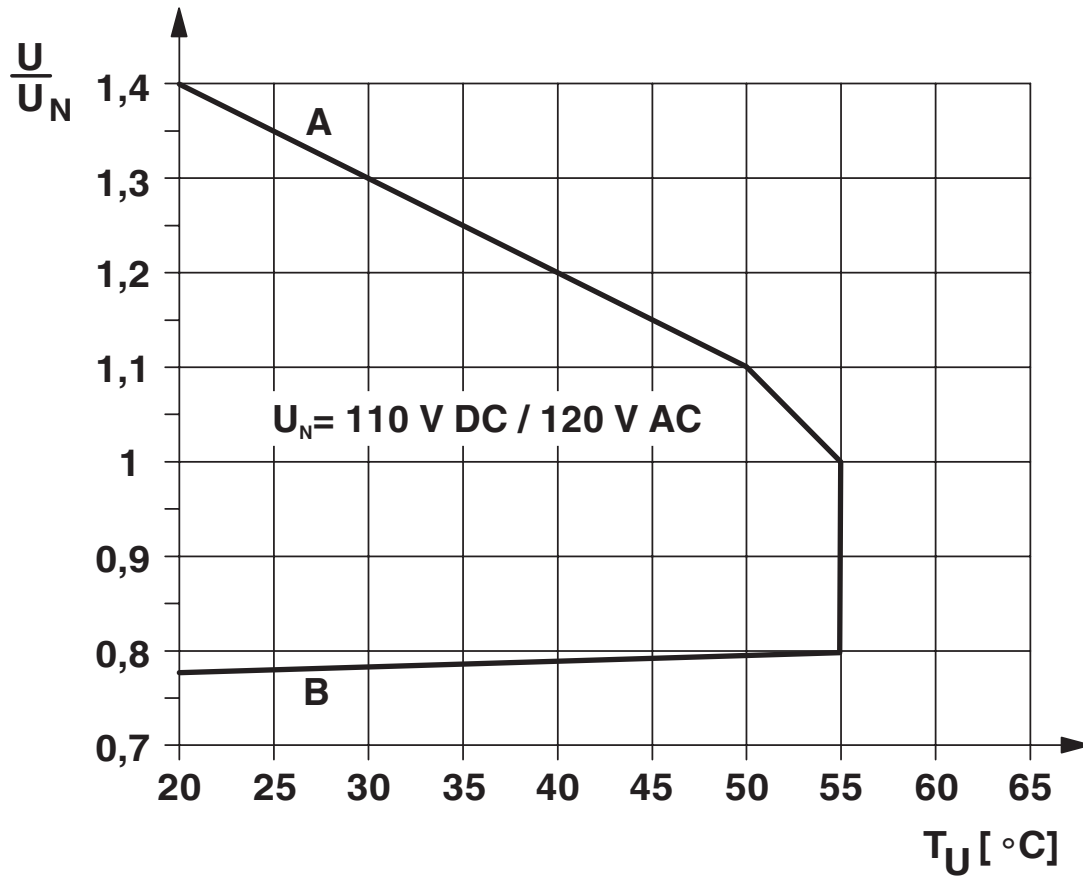

Curve A

Maximum permissible continuous voltage U_{max} with limiting continuous current on the contact side (see relevant technical data)

Curve B

Minimum permissible operate voltage U_{op} after pre-excitation (see relevant technical data)

Relay Module - PLC-RSC-120UC/21

2966197

<https://www.phoenixcontact.com/de/produkte/2966197>

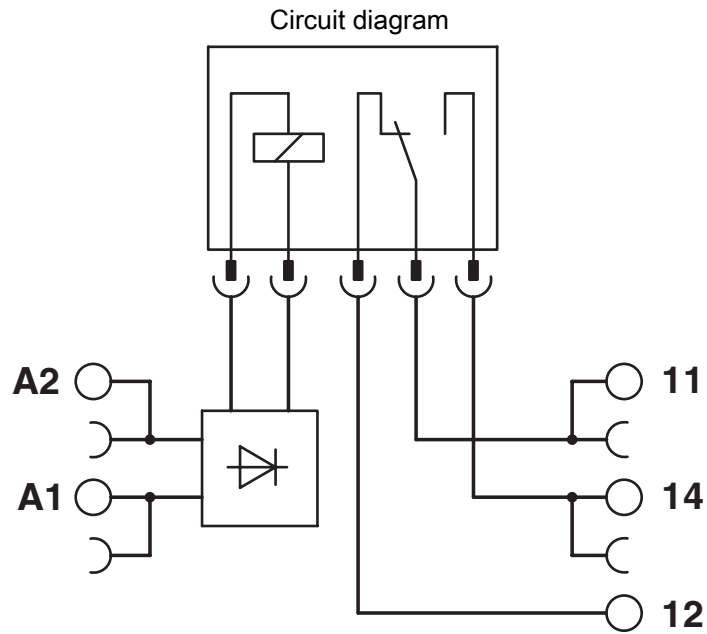

Relay Module - PLC-RSC-120UC/21



2966197

<https://www.phoenixcontact.com/de/produkte/2966197>

Approvals



cUL Recognized
Approval ID: FILE E 238705



UL Recognized
Approval ID: FILE E 238705



EAC
Approval ID: TR_TS_D_00573_c



DNV GL
Approval ID: TAE0000196

Nominal Voltage U_N

Nominal Current I_N

Cross Section AWG

Cross Section mm^2

-

-



EAC
Approval ID: RU*C-DE.*08.B.00010



PRS
Approval ID: TE/2109/880590/16



UL Listed
Approval ID: FILE E 172140



cUL Listed
Approval ID: FILE E 172140



RC FRT
Approval ID: B.00094

cULus Recognized

cULus Listed

Relay Module - PLC-RSC-120UC/21



2966197

<https://www.phoenixcontact.com/de/produkte/2966197>

Classifications

ECLASS

ECLASS-9.0	27371601
ECLASS-10.0.1	27371601
ECLASS-11.0	27371601

ETIM

ETIM 8.0	EC001437
----------	----------

UNSPSC

UNSPSC 21.0	39122300
-------------	----------

Relay Module - PLC-RSC-120UC/21



2966197

<https://www.phoenixcontact.com/de/produkte/2966197>

Environmental Product Compliance

REACH SVHC	Lead 7439-92-1
	Hexahydromethylphthalic anhydride
China RoHS	Environmentally Friendly Use Period = 50 years
	For information on hazardous substances, refer to the manufacturer's declaration available under "Downloads"

Relay Module - PLC-RSC-120UC/21

2966197

<https://www.phoenixcontact.com/de/produkte/2966197>

Accessories

 Note: Applying some accessories below might limit this product.

Continuous plug-in bridge

Continuous plug-in bridge - FBST 500-PLC RD - 2966786

<https://www.phoenixcontact.com/de/produkte/2966786>



Continuous plug-in bridge, color: red

 Max. current carrying capacity: 32 A

Continuous plug-in bridge

Continuous plug-in bridge - FBST 500-PLC BU - 2966692

<https://www.phoenixcontact.com/de/produkte/2966692>

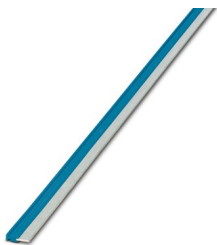

Continuous plug-in bridge, color: blue

 Max. current carrying capacity: 32 A

Relay Module - PLC-RSC-120UC/21

2966197

<https://www.phoenixcontact.com/de/produkte/2966197>



Continuous plug-in bridge

Continuous plug-in bridge - FBST 500-PLC GY - 2966838

<https://www.phoenixcontact.com/de/produkte/2966838>



Continuous plug-in bridge, color: gray

 Max. current carrying capacity: 32 A

Single plug-in bridge

Single plug-in bridge - FBST 6-PLC RD - 2966236

<https://www.phoenixcontact.com/de/produkte/2966236>

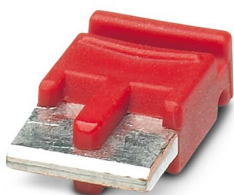

Single plug-in bridge, color: red

 Max. current carrying capacity: 6 A

Relay Module - PLC-RSC-120UC/21

2966197

<https://www.phoenixcontact.com/de/produkte/2966197>



Single plug-in bridge

Single plug-in bridge - FBST 6-PLC BU - 2966812

<https://www.phoenixcontact.com/de/produkte/2966812>

Single plug-in bridge, color: blue



 Max. current carrying capacity: 6 A

Single plug-in bridge

Single plug-in bridge - FBST 6-PLC GY - 2966825

<https://www.phoenixcontact.com/de/produkte/2966825>

Single plug-in bridge, color: gray

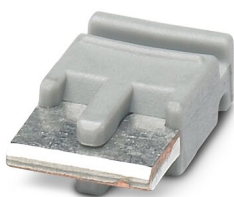

 Max. current carrying capacity: 6 A

Relay Module - PLC-RSC-120UC/21

2966197

<https://www.phoenixcontact.com/de/produkte/2966197>



Single plug-in bridge

Single plug-in bridge - FBST 8-PLC GY - 2967688

<https://www.phoenixcontact.com/de/produkte/2967688>

Single plug-in bridge, color: gray



 Max. current carrying capacity: 6 A

Power terminal block

Power terminal block - PLC-ESK GY - 2966508

<https://www.phoenixcontact.com/de/produkte/2966508>

Power terminal block, for the input of up to four potentials, for mounting on NS 35/7.5



Relay Module - PLC-RSC-120UC/21

2966197

<https://www.phoenixcontact.com/de/produkte/2966197>

Zack marker strip

Zack marker strip - ZB 6:UNBEDRUCKT - 1051003

<https://www.phoenixcontact.com/de/produkte/1051003>



Zack marker strip, Strip, white, unlabeled, can be labeled with: PLOTMARK, CMS-P1-PLOTTER, mounting type: snapped, for terminal block width: 6.2 mm, lettering field size: 6.15 x 10.5 mm, Number of individual labels: 10

Separating plate

Separating plate - PLC-ATP BK - 2966841

<https://www.phoenixcontact.com/de/produkte/2966841>



Separating plate, 2 mm thick, required at the start and end of a PLC terminal strip. Furthermore, it is used for: visual separation of groups, safe isolation of different voltages of neighboring PLC relays in acc. with DIN VDE 0106-101, isolation

Relay Module - PLC-RSC-120UC/21

2966197

<https://www.phoenixcontact.com/de/produkte/2966197>

Zack marker strip

Zack marker strip - ZB 6 CUS - 0824992

<https://www.phoenixcontact.com/de/produkte/0824992>



Zack marker strip, can be ordered: Strip, white, labeled according to customer specifications, mounting type: snap into tall marker groove, for terminal block width: 6.2 mm, lettering field size: 6.15 x 10.5 mm, Number of individual labels: 10

Screwdriver

Screwdriver - SZF 1-0,6X3,5 - 1204517

<https://www.phoenixcontact.com/de/produkte/1204517>



Actuation tool, for ST terminal blocks, also suitable for use as a bladed screwdriver, size: 0.6 x 3.5 x 100 mm, 2-component grip, with non-slip grip

Relay Module - PLC-RSC-120UC/21

2966197

<https://www.phoenixcontact.com/de/produkte/2966197>

Zack marker strip

Zack marker strip - ZB 6,LGS:FORTL.ZAHLEN - 1051016

<https://www.phoenixcontact.com/de/produkte/1051016>



Zack marker strip, Strip, white, labeled, can be labeled with: CMS-P1-PLOTTER, printed horizontally: consecutive numbers 1 ... 10, 11 ... 20, etc. up to 491 ... 500, mounting type: snapped, for terminal block width: 6.2 mm, lettering field size: 6. 15 x 10.5 mm, Number of individual labels: 10

Fuse adapter

Fuse adapter - PLC-FA-5X20 - 1186510

<https://www.phoenixcontact.com/de/produkte/1186510>



Safety plug adapter for use on a 6.2 mm PLC basic terminal block. For 5 x 20 mm fuses. Operating voltage: Universal. Without fuse failure indication.

Relay Module - PLC-RSC-120UC/21

2966197

<https://www.phoenixcontact.com/de/produkte/2966197>

Zack marker strip

Zack marker strip - ZB 6,QR:FORTL.ZAHLEN - 1051029

<https://www.phoenixcontact.com/de/produkte/1051029>

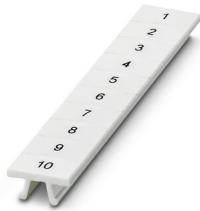

Zack marker strip, Strip, white, labeled, can be labeled with: CMS-P1-PLOTTER, Printed vertically: consecutive numbers 1 ... 10, 11 ... 20, etc. up to 491 ... 500, mounting type: snapped, for terminal block width: 6.2 mm, lettering field size: 6. 15 x 10.5 mm, Number of individual labels: 10

Fuse adapter

Fuse adapter - PLC-FA-I-5X20-12-24UC - 1186499

<https://www.phoenixcontact.com/de/produkte/1186499>



Safety plug adapter for use on a 6.2 mm PLC basic terminal block. For 5 x 20 mm fuses. Operating voltage: 12 ... 24 V AC/DC. With LED for fuse failure indication.

Relay Module - PLC-RSC-120UC/21

2966197

<https://www.phoenixcontact.com/de/produkte/2966197>

Zack marker strip

Zack marker strip - ZB 6,LGS:GLEICHE ZAHLEN - 1051032

<https://www.phoenixcontact.com/de/produkte/1051032>



Zack marker strip, Strip, white, labeled, can be labeled with: CMS-P1-PLOTTER, printed horizontally: Identical numbers 1 or 2, etc. up to 100, mounting type: snapped, for terminal block width: 6.2 mm, lettering field size: 6.15 x 10.5 mm, Number of individual labels: 10

Fuse adapter

Fuse adapter - PLC-FA-I-5X20-120-230UC - 1186508

<https://www.phoenixcontact.com/de/produkte/1186508>



Safety plug adapter for use on a 6.2 mm PLC basic terminal block. For 5 x 20 mm fuses. Operating voltage: 120 ... 230 V AC/DC. With LED for fuse failure indication.

Relay Module - PLC-RSC-120UC/21

2966197

<https://www.phoenixcontact.com/de/produkte/2966197>

Marker for terminal blocks

Marker for terminal blocks - ZB 6,LGS:L1-N,PE - 1051414

<https://www.phoenixcontact.com/de/produkte/1051414>



Marker for terminal blocks, Strip, white, labeled, can be labeled with: CMS-P1-PLOTTER, horizontal: L1, L2, L3, N, PE, L1, L2, L3, N, PE, mounting type: snapped, for terminal block width: 6.2 mm, lettering field size: 6.15 x 10.5 mm, Number of individual labels: 10

Marker for terminal blocks

Marker for terminal blocks - ZB 6,LGS:U-N - 1051430

<https://www.phoenixcontact.com/de/produkte/1051430>



Marker for terminal blocks, Strip, white, labeled, can be labeled with: CMS-P1-PLOTTER, printed horizontally: U, V, W, N, GND, U, V, W, N, GND, mounting type: snapped, for terminal block width: 6.2 mm, lettering field size: 6.15 x 10.5 mm, Number of individual labels: 10

Relay Module - PLC-RSC-120UC/21

2966197

<https://www.phoenixcontact.com/de/produkte/2966197>

Marker for terminal blocks

Marker for terminal blocks - UC-TM 6 - 0818085

<https://www.phoenixcontact.com/de/produkte/0818085>



Marker for terminal blocks, Sheet, white, unlabeled, can be labeled with: BLUEMARK ID COLOR, BLUEMARK ID, BLUEMARK CLED, PLOTMARK, CMS-P1-PLOTTER, mounting type: snapped, for terminal block width: 6.2 mm, lettering field size: 5.6 x 10.5 mm, Number of individual labels: 80

Marker for terminal blocks

Marker for terminal blocks - UC-TM 6 CUS - 0824589

<https://www.phoenixcontact.com/de/produkte/0824589>



Marker for terminal blocks, can be ordered: by sheet, white, labeled according to customer specifications, mounting type: snap into tall marker groove, for terminal block width: 6.2 mm, lettering field size: 5.6 x 10.5 mm, Number of individual labels: 80

Relay Module - PLC-RSC-120UC/21

2966197

<https://www.phoenixcontact.com/de/produkte/2966197>

Marker for terminal blocks

Marker for terminal blocks - UCT-TM 6 - 0828736

<https://www.phoenixcontact.com/de/produkte/0828736>



Marker for terminal blocks, Sheet, white, unlabeled, can be labeled with: TOPMARK NEO, TOPMARK LASER, BLUEMARK ID COLOR, BLUEMARK ID, BLUEMARK CLED, THERMOMARK PRIME, THERMOMARK CARD 2.0, THERMOMARK CARD, mounting type: snapped, for terminal block width: 6.2 mm, lettering field size: 5.6 x 10.5 mm, Number of individual labels: 60

Marker for terminal blocks

Marker for terminal blocks - UCT-TM 6 CUS - 0829602

<https://www.phoenixcontact.com/de/produkte/0829602>



Marker for terminal blocks, can be ordered: by sheet, white, labeled according to customer specifications, mounting type: snap into tall marker groove, for terminal block width: 6.2 mm, lettering field size: 5.6 x 10.5 mm, Number of individual labels: 60

Relay Module - PLC-RSC-120UC/21

2966197

<https://www.phoenixcontact.com/de/produkte/2966197>

DIN rail perforated

DIN rail perforated - NS 35/ 7,5 PERF 2000MM - 0801733

<https://www.phoenixcontact.com/de/produkte/0801733>



DIN rail perforated, acc. to EN 60715, material: Steel, galvanized, passivated with a thick layer, Standard profile, color: silver, Pack of 25 (50 m)

DIN rail, unperforated

DIN rail, unperforated - NS 35/ 7,5 UNPERF 2000MM - 0801681

<https://www.phoenixcontact.com/de/produkte/0801681>



DIN rail, unperforated, acc. to EN 60715, material: Steel, galvanized, passivated with a thick layer, Standard profile, color: silver, Pack of 25 (50 m)

Relay Module - PLC-RSC-120UC/21

2966197

<https://www.phoenixcontact.com/de/produkte/2966197>

DIN rail perforated

DIN rail perforated - NS 35/ 7,5 WH PERF 2000MM - 1204119

<https://www.phoenixcontact.com/de/produkte/1204119>



DIN rail perforated, acc. to EN 60715, material: Steel, Galvanized, white passivated, Standard profile, color: silver, Pack of 25 (50 m)

DIN rail, unperforated

DIN rail, unperforated - NS 35/ 7,5 WH UNPERF 2000MM-VPE 10 - 1204122

<https://www.phoenixcontact.com/de/produkte/1204122>



DIN rail, unperforated, acc. to EN 60715, material: Steel, Galvanized, white passivated, Standard profile, color: silver, Pack of 10 (20 m)

Relay Module - PLC-RSC-120UC/21

2966197

<https://www.phoenixcontact.com/de/produkte/2966197>

DIN rail, unperforated

DIN rail, unperforated - NS 35/ 7,5 AL UNPERF 2000MM - 0801704

<https://www.phoenixcontact.com/de/produkte/0801704>



DIN rail, unperforated, acc. to EN 60715, material: Aluminum, uncoated, Standard profile, color: silver, Pack of 25 (50 m)

DIN rail perforated

DIN rail perforated - NS 35/ 7,5 ZN PERF 2000MM - 1206421

<https://www.phoenixcontact.com/de/produkte/1206421>



DIN rail perforated, acc. to EN 60715, material: Steel, galvanized, Standard profile, color: silver, Pack of 25 (50 m)

Relay Module - PLC-RSC-120UC/21

2966197

<https://www.phoenixcontact.com/de/produkte/2966197>

DIN rail, unperforated

DIN rail, unperforated - NS 35/ 7,5 ZN UNPERF 2000MM - 1206434

<https://www.phoenixcontact.com/de/produkte/1206434>



DIN rail, unperforated, acc. to EN 60715, material: Steel, galvanized, Standard profile, color: silver, Pack of 25 (50 m)

DIN rail, unperforated

DIN rail, unperforated - NS 35/ 7,5 CU UNPERF 2000MM-VPE 10 - 0801762

<https://www.phoenixcontact.com/de/produkte/0801762>



DIN rail, unperforated, acc. to EN 60715, material: Copper, uncoated, Standard profile, color: copper-colored, Pack of 10 (20 m)

Relay Module - PLC-RSC-120UC/21

2966197

<https://www.phoenixcontact.com/de/produkte/2966197>

End cap

End cap - NS 35/ 7,5 CAP - 1206560

<https://www.phoenixcontact.com/de/produkte/1206560>

DIN rail end piece, for DIN rail NS 35/7.5



DIN rail perforated

DIN rail perforated - NS 35/15 PERF 2000MM - 1201730

<https://www.phoenixcontact.com/de/produkte/1201730>



DIN rail perforated, similar to EN 60715, material: Steel, galvanized, passivated with a thick layer, Standard profile, color: silver, Pack of 25 (50 m)

Relay Module - PLC-RSC-120UC/21

2966197

<https://www.phoenixcontact.com/de/produkte/2966197>

DIN rail, unperforated

DIN rail, unperforated - NS 35/15 UNPERF 2000MM - 1201714

<https://www.phoenixcontact.com/de/produkte/1201714>



DIN rail, unperforated, similar to EN 60715, material: Steel, galvanized, passivated with a thick layer, Standard profile, color: silver, Pack of 25 (50 m)

DIN rail perforated

DIN rail perforated - NS 35/15 WH PERF 2000MM - 0806602

<https://www.phoenixcontact.com/de/produkte/0806602>



DIN rail perforated, similar to EN 60715, material: Steel, Galvanized, white passivated, Standard profile, color: white, Pack of 25 (50 m)

Relay Module - PLC-RSC-120UC/21

2966197

<https://www.phoenixcontact.com/de/produkte/2966197>

DIN rail, unperforated

DIN rail, unperforated - NS 35/15 WH UNPERF 2000MM-VPE 10 - 1204135

<https://www.phoenixcontact.com/de/produkte/1204135>



DIN rail, unperforated, similar to EN 60715, material: Steel, Galvanized, white passivated, Standard profile, color: silver, Pack of 10 (20 m)

DIN rail, unperforated

DIN rail, unperforated - NS 35/15 AL UNPERF 2000MM - 1201756

<https://www.phoenixcontact.com/de/produkte/1201756>



DIN rail, unperforated, similar to EN 60715, material: Aluminum, uncoated, Standard profile, color: silver

Relay Module - PLC-RSC-120UC/21

2966197

<https://www.phoenixcontact.com/de/produkte/2966197>

DIN rail perforated

DIN rail perforated - NS 35/15 ZN PERF 2000MM - 1206599

<https://www.phoenixcontact.com/de/produkte/1206599>



DIN rail perforated, similar to EN 60715, material: Steel, galvanized, Standard profile, color: silver, Pack of 25 (50 m)

DIN rail, unperforated

DIN rail, unperforated - NS 35/15 ZN UNPERF 2000MM - 1206586

<https://www.phoenixcontact.com/de/produkte/1206586>



DIN rail, unperforated, similar to EN 60715, material: Steel, galvanized, Standard profile, color: silver, Pack of 25 (50 m)

Relay Module - PLC-RSC-120UC/21

2966197

<https://www.phoenixcontact.com/de/produkte/2966197>

DIN rail, unperforated

DIN rail, unperforated - NS 35/15 CU UNPERF 2000MM-VPE 10 - 1201895

<https://www.phoenixcontact.com/de/produkte/1201895>



DIN rail, unperforated, similar to EN 60715, material: Copper, uncoated, Standard profile, color: copper-colored, Pack of 10 (20 m)

End cap

End cap - NS 35/15 CAP - 1206573

<https://www.phoenixcontact.com/de/produkte/1206573>

DIN rail end piece, for DIN rail NS 35/15



Relay Module - PLC-RSC-120UC/21

2966197

<https://www.phoenixcontact.com/de/produkte/2966197>

DIN rail, unperforated

DIN rail, unperforated - NS 35/15-2,3 UNPERF 2000MM-VPE 10 - 1201798

<https://www.phoenixcontact.com/de/produkte/1201798>



DIN rail, unperforated, acc. to EN 60715, material: Steel, galvanized, passivated with a thick layer, Standard profile 2.3 mm, color: silver, Pack of 10 (20 m)

Relay base

Relay base - PLC-BSC-120UC/21 - 2966032

<https://www.phoenixcontact.com/de/produkte/2966032>



6.2 mm PLC basic terminal block with screw connection, without relay or solid-state relay, for mounting on DIN rail NS 35/7,5, 1 changeover contact, input voltage 120 V AC/DC

Relay Module - PLC-RSC-120UC/21



2966197

<https://www.phoenixcontact.com/de/produkte/2966197>

Single relay

Single relay - REL-MR- 60DC/21 - 2961118

<https://www.phoenixcontact.com/de/produkte/2961118>

Plug-in miniature power relay, with power contact, 1 changeover contact, input voltage 60 V DC

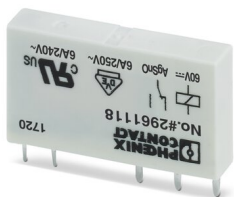

Phoenix Contact 2022 © - all rights reserved

<https://www.phoenixcontact.com>

PHOENIX CONTACT Deutschland GmbH

Flachsmarktstraße 8

D-32825 Blomberg

+49 52 35/3-1 20 00

info@phoenixcontact.de