

Contact insert - HC-B 24-I-UT-M

1648296

<https://www.phoenixcontact.com/pc/products/1648296>



Please be informed that the data shown in this PDF document is generated from our Online Catalog. Please find the complete data in the user documentation. Our General Terms of Use for Downloads are valid.

HEAVYCON pin insert, B24 series, 24-pos., screw connection

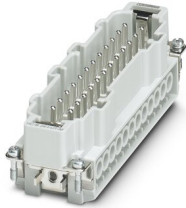

Your advantages

- For fast coding with plastic profile

- For test pin 2 mm

Contact insert - HC-B 24-I-UT-M



1648296

<https://www.phoenixcontact.com/pc/products/1648296>

Commercial Data

Item number	1648296
Packing unit	1 pc
Minimum order quantity	1 pc
Product Key	BF7ABC
Catalog Page	Page 547 (C-2-2019)
GTIN	4046356092425
Weight per Piece (including packing)	111.9 g
Weight per Piece (excluding packing)	111 g
Customs tariff number	85366990
Country of origin	CN

Contact insert - HC-B 24-I-UT-M

1648296

<https://www.phoenixcontact.com/pc/products/1648296>

Technical Data

Notes

General	for flexible conductors with or without ferrules
General	Connectors may be operated only when there is no load/voltage.

Product properties

Type	B24 B48
Product type	Contact insert with a fixed no. of positions
Number of positions	24
Connection profile	24+PE
Application	Power
Number of connections per position	1
Contact type	turned
Series	HC-B
Screwdriver blade	0.5 x 3.5 mm

Insulation characteristics

Overvoltage category	III
Degree of pollution	3

Connection data

Connection technology

Connection technology	Screw connection
Number of connections per position	1
Connection in acc. with standard	IEC / EN

Conductor connection

Connection cross section AWG	20 ... 14
Tightening torque	0.5 Nm ... 0.8 Nm
Stripping length of the individual wire	8 mm

Dimensions

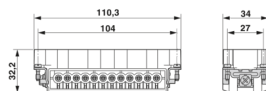
Dimensional drawing	
Width	34 mm
Height	32 mm
Length	111 mm
Drill hole distance, horizontal	104 mm
Drill hole distance, vertical	27 mm

Contact insert - HC-B 24-I-UT-M



1648296

<https://www.phoenixcontact.com/pc/products/1648296>

Mechanical characteristics

Contact diameter	2.5 mm
------------------	--------

Electrical properties

Rated voltage (III/3)	500 V
Rated surge voltage	6 kV
Rated current	16 A
SCCR	5 kA (UL 2237)

Material specifications

Flammability rating according to UL 94	V0
Contact material	Copper alloy
Contact surface material	Ag
Contact carrier material	PC
Standards/regulations	PC: Fire protection in rail vehicles - requirement sets R22, R23, and R24 acc. to DIN EN 45545-2 (Risk level HL1 - HL3)

Connector

Insertion/withdrawal cycles	≥ 500
-----------------------------	-------

Cable / line

Cable structure

Stripping length of the individual wire	8 mm
---	------

Mounting

Assembly instructions	To ensure correct use, installation in housing with IP54 protection or better is required
-----------------------	---

Ambient conditions

Ambient temperature (operation)	-40 °C ... 125 °C (including heating up of contacts)
---------------------------------	--

Standards and regulations

Constructional and testing regulations	DIN EN 61984
	DIN EN 60664
	IEC 60352
Tests	DIN EN 61984
	DIN EN 60664
	IEC 60352

Testing

Standards/regulations	PC: Fire protection in rail vehicles - requirement sets R22, R23, and R24 acc. to DIN EN 45545-2 (Risk level HL1 - HL3)
-----------------------	---

Contact insert - HC-B 24-I-UT-M

1648296

<https://www.phoenixcontact.com/pc/products/1648296>

Drawings

Diagram

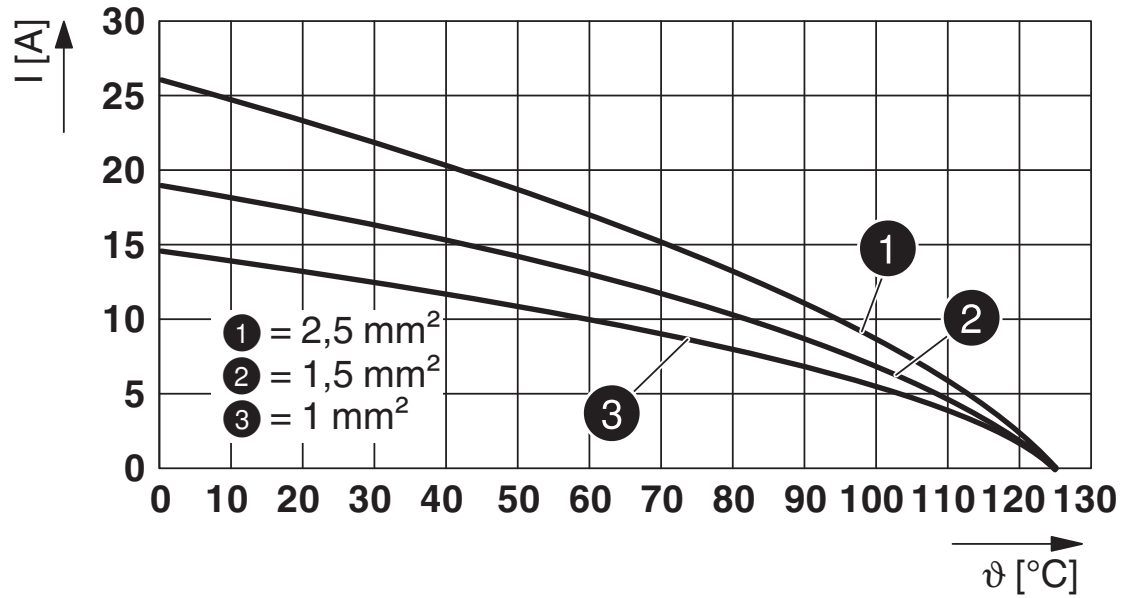

Derating diagram

Dimensional drawing

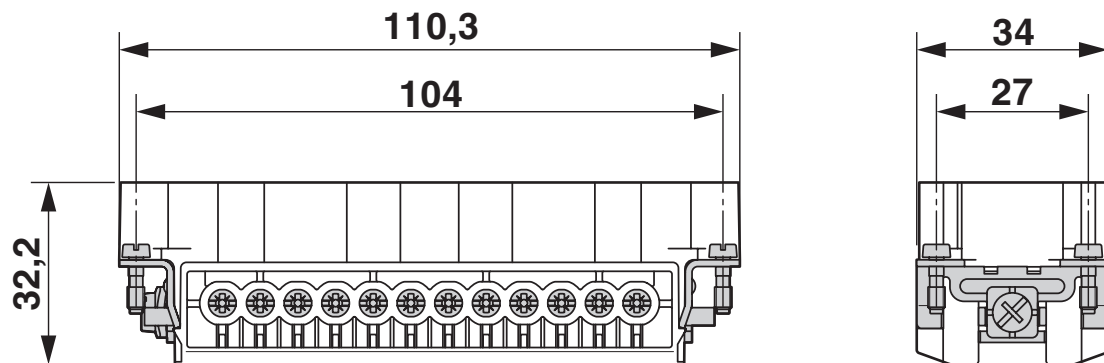

Male insert

Contact insert - HC-B 24-I-UT-M

1648296

<https://www.phoenixcontact.com/pc/products/1648296>



Dimensional drawing

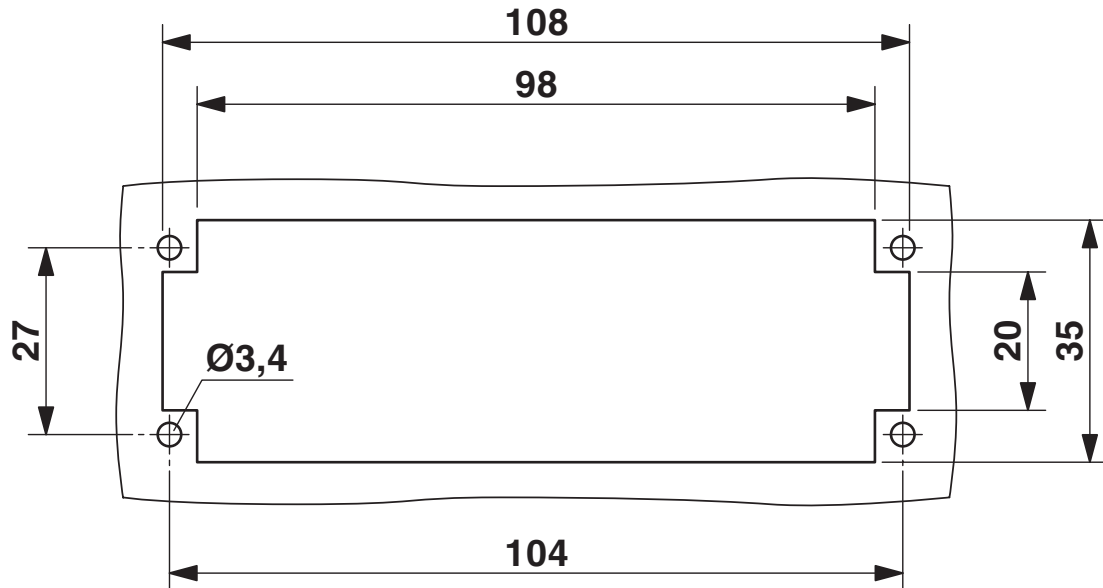

Mounting cutout when used without housing

Contact insert - HC-B 24-I-UT-M

1648296

<https://www.phoenixcontact.com/pc/products/1648296>



Schematic diagram

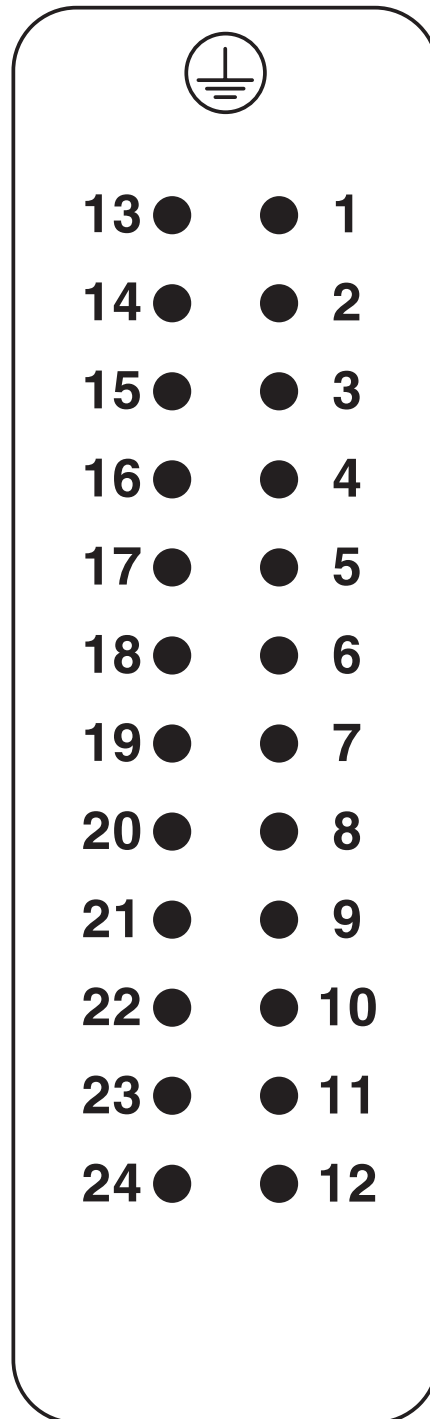

Connector pin assignment, connection side

Contact insert - HC-B 24-I-UT-M



1648296

<https://www.phoenixcontact.com/pc/products/1648296>

Approvals

DNV

Approval ID: TAE000037S



CSA

Approval ID: 013631_6233_01

Nominal Voltage U_N	Nominal Current I_N	Cross Section AWG	Cross Section mm^2
600 V	13 A	22 - 14	-



UL Recognized

Approval ID: FILE E 118976

Nominal Voltage U_N	Nominal Current I_N	Cross Section AWG	Cross Section mm^2
600 V	16 A	- 14	-



EAC

Approval ID: RU C-DE.AI30.B.01102



cULus Recognized

Approval ID: E468743

Nominal Voltage U_N	Nominal Current I_N	Cross Section AWG	Cross Section mm^2
600 V	14 A	- 14	-



EAC

Approval ID: RU C-DE.BL08.B.00511

Contact insert - HC-B 24-I-UT-M



1648296

<https://www.phoenixcontact.com/pc/products/1648296>

Classifications

ECLASS

ECLASS-9.0	27440205
ECLASS-10.0.1	27440205
ECLASS-11.0	27440205

ETIM

ETIM 8.0	EC000438
----------	----------

UNSPSC

UNSPSC 21.0	39121500
-------------	----------

Contact insert - HC-B 24-I-UT-M



1648296

<https://www.phoenixcontact.com/pc/products/1648296>

Environmental Product Compliance

REACH SVHC	Lead 7439-92-1
China RoHS	Environmentally Friendly Use Period = 50 years
	For information on hazardous substances, refer to the manufacturer's declaration available under "Downloads"

Contact insert - HC-B 24-I-UT-M

1648296

<https://www.phoenixcontact.com/pc/products/1648296>



Accessories

Coding bolt

Coding bolt - HC-CB - 1772722

<https://www.phoenixcontact.com/pc/products/1772722>



Coding pin, prevents mismating of up to six connectors with an identical number of positions

Strain relief clamp

Strain relief clamp - HC-B-ZG - 1685327

<https://www.phoenixcontact.com/pc/products/1685327>



Strain relief clamps contact inserts of series: B-, BB-, D 40, D 64, DD and HV, straight cable exit

Contact insert - HC-B 24-I-UT-M

1648296

<https://www.phoenixcontact.com/pc/products/1648296>

Strain relief clamp

Strain relief clamp - HC-B-ZS - 1685330

<https://www.phoenixcontact.com/pc/products/1685330>



Strain relief clamps contact inserts of series: B-, BB-, D 40, D 64, DD and HV, lateral cable exit

Screw

Screw - HC-B-PES - 1604997

<https://www.phoenixcontact.com/pc/products/1604997>



PE screw, for contact inserts HC-B / HC-BB / HC-DD / HC-D40 / HC-D64

Contact insert - HC-B 24-I-UT-M

1648296

<https://www.phoenixcontact.com/pc/products/1648296>



Contact insert

Contact insert - HC-B 24-I-UT-F - 1648306

<https://www.phoenixcontact.com/pc/products/1648306>

HEAVYCON female insert, B24 series, 24-pos., screw connection

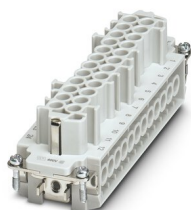

DIN rail mounting frame

DIN rail mounting frame - HC-CIF-B24-HFWL-PL - 1424337

<https://www.phoenixcontact.com/pc/products/1424337>

DIN rail mounting frame, type: B24, for contact inserts, Top frame



Contact insert - HC-B 24-I-UT-M

1648296

<https://www.phoenixcontact.com/pc/products/1648296>



DIN rail mounting frame

DIN rail mounting frame - HC-CIF-B06-24-BFAFL-PL - 1424338

<https://www.phoenixcontact.com/pc/products/1424338>



DIN rail mounting frame, type: B6 - B24, for contact inserts, Base frame

Docking frames

Docking frames - HC-B 24-ANDOCK - 1586141

<https://www.phoenixcontact.com/pc/products/1586141>



Docking frame for racks, for contact inserts of B24 type, with four M5 flat headed screws, rack balance x/y axis ± 1.5 mm

Contact insert - HC-B 24-I-UT-M

1648296

<https://www.phoenixcontact.com/pc/products/1648296>



Adapter

Adapter - HC-B-PE-PT - 1054672

<https://www.phoenixcontact.com/pc/products/1054672>



PE adapter with PT connection, for 1 PE connection, for HC-B / HC-BB / HC-DD / HC-D40 / HC-D64 contact inserts

Coding element

Coding element - HC-CST - 1676857

<https://www.phoenixcontact.com/pc/products/1676857>



Coding peg for coding up to 16 connectors

Contact insert - HC-B 24-I-UT-M

1648296

<https://www.phoenixcontact.com/pc/products/1648296>



Coding element

Coding element - HC-CBU - 1676860

<https://www.phoenixcontact.com/pc/products/1676860>



Coding socket for coding up to 16 connectors

Coding profile

Coding profile - CP-HC - 1686478

<https://www.phoenixcontact.com/pc/products/1686478>

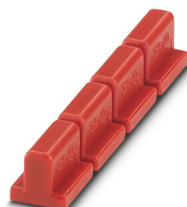

Coding profile, 4 coding profiles per strip, for insertion in coding keyways

Contact insert - HC-B 24-I-UT-M

1648296

<https://www.phoenixcontact.com/pc/products/1648296>



PE multiplier

PE multiplier - HC-B-2PE-PT - 1054675

<https://www.phoenixcontact.com/pc/products/1054675>



PE adapter with PT connection, for 2 PE connections, for HC-B / HC-BB / HC-DD / HC-D40 / HC-D64 contact inserts

PE multiplier

PE multiplier - HC-B-3PE - 1644326

<https://www.phoenixcontact.com/pc/products/1644326>



PE multiplier, for 3 PE connections, for HC-B / HC-BB / HC-DD / HC-D40 / HC-D64 contact inserts

Phoenix Contact 2022 © - all rights reserved
<https://www.phoenixcontact.com>

PHOENIX CONTACT GmbH & Co. KG
Flachsmarktstraße 8
D-32825 Blomberg
+49 (0) 5235-3 00
info@phoenixcontact.com