

Sensor/actuator cable - SAC-3P-M12MS/1,5-PUR/M 8FS



1668810

<https://www.phoenixcontact.com/de/produkte/1668810>

Please be informed that the data shown in this PDF document is generated from our Online Catalog. Please find the complete data in the user documentation. Our General Terms of Use for Downloads are valid.



Sensor/actuator cable, 3-position, PUR halogen-free, black-gray RAL 7021, Plug straight M12, coding: A, on Socket straight M8, cable length: 1.5 m

Your advantages

- Easy and safe: 100% electrically tested plug-in components

Sensor/actuator cable - SAC-3P-M12MS/1,5-PUR/M 8FS



1668810

<https://www.phoenixcontact.com/de/produkte/1668810>

Commercial Data

Item number	1668810
Packing unit	1 pc
Minimum order quantity	1 pc
Sales Key	C1 - Sensor-Aktor-Kabel
Product Key	BF1CBA
Catalog Page	Page 188 (C-2-2019)
GTIN	4017918128623
Weight per Piece (including packing)	39,1 g
Weight per Piece (excluding packing)	31,44 g
Customs tariff number	85444290
Country of origin	DE

Sensor/actuator cable - SAC-3P-M12MS/1,5-PUR/M 8FS



1668810

<https://www.phoenixcontact.com/de/produkte/1668810>

Technical Data

Product properties

Product type	Sensor/actuator cable
Number of positions	3
Application	Standard
No. of cable outlets	1
Shielded	no
Coding	A - standard

Insulation characteristics

Overvoltage category	II
Degree of pollution	3

Material specifications

Flammability rating according to UL 94	HB
Sealing material	NBR
Material of grip body	TPU, hardly inflammable, self-extinguishing
Contact material	CuSn
Contact surface material	Ni/Au
Contact carrier material	TPU GF
Cable gland material	Zinc die-cast, nickel-plated

Electrical properties

Contact resistance	$\leq 5 \text{ m}\Omega$
Insulation resistance	$\geq 100 \text{ M}\Omega$
Nominal voltage U_N	48 V AC
	60 V DC
Nominal current I_N	4 A
Protective circuit	unwired

Connection data

Conductor connection

Tightening torque	0.4 NmM12 connector
-------------------	---------------------

Connector

Insertion/withdrawal cycles	≥ 100
-----------------------------	------------

Header 1

Head design	Plug
Head cable outlet	straight
Head thread type	M12
Coding	A

Header 2

Sensor/actuator cable - SAC-3P-M12MS/1,5-PUR/M 8FS



1668810

<https://www.phoenixcontact.com/de/produkte/1668810>

Head design	Socket
Head cable outlet	straight
Head thread type	M8

LED signaling

Status display	No
Status display present	No

Cable / line

Cable length	1.5 m
Cable weight	18 kg/km
UL AWM Style	20549 / 10493 (80°C/300 V)
Number of positions	3
Shielded	no
Cable type	PUR halogen-free black [PUR]
Conductor structure signal line	32x 0.10 mm
AWG signal line	24
Conductor cross section	3x 0.25 mm ²
Wire diameter incl. insulation	1.17 mm ±0.02 mm
External cable diameter	3.6 mm ±0.15 mm
Outer sheath, material	PUR
External sheath, color	black-gray RAL 7021
Conductor material	Bare Cu litz wires
Material wire insulation	PP
Single wire, color	brown, blue, black
Thickness, insulation	≥ 0.21 mm (Core insulation)
Thickness, outer sheath	approx. 0.5 mm
Overall twist	3 wires, twisted
Length of twist, overall twist	40 mm
Max. conductor resistance	≤ 78 Ω/km (at 20 °C)
Insulation resistance	≥ 100 GΩ*km (at 20 °C)
Nominal voltage, cable	≤ 300 V
Test voltage	≥ 3000 V
Smallest bending radius, fixed installation	18 mm
Smallest bending radius, movable installation	36 mm
Max. bending cycles	10000000
Halogen-free	in accordance with DIN VDE 0472 part 815
Flame resistance	in accordance with UL 758/1581 FT2 DIN EN 60332-2-2 (20 s)
Resistance to oil	in accordance with DIN EN 60811-2-1
Other resistance	hydrolysis and microbe resistant Highly resistant to acids, alkaline solutions and solvents Resistant to salt water partly UV-resistant in accordance with DIN EN ISO 4892-2-A

Sensor/actuator cable - SAC-3P-M12MS/1,5-PUR/M 8FS



1668810

<https://www.phoenixcontact.com/de/produkte/1668810>

Special properties	Flexible cable conduit capable
	Silicone-free
	Free of substances which would hinder coating with paint or varnish
Ambient temperature (operation)	-40 °C ... 80 °C (cable, fixed installation)
	-25 °C ... 80 °C (Cable, flexible installation)
Cable weight	23 kg/km

Cable structure

Cable abbreviation	Li9Y11Y-HF
Cable type	PUR halogen-free black
External cable diameter	4.40 mm
Outer sheath, material	PUR
External sheath, color	black-gray RAL 7021
Conductor material	Bare Cu litz wires
Conductor structure signal line	32x 0.10 mm
AWG signal line	24
Material wire insulation	PP
Thickness, insulation	≥ 0.38 mm (Core insulation)
Wire diameter incl. insulation	1.15 mm ±0.05 mm
Single wire, color	brown, blue, black
Overall twist	3 wires, twisted

Electrical properties

Nominal voltage, cable	300 V
Test voltage, cable	4000 V
Conductor resistance	≤ 77.6 Ω/m
Cable insulation resistance	≥ 100 GΩ*km

Mechanical properties

Smallest bending radius, movable installation	44 mm
Number of bending cycles	4000000
Bending radius	44 mm
Traversing path	10 m
Traversing rate	3 m/s

Bending cycles

Smallest bending radius, movable installation	44 mm
Number of bending cycles	4000000
Bending radius	44 mm
Traversing path	10 m
Traversing rate	3 m/s

Ambient conditions

Ambient temperature (operation)	-5 °C ... 80 °C (Cable, flexible installation)
	-40 °C ... 80 °C (cable, fixed installation)

Sensor/actuator cable - SAC-3P-M12MS/1,5-PUR/M 8FS



1668810

<https://www.phoenixcontact.com/de/produkte/1668810>

Ambient conditions

Degree of protection	IP65
	IP67
	IP68
Ambient temperature (operation)	-25 °C ... 90 °C (Plug / socket)
	-40 °C ... 80 °C (cable, fixed installation)
	-5 °C ... 80 °C (Cable, flexible installation)

Standards and regulations

Standards/specifications	IEC 61076-2-101
Standards/specifications	IEC 61076-2-104

Sensor/actuator cable - SAC-3P-M12MS/1,5-PUR/M 8FS

1668810

<https://www.phoenixcontact.com/de/produkte/1668810>

Drawings

Schematic diagram

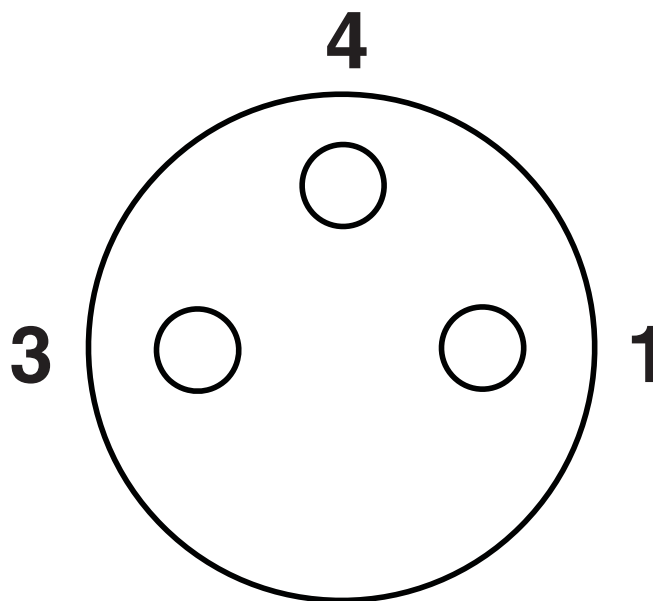

Pin assignment M8 socket, 3-pos., view female side

Dimensional drawing

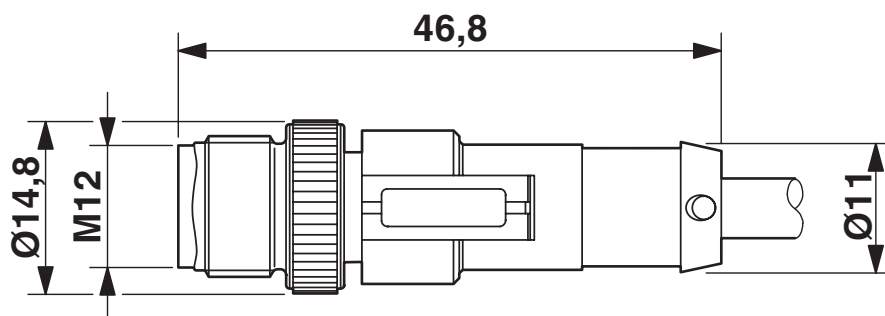

Plug, M12 x 1, straight, shielded

Sensor/actuator cable - SAC-3P-M12MS/1,5-PUR/M 8FS

1668810

<https://www.phoenixcontact.com/de/produkte/1668810>

Schematic diagram

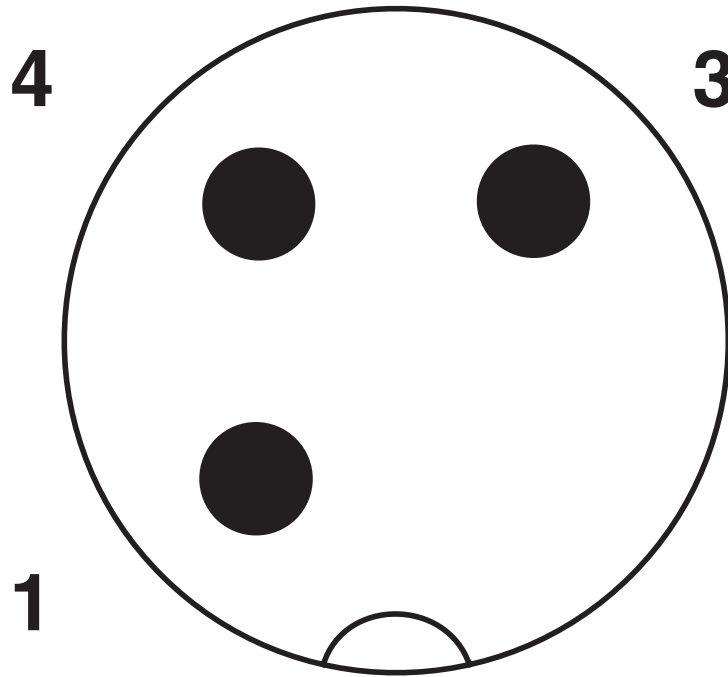

Pin assignment M12 plug, 3-pos., A-coded, view male side

Dimensional drawing

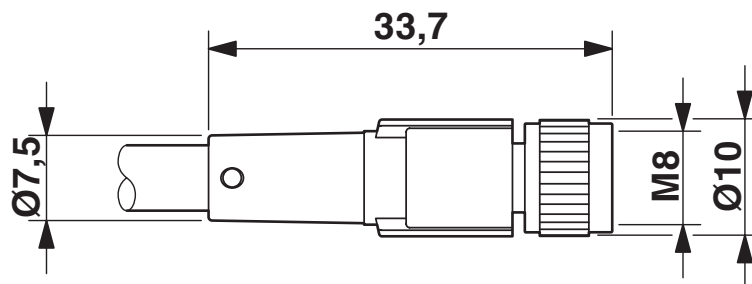

Socket M8 x 1, straight

Sensor/actuator cable - SAC-3P-M12MS/1,5-PUR/M 8FS



1668810

<https://www.phoenixcontact.com/de/produkte/1668810>

Circuit diagram

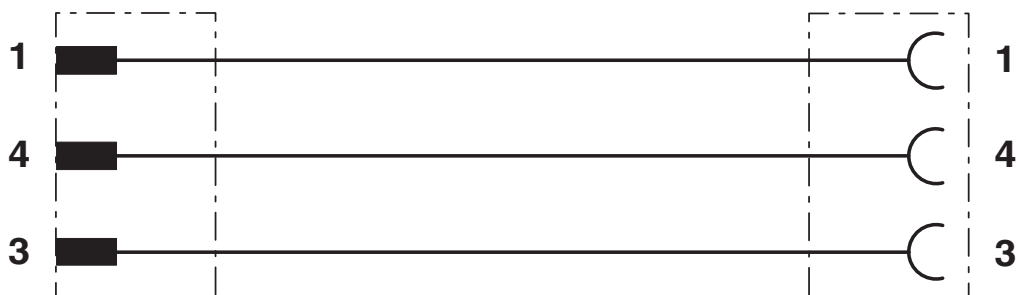

Contact assignment of M12 plugs / M8 sockets

Sensor/actuator cable - SAC-3P-M12MS/1,5-PUR/M 8FS



1668810

<https://www.phoenixcontact.com/de/produkte/1668810>

Approvals

 UL Listed Approval ID: FILE E 221474				
	Nominal Voltage U_N	Nominal Current I_N	Cross Section AWG	Cross Section mm^2
	60 V	4 A	-	-

 cUL Listed Approval ID: FILE E 221474				
	Nominal Voltage U_N	Nominal Current I_N	Cross Section AWG	Cross Section mm^2
	60 V	4 A	-	-

 EAC Approval ID: RU D-DE.HB35.B.00387	
---	--

cULus Listed

Sensor/actuator cable - SAC-3P-M12MS/1,5-PUR/M 8FS



1668810

<https://www.phoenixcontact.com/de/produkte/1668810>

Classifications

ECLASS

ECLASS-9.0	27060311
ECLASS-10.0.1	27060311
ECLASS-11.0	27060311

ETIM

ETIM 8.0	EC001855
----------	----------

UNSPSC

UNSPSC 21.0	26121600
-------------	----------

Sensor/actuator cable - SAC-3P-M12MS/1,5-PUR/M 8FS



1668810

<https://www.phoenixcontact.com/de/produkte/1668810>

Environmental Product Compliance

China RoHS

Environmentally friendly use period: unlimited = EFUP-e

No hazardous substances above threshold values

Sensor/actuator cable - SAC-3P-M12MS/1,5-PUR/M 8FS



1668810

<https://www.phoenixcontact.com/de/produkte/1668810>

Accessories

Sealing cap

Sealing cap - PROT-M12 FS-PA-CHAIN - 1430873

<https://www.phoenixcontact.com/de/produkte/1430873>

M12 sealing cap made of plastic with fixing band, for sensor cables, for free M12 plugs



Locking clip

Locking clip - SAC-M12-EXCLIP-M - 1558988

<https://www.phoenixcontact.com/de/produkte/1558988>

Locking clip for the pin side of sensor/actuator cables with M12 connector and M12 connectors for assembly, for knurl diameter: 15 mm or for Allen key with a wrench size of 14 mm, prevents the disconnection of plug-in connections without tools



Sensor/actuator cable - SAC-3P-M12MS/1,5-PUR/M 8FS

1668810

<https://www.phoenixcontact.com/de/produkte/1668810>

Insert label

Insert label - PABA WH/23 - 1013779

<https://www.phoenixcontact.com/de/produkte/1013779>



Insert label, Strip, white, unlabeled, can be labeled with: CMS-P1-PLOTTER, mounting type: slide-on, cable diameter range: 1.5 ... 35 mm, lettering field size: 23 x 4 mm, Number of individual labels: 20

Insert label

Insert label - PABA YE/23 - 1013782

<https://www.phoenixcontact.com/de/produkte/1013782>



Insert label, Strip, yellow, unlabeled, can be labeled with: CMS-P1-PLOTTER, mounting type: slide-on, cable diameter range: 1.5 ... 35 mm, lettering field size: 23 x 4 mm, Number of individual labels: 20

Sensor/actuator cable - SAC-3P-M12MS/1,5-PUR/M 8FS



1668810

<https://www.phoenixcontact.com/de/produkte/1668810>

Marker pen

Marker pen - B-STIFT - 1051993

<https://www.phoenixcontact.com/de/produkte/1051993>



Marker pen, for manual labeling of unprinted Zack strips, smear-proof and waterproof, line thickness 0.5 mm

Screw plug

Screw plug - PROT-M 8 MS-PA-CHAIN - 1430860

<https://www.phoenixcontact.com/de/produkte/1430860>



M8 sealing cap made of plastic with fixing band for sensor cables, for M8 sockets

Sensor/actuator cable - SAC-3P-M12MS/1,5-PUR/M 8FS

1668810

<https://www.phoenixcontact.com/de/produkte/1668810>

Torque screwdriver

Torque screwdriver - TSD 02 SAC - 1208487

<https://www.phoenixcontact.com/de/produkte/1208487>



Torque screwdriver, with preset torque of 0.2 Nm and 4 mm hexagonal drive for M8 connectors

Tool

Tool - SAC BIT M8-D10 - 1208461

<https://www.phoenixcontact.com/de/produkte/1208461>



Nut for assembling M8 connectors with longitudinal knurl and a knurl diameter of 10 mm, for 4 mm hexagonal drive

Sensor/actuator cable - SAC-3P-M12MS/1,5-PUR/M 8FS

1668810

<https://www.phoenixcontact.com/de/produkte/1668810>

Torque screwdriver

Torque screwdriver - TSD 04 SAC - 1208429

<https://www.phoenixcontact.com/de/produkte/1208429>



Torque screwdriver, with preset torque of 0.4 Nm and 4 mm hexagonal drive for M12 connectors

Torque screwdriver

Torque screwdriver - TSD-M 1,2NM - 1212224

<https://www.phoenixcontact.com/de/produkte/1212224>



Torque screw driver, accuracy as per EN ISO 6789 standard, adjustable from 0.3 - 1.2 Nm

Sensor/actuator cable - SAC-3P-M12MS/1,5-PUR/M 8FS



1668810

<https://www.phoenixcontact.com/de/produkte/1668810>

Adapter insert

Adapter insert - TSD-M SAC-BIT ADAPTER - 1212600

<https://www.phoenixcontact.com/de/produkte/1212600>



Adapter bit for TSD-M...torque tools, E6.3-1/4" drive with 4 mm hexagon to accommodate SAC bits

Tool

Tool - SAC BIT M12-D15 - 1208432

<https://www.phoenixcontact.com/de/produkte/1208432>



Nut for assembling sensor/actuator cables with M12 connector and M12 connectors for assembly, with a knurl diameter of 15 mm, for 4 mm hexagonal drive

Phoenix Contact 2022 © - all rights reserved
<https://www.phoenixcontact.com>

PHOENIX CONTACT Deutschland GmbH
Flachsmarktstraße 8
D-32825 Blomberg
+49 52 35/3-1 20 00
info@phoenixcontact.de