

Connector - SACC-M12MS-5CON-PG 9-SH



1694266

<https://www.phoenixcontact.com/pc/products/1694266>

Please be informed that the data shown in this PDF document is generated from our Online Catalog. Please find the complete data in the user documentation. Our General Terms of Use for Downloads are valid.



Connector, Universal, 5-position, shielded, Plug straight M12, Coding: A, Screw connection, knurl material: Zinc die-cast, nickel-plated, cable gland Pg9, external cable diameter 6 mm ... 8 mm

Your advantages

- Safe use in the field, thanks to a high degree of protection
- Screw connection: proven connection technology for a large selection of different conductors
- Reliable signal transmission - 360° shielding in environments with electromagnetic interference

Connector - SACC-M12MS-5CON-PG 9-SH



1694266

<https://www.phoenixcontact.com/pc/products/1694266>

Commercial Data

Item number	1694266
Packing unit	1 pc
Minimum order quantity	1 pc
Sales Key	02
Product Key	BF2CBA
Catalog Page	Page 24 (C-2-2019)
GTIN	4017918181260
Weight per Piece (including packing)	45.9 g
Weight per Piece (excluding packing)	45.9 g
Customs tariff number	85366990
Country of origin	DE

Connector - SACC-M12MS-5CON-PG 9-SH



1694266

<https://www.phoenixcontact.com/pc/products/1694266>

Technical Data

Notes

Assembly instruction:

NOTE: Observe the permissible bending radii when laying conductors, since the degree of protection may be put in jeopardy if the bending forces are too high. Alleviate mechanical loads upstream of the connector, e.g. by using cable ties.

Product properties

Product type	Circular connector (cable-side)
Number of positions	5
No. of cable outlets	1
Shielded	yes
Coding	A - standard
Cable outlet	straight
Pg screw connection	Pg9

Insulation characteristics

Overvoltage category	II
Degree of pollution	3

Ambient conditions

Degree of protection	IP67
Ambient temperature (operation)	-40 °C ... 85 °C (Plug / socket)

Dimensions

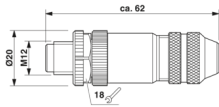
Dimensional drawing	
Length	62 mm

External dimensions

Outside diameter	6 mm ... 8 mm
------------------	---------------

Housing

Diameter housing	20 mm
------------------	-------

Connector

Insertion/withdrawal cycles	≥ 100
-----------------------------	-------

Header 1

Head design	Plug
Head cable outlet	straight
Head thread type	M12

Connector - SACC-M12MS-5CON-PG 9-SH



1694266

<https://www.phoenixcontact.com/pc/products/1694266>

Coding	A-coded
Number of positions	5
Coding	A - standard
Insertion/withdrawal cycles	≥ 100
Connection method	Screw connection
Contact material	CuZn
Contact surface material	Au
Number of positions	5
Coding	A - standard
Insertion/withdrawal cycles	≥ 100
Connection method	Screw connection
Contact material	CuZn
Contact surface material	Au

Electrical properties

Rated surge voltage	1.5 kV
Contact resistance	≤ 3 mΩ
Insulation resistance	≥ 100 MΩ
Nominal voltage U _N	48 V AC
	60 V DC
Nominal current I _N	4 A

Material specifications

Flammability rating according to UL 94	HB
Sealing material	NBR
Material of grip body	Zinc die-cast, nickel-plated
Contact material	CuZn
Contact surface material	Au
Contact carrier material	PA
Cable gland material	Zinc die-cast, nickel-plated

Connection data

Conductor connection

Connection method	Screw connection
Conductor cross section flexible	0.25 mm ² ... 0.75 mm ²
Cross section AWG	24 ... 18

Standards and regulations

M12

Standards/specifications	IEC 61076-2-101
--------------------------	-----------------

Cable / line

Cable structure

Connector - SACC-M12MS-5CON-PG 9-SH



1694266

<https://www.phoenixcontact.com/pc/products/1694266>

Signal type/category	Universal
Stripping length of the individual wire	5 mm

Connector - SACC-M12MS-5CON-PG 9-SH

1694266

<https://www.phoenixcontact.com/pc/products/1694266>

Drawings

Schematic diagram

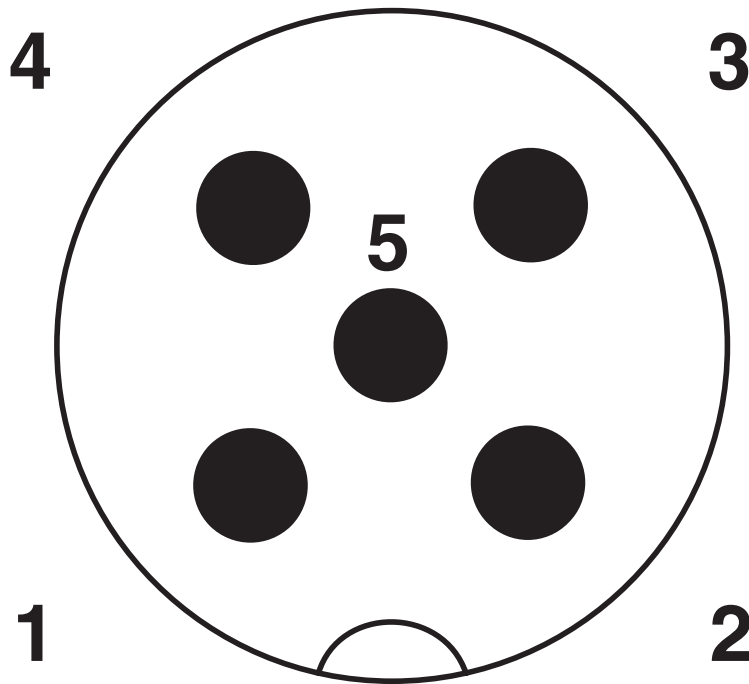

Pin assignment M12 male connector, 5-pos., A-coded, male side

Dimensional drawing

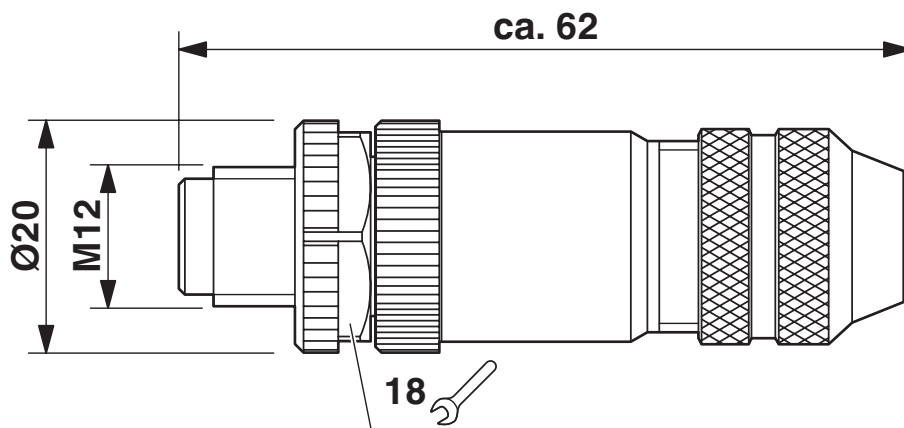

Plug, M12 x 1, straight, shielded

1694266

<https://www.phoenixcontact.com/pc/products/1694266>

Schematic diagram

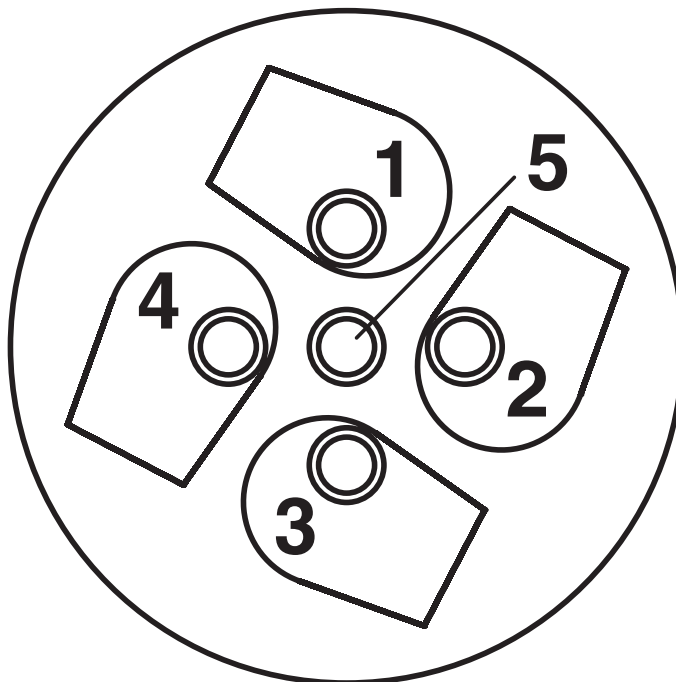

Cable connection side M12 (screw connection)

Functional drawing

Assembly steps for M 12 male/female connector and conductor

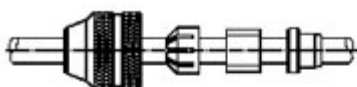

Slide parts onto the conductor

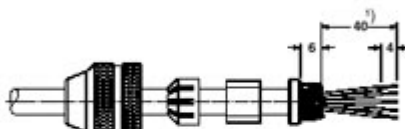

Strip conductor, widen shield and lay around the shielding ring, cut off projecting mesh.

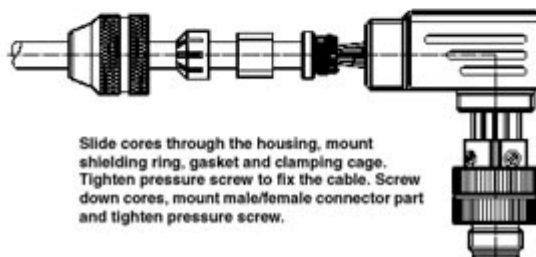

Slide cores through the housing, mount shielding ring, gasket and clamping cage. Tighten pressure screw to fix the cable. Screw down cores, mount male/female connector part and tighten pressure screw.

Connector - SACC-M12MS-5CON-PG 9-SH



1694266

<https://www.phoenixcontact.com/pc/products/1694266>

Approvals

 cUL Recognized Approval ID: FILE E 221474				
	Nominal Voltage U_N	Nominal Current I_N	Cross Section AWG	Cross Section mm^2
	125 V	4 A	-	-

 UL Recognized Approval ID: FILE E 221474				
	Nominal Voltage U_N	Nominal Current I_N	Cross Section AWG	Cross Section mm^2
	125 V	4 A	-	-

cULus Recognized

Connector - SACC-M12MS-5CON-PG 9-SH



1694266

<https://www.phoenixcontact.com/pc/products/1694266>

Classifications

ECLASS

ECLASS-10.0.1	27440102
ECLASS-9.0	27440102
ECLASS-11.0	27440102

ETIM

ETIM 8.0	EC002635
----------	----------

UNSPSC

UNSPSC 21.0	39121400
-------------	----------

Connector - SACC-M12MS-5CON-PG 9-SH



1694266

<https://www.phoenixcontact.com/pc/products/1694266>

Environmental Product Compliance

REACH SVHC	Lead 7439-92-1
China RoHS	Environmentally Friendly Use Period = 50 years
	For information on hazardous substances, refer to the manufacturer's declaration available under "Downloads"

Connector - SACC-M12MS-5CON-PG 9-SH



1694266

<https://www.phoenixcontact.com/pc/products/1694266>

Accessories

Cable reel

Cable reel - SAC-5P-100,0-PUR/SH-0,34 - 1501728

<https://www.phoenixcontact.com/pc/products/1501728>



By the meter, Cable reel, shielded, PUR halogen-free, black-gray RAL 7021, 5-wire, color single wire: Brown, white, blue, black, gray, cable length: 100 m

Screwdriver

Screwdriver - SZF 1-0,6X3,5 - 1204517

<https://www.phoenixcontact.com/pc/products/1204517>



Actuation tool, for ST terminal blocks, also suitable for use as a bladed screwdriver, size: 0.6 x 3.5 x 100 mm, 2-component grip, with non-slip grip

Connector - SACC-M12MS-5CON-PG 9-SH

1694266

<https://www.phoenixcontact.com/pc/products/1694266>

Ferrule

Ferrule - A 0,25- 5 - 3202465

<https://www.phoenixcontact.com/pc/products/3202465>

Ferrule, length: 5 mm, color: silver



Stripping tool

Stripping tool - WIREFOX SAC - 1212623

<https://www.phoenixcontact.com/pc/products/1212623>

Stripping pliers, for halogen-free sensor/actuator cables (SAC cables), with PUR and PVC insulation, from Ø of 4.4 to 7 mm, any stripping length



Connector - SACC-M12MS-5CON-PG 9-SH



1694266

<https://www.phoenixcontact.com/pc/products/1694266>

Stripping tool

Stripping tool - VS-CABLE-STRIP-VARIO - 1657407

<https://www.phoenixcontact.com/pc/products/1657407>

Stripping tool, for the multi-level stripping of shielded cables



Torque screwdriver

Torque screwdriver - TSD 04 SAC - 1208429

<https://www.phoenixcontact.com/pc/products/1208429>

Torque screwdriver, with preset torque of 0.4 Nm and 4 mm hexagonal drive for M12 connectors



Connector - SACC-M12MS-5CON-PG 9-SH



1694266

<https://www.phoenixcontact.com/pc/products/1694266>

Torque screwdriver

Torque screwdriver - TSD-M 1,2NM - 1212224

<https://www.phoenixcontact.com/pc/products/1212224>



Torque screw driver, accuracy as per EN ISO 6789 standard, adjustable from 0.3 - 1.2 Nm

Adapter insert

Adapter insert - TSD-M SAC-BIT ADAPTER - 1212600

<https://www.phoenixcontact.com/pc/products/1212600>



Adapter bit for TSD-M...torque tools, E6.3-1/4" drive with 4 mm hexagon to accommodate SAC bits

Connector - SACC-M12MS-5CON-PG 9-SH



1694266

<https://www.phoenixcontact.com/pc/products/1694266>

Sealing cap

Sealing cap - PROT-M12 FS-PA-CHAIN - 1430873

<https://www.phoenixcontact.com/pc/products/1430873>

M12 sealing cap made of plastic with fixing band, for sensor cables, for free M12 plugs



Crimping pliers

Crimping pliers - CRIMPFOX 6H - 1212046

<https://www.phoenixcontact.com/pc/products/1212046>

Crimping pliers, for ferrules without insulating collar according to DIN 46228 Part 1 and ferrules with insulating collar according to DIN 46228 Part 4, 0.14 mm² ... 6 mm², unlockable pressure lock, lateral entry



Connector - SACC-M12MS-5CON-PG 9-SH



1694266

<https://www.phoenixcontact.com/pc/products/1694266>

Tool

Tool - SACC BIT M12-D20 - 1208445

<https://www.phoenixcontact.com/pc/products/1208445>

Nut for assembling M12 connectors for assembly with a knurl diameter of 20 mm, for 4 mm hexagonal drive



Phoenix Contact 2022 © - all rights reserved

<https://www.phoenixcontact.com>

PHOENIX CONTACT GmbH & Co. KG

Flachsmarktstraße 8

D-32825 Blomberg

+49 (0) 5235-3 00

info@phoenixcontact.com