

PCB connector - MSTB 2,5/ 2-ST

1754449

<https://www.phoenixcontact.com/de/produkte/1754449>

Please be informed that the data shown in this PDF document is generated from our Online Catalog. Please find the complete data in the user documentation. Our General Terms of Use for Downloads are valid.



PCB connector, nominal cross section: 2.5 mm², color: green, nominal current: 12 A, rated voltage (III/2): 320 V, contact surface: Tin, type of contact: Female connector, number of potentials: 2, number of rows: 1, number of positions: 2, number of connections: 2, product range: MSTB 2,5/...-ST, pitch: 5 mm, connection method: Screw connection with tension sleeve, screw head form: L Slotted, conductor/PCB connection direction: 0 °, locking clip: - Locking clip, plug-in system: COMBICON MSTB 2,5, locking: without, mounting: without, type of packaging: packed in cardboard

Your advantages

- Well-known connection principle allows worldwide use
- Low temperature rise, thanks to maximum contact force
- Allows connection of two conductors

PCB connector - MSTB 2,5/ 2-ST



1754449

<https://www.phoenixcontact.com/de/produkte/1754449>

Commercial Data

Item number	1754449
Packing unit	100 pc
Minimum order quantity	100 pc
Sales Key	E1 - Leiterplattenanschl.
Product Key	AACAFC
Catalog Page	Page 262 (C-1-2013)
GTIN	4017918028619
Weight per Piece (including packing)	3,444 g
Weight per Piece (excluding packing)	3,444 g
Customs tariff number	85366990
Country of origin	DE

PCB connector - MSTB 2,5/ 2-ST



1754449

<https://www.phoenixcontact.com/de/produkte/1754449>

Technical Data

Product properties

Type	Standard
Product line	COMBICON Connectors M
Product type	PCB plug
Number of positions	2
Pitch	5 mm
Number of connections	2
Number of rows	1
Mounting flange	without
Number of potentials	2

Electrical properties

Nominal current I_N	12 A
Nominal voltage U_N	320 V
Pollution degree	3
Contact resistance	1.4 mΩ
Rated voltage (III/3)	250 V
Rated surge voltage (III/3)	4 kV
Rated voltage (III/2)	320 V
Rated surge voltage (III/2)	4 kV

Connection data

Connection technology

Type	Standard
Connector system	COMBICON MSTB 2,5
Nominal cross section	2.5 mm ²
Type of contact	Female connector

Interlock

Locking type	without
Mounting flange	without

Conductor connection

Connection method	Screw connection with tension sleeve
Conductor/PCB connection direction	0 °
Conductor cross section solid	0.2 mm ² ... 2.5 mm ²
Conductor cross section flexible	0.2 mm ² ... 2.5 mm ²
Conductor cross section AWG	24 ... 12
Conductor cross section flexible, with ferrule without plastic sleeve	0.25 mm ² ... 2.5 mm ²
Conductor cross section, flexible, with ferrule, with plastic sleeve	0.25 mm ² ... 2.5 mm ²
2 conductors with same cross section, solid	0.2 mm ² ... 1 mm ²

PCB connector - MSTB 2,5/ 2-ST

1754449

<https://www.phoenixcontact.com/de/produkte/1754449>

2 conductors with same cross section, flexible	0.2 mm ² ... 1.5 mm ²
2 conductors with same cross section, flexible, with ferrule without plastic sleeve	0.25 mm ² ... 1 mm ²
2 conductors with the same cross section, flexible, with TWIN ferrule with plastic sleeve	0.5 mm ² ... 1.5 mm ²
Cylindrical gauge a x b / diameter	2.8 mm x 2.0 mm / 2.4 mm
Stripping length	7 mm
Torque	0.5 Nm ... 0.6 Nm

Material specifications

Material data - contact

Note	WEEE/RoHS-compliant, free of whiskers according to IEC 60068-2-82/JEDEC JESD 201
Contact material	Cu alloy
Surface characteristics	hot-dip tin-plated
Metal surface terminal point (top layer)	Tin (5 - 7 µm Sn)
Metal surface contact area (top layer)	Tin (5 - 7 µm Sn)

Material data - housing

Housing color	green (6021)
Insulating material	PA
Insulating material group	I
CTI according to IEC 60112	600
Flammability rating according to UL 94	V0
Glow wire flammability index GWFI according to EN 60695-2-12	850
Glow wire ignition temperature GWIT according to EN 60695-2-13	775
Temperature for the ball pressure test according to EN 60695-10-2	125 °C

Dimensions

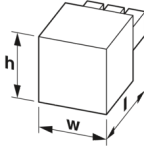
Dimensional drawing	
Pitch	5 mm
Width [w]	10 mm
Height [h]	15 mm
Length [l]	18.2 mm
Installed height	15 mm

Mounting

Drive form screw head	Slotted (L)
-----------------------	-------------

Notes

Notes on operation	In accordance with IEC 61984, COMBICON connectors have no switching power (COC). During designated use, they must not be plugged in or disconnected when carrying voltage or under load.
--------------------	--

Mechanical tests

Test for conductor damage and slackening

Specification	IEC 60999-1:1999-11
Result	Test passed

Pull-out test

Specification	IEC 60999-1:1999-11
Conductor cross section/conductor type/tractive force setpoint/actual value	0.2 mm ² / solid / > 10 N
	0.2 mm ² / flexible / > 10 N
	2.5 mm ² / solid / > 50 N
	2.5 mm ² / flexible / > 50 N

Insertion and withdrawal forces

Result	Test passed
No. of cycles	25
Insertion strength per pos. approx.	8 N
Withdraw strength per pos. approx.	6 N

Torque test

Specification	IEC 60999-1:1999-11
---------------	---------------------

Contact holder in insert

Specification	IEC 60512-15-1:2008-05
Contact holder in insert Requirements >20 N	Test passed

Resistance of inscriptions

Specification	IEC 60068-2-70:1995-12
Result	Test passed

Polarization and coding

Specification	IEC 60512-13-5:2006-02
Result	Test passed

Visual inspection

Specification	IEC 60512-1-1:2002-02
Result	Test passed

Dimension check

Specification	IEC 60512-1-2:2002-02
Result	Test passed

Environmental and real-life conditions

Vibration test

Specification	IEC 60068-2-6:2007-12
Frequency	10 - 150 - 10 Hz
Sweep speed	1 octave/min
Amplitude	0.35 mm (10 - 60.1 Hz)
Sweep speed	5g (60.1 - 150 Hz)
Test duration per axis	2.5 h

Durability test

Specification	IEC 60512-9-1:2010-03
Impulse withstand voltage at sea level	4.8 kV
Contact resistance R_1	1.4 m Ω
Contact resistance R_2	1.5 m Ω
Insertion/withdrawal cycles	25
Insulation resistance, neighboring positions	> 5 M Ω

Climatic test

Specification	ISO 6988:1985-02
Corrosive stress	0.2 dm ³ SO ₂ on 300 dm ³ /40 °C/1 cycle
Thermal stress	100 °C/168 h
Power-frequency withstand voltage	2.21 kV

Ambient conditions

Ambient temperature (operation)	-40 °C ... 100 °C (dependent on the derating curve)
Ambient temperature (storage/transport)	-40 °C ... 70 °C
Relative humidity (storage/transport)	30 % ... 70 %
Ambient temperature (assembly)	-5 °C ... 100 °C

Electrical tests

Thermal test | Test group C

Specification	IEC 60512-5-1:2002-02
Tested number of positions	24

Insulation resistance

Specification	IEC 60512-3-1:2002-02
Insulation resistance, neighboring positions	> 5 M Ω

Air clearances and creepage distances |

Specification	IEC 60664-1:2007-04
Insulating material group	I
Comparative tracking index (IEC 60112)	CTI 600
Rated insulation voltage (III/3)	250 V
Rated surge voltage (III/3)	4 kV

PCB connector - MSTB 2,5/ 2-ST



1754449

<https://www.phoenixcontact.com/de/produkte/1754449>

minimum clearance value - non-homogenous field (III/3)	3 mm
minimum creepage distance (III/3)	3.2 mm
Rated insulation voltage (III/2)	320 V
Rated surge voltage (III/2)	4 kV
minimum clearance value - non-homogenous field (III/2)	3 mm
minimum creepage distance (III/2)	3 mm
Rated insulation voltage (II/2)	630 V
Rated surge voltage (II/2)	4 kV
minimum clearance value - non-homogenous field (II/2)	3 mm
minimum creepage distance (II/2)	3.2 mm

Packaging specifications

Type of packaging	packed in cardboard
-------------------	---------------------

Drawings

Diagram

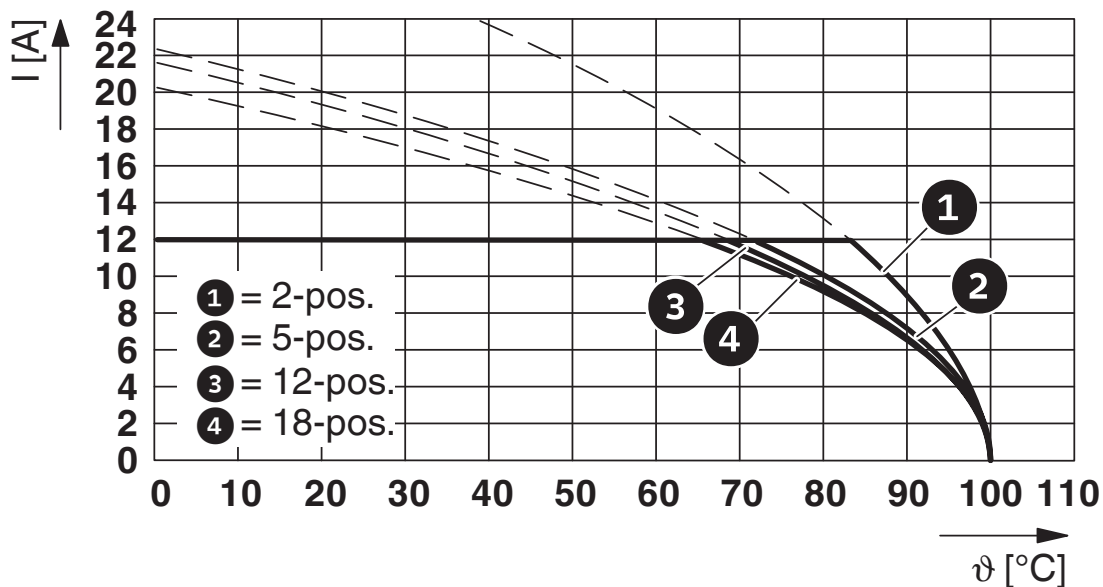

Type: MSTB 2,5/...-ST with FKIC 2,5/...-ST

Diagram

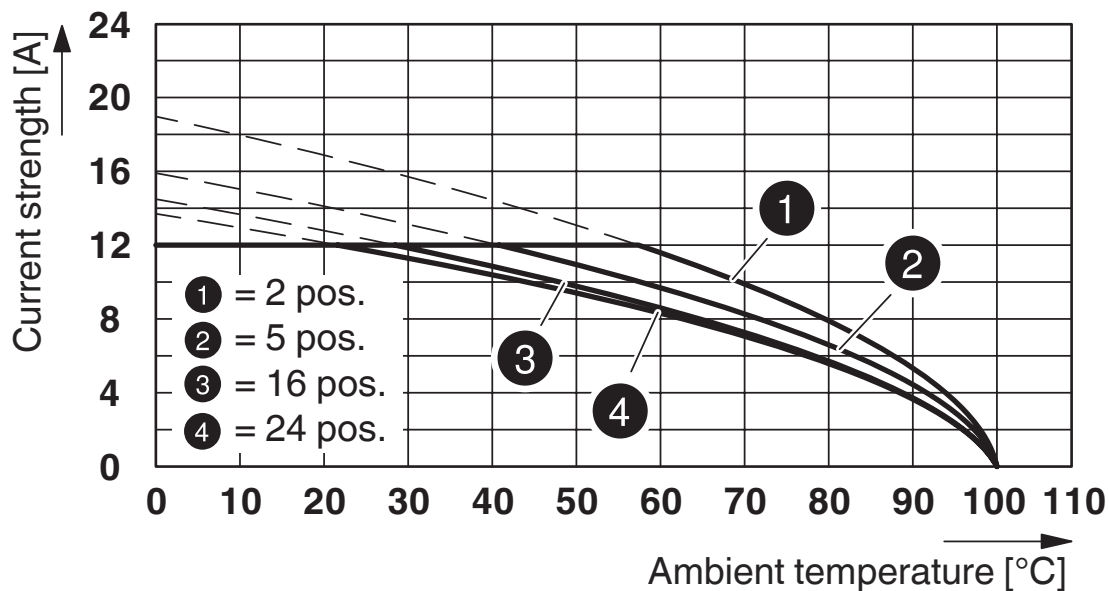

Type: MSTB 2,5/...-ST with MSTBV 2,5/...-G

1754449

<https://www.phoenixcontact.com/de/produkte/1754449>

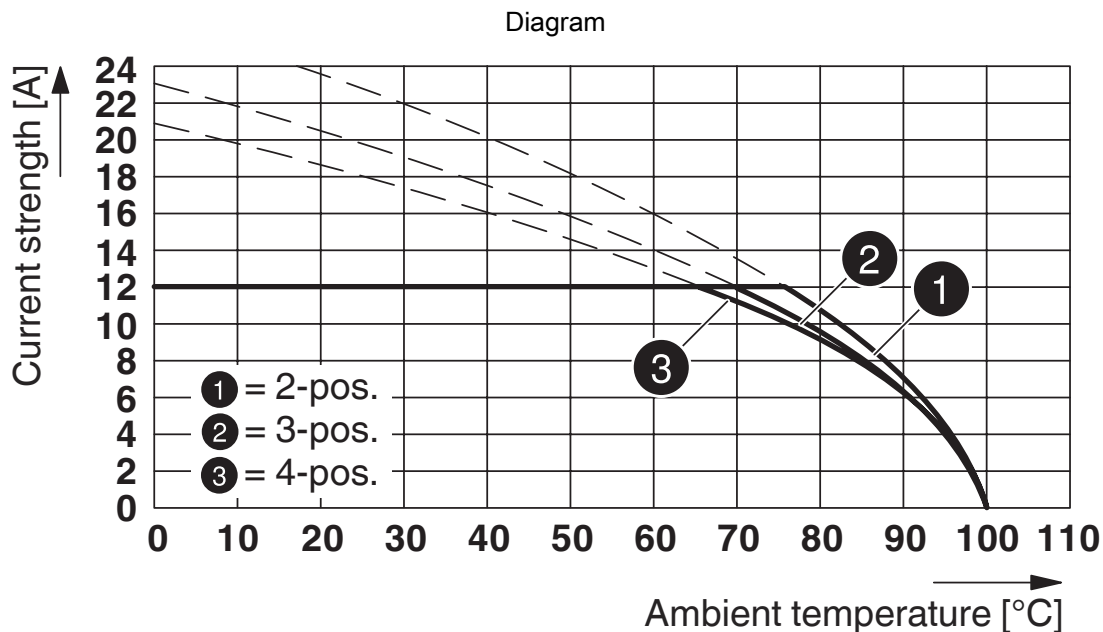

Type: MSTB 2,5/...-ST with MSTBO 2,5/...-G1L

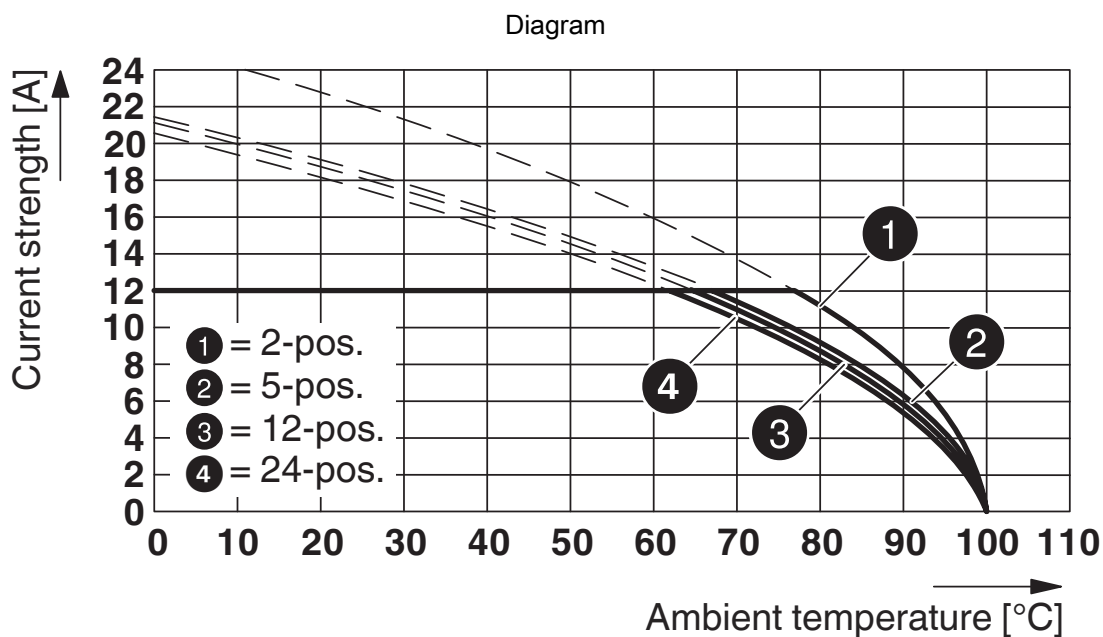

Type: MSTB 2,5/...-ST with MSTBA 2,5/...-G

1754449

<https://www.phoenixcontact.com/de/produkte/1754449>

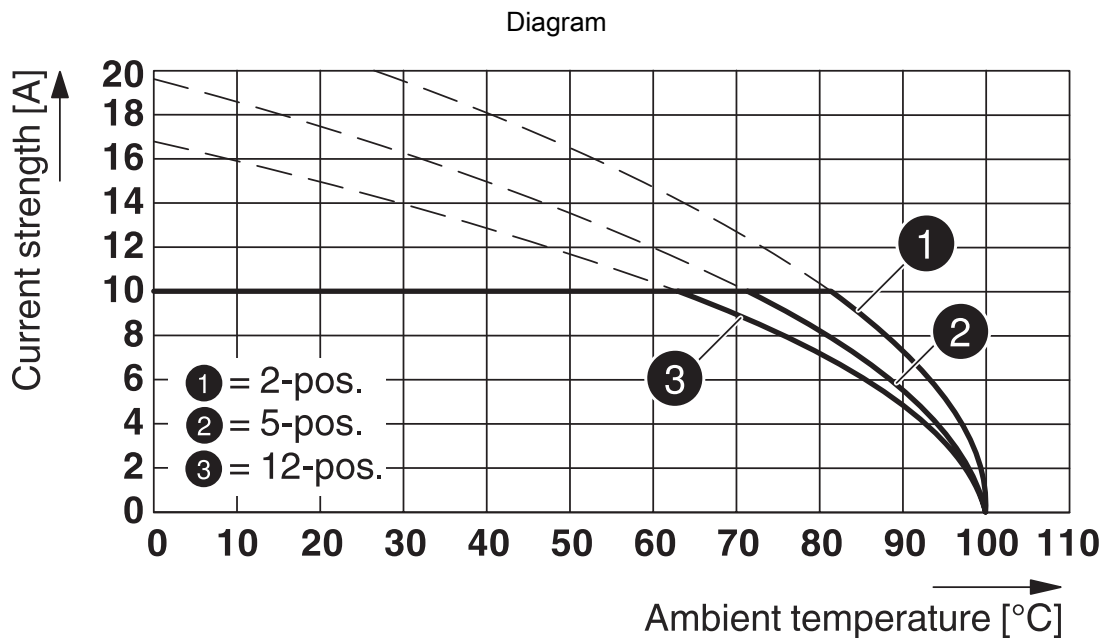

Type: MSTB 2,5/...-ST with MDSTBW 2,5/...-G

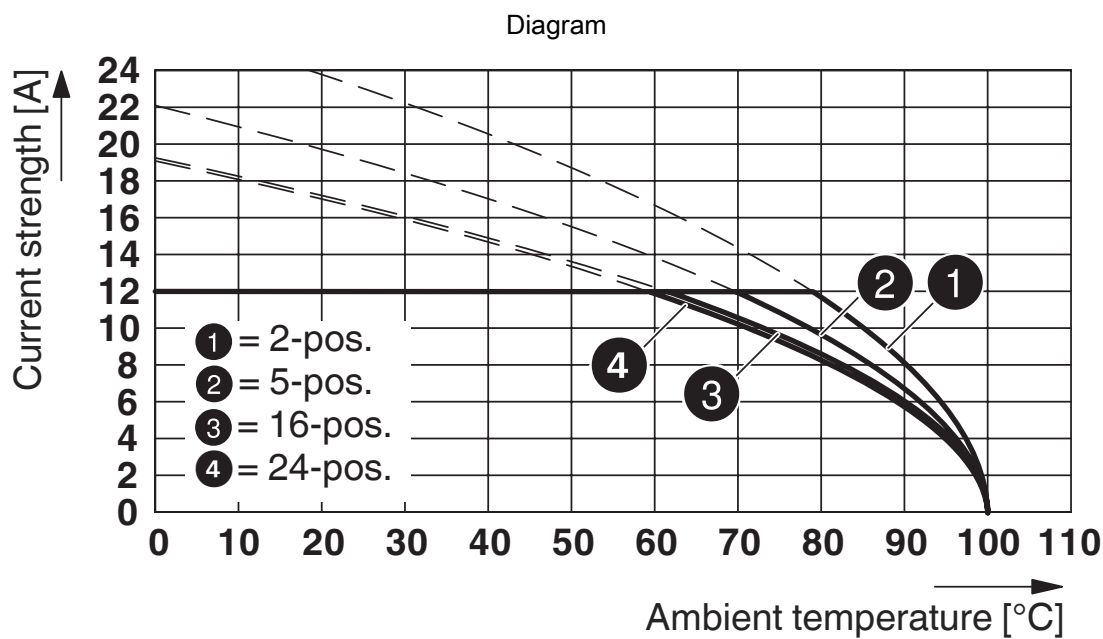

Type: MSTB 2,5/...-ST with SMSTBA 2,5/...-G

1754449

<https://www.phoenixcontact.com/de/produkte/1754449>

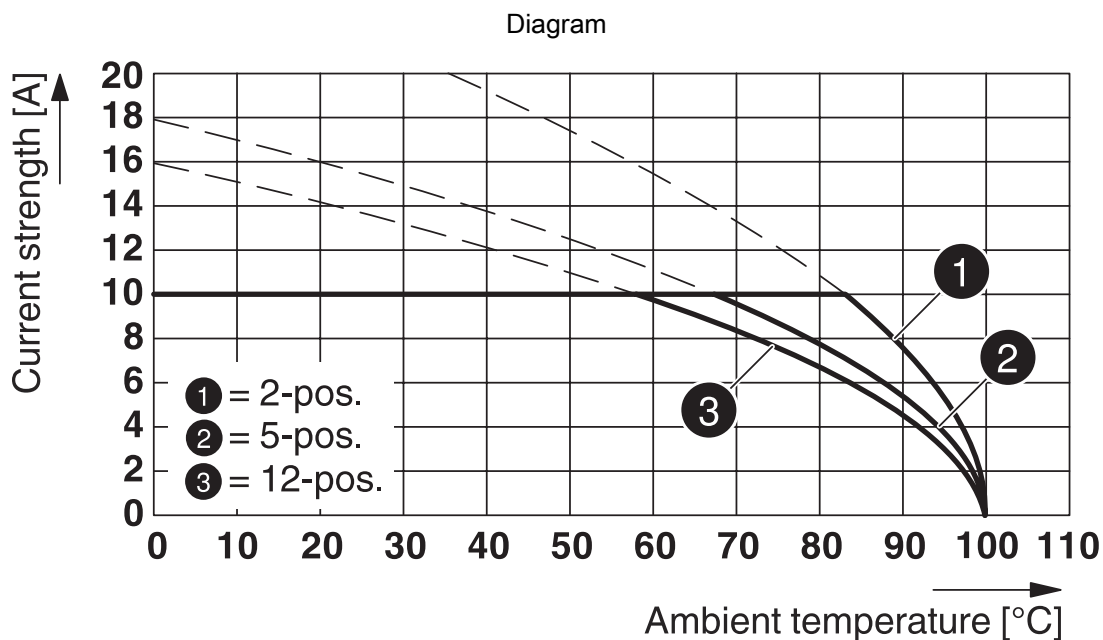

Type: MSTB 2,5/...-ST with MDSTB 2,5/...-G

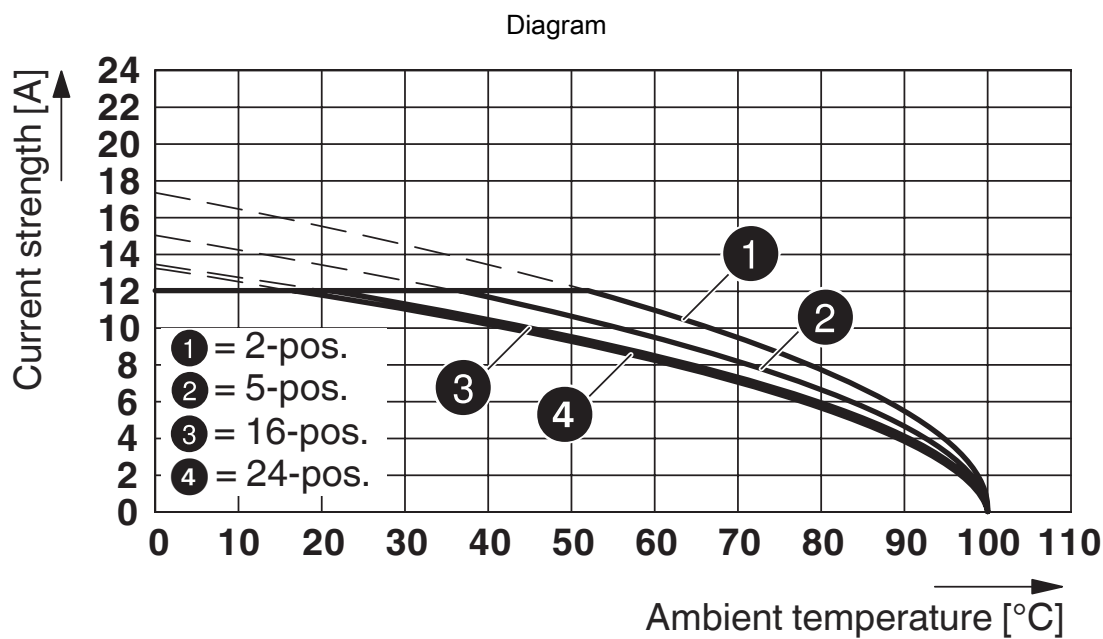

Type: MSTB 2,5/...-ST with MSTBVA 2,5/...-G

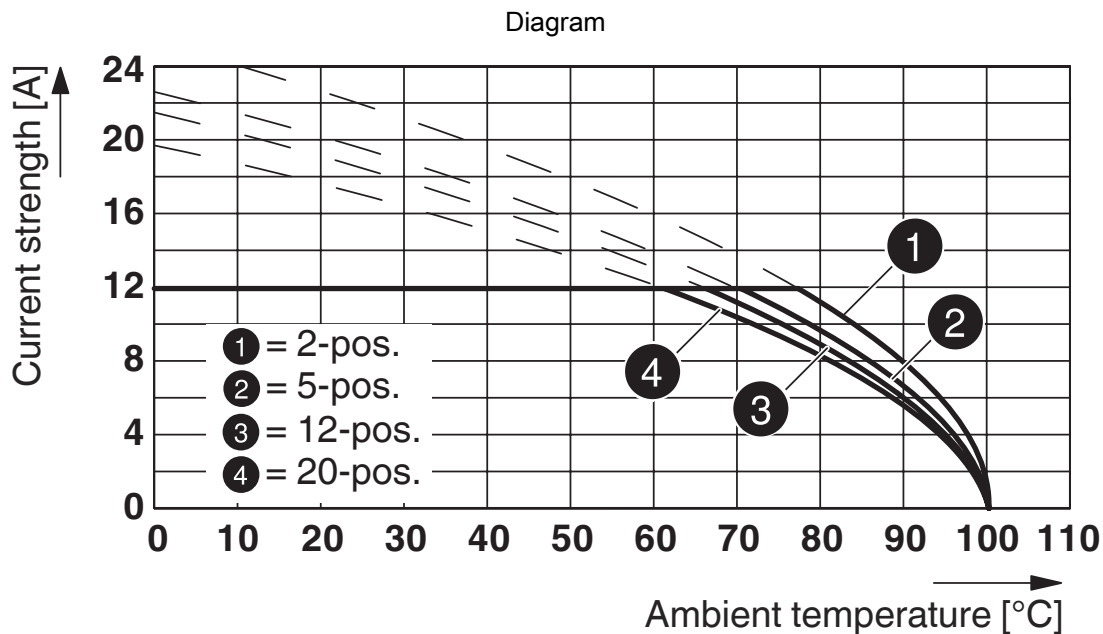

Type: MSTB 2,5/...-ST with MSTBW 2,5/...-G

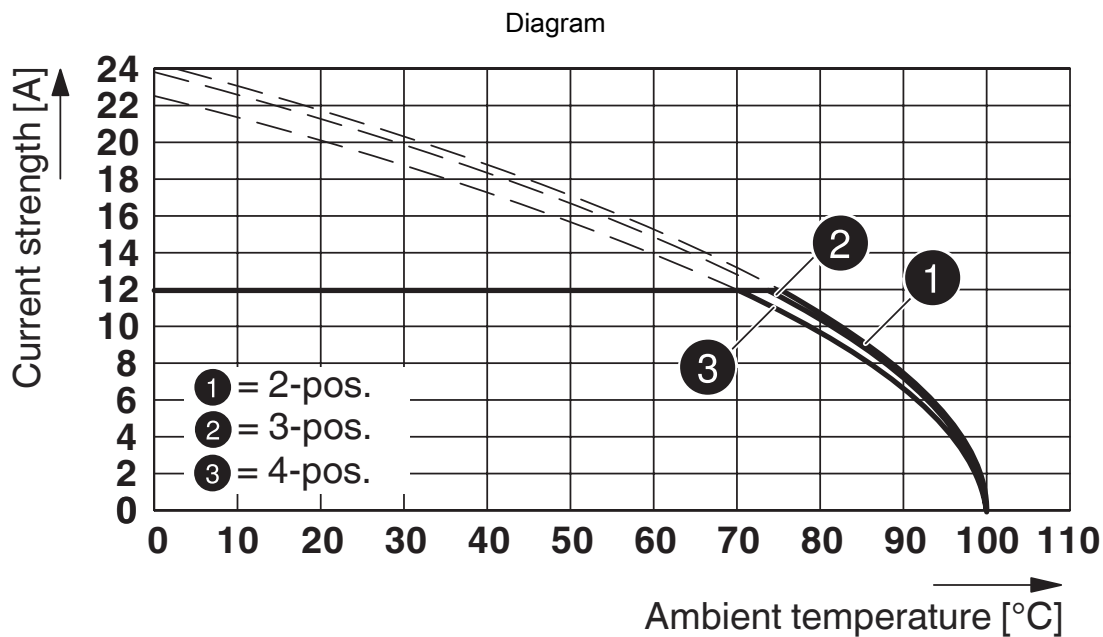

Type: MSTB 2,5/...-ST with MSTBO 2,5/...-G1R

1754449

<https://www.phoenixcontact.com/de/produkte/1754449>

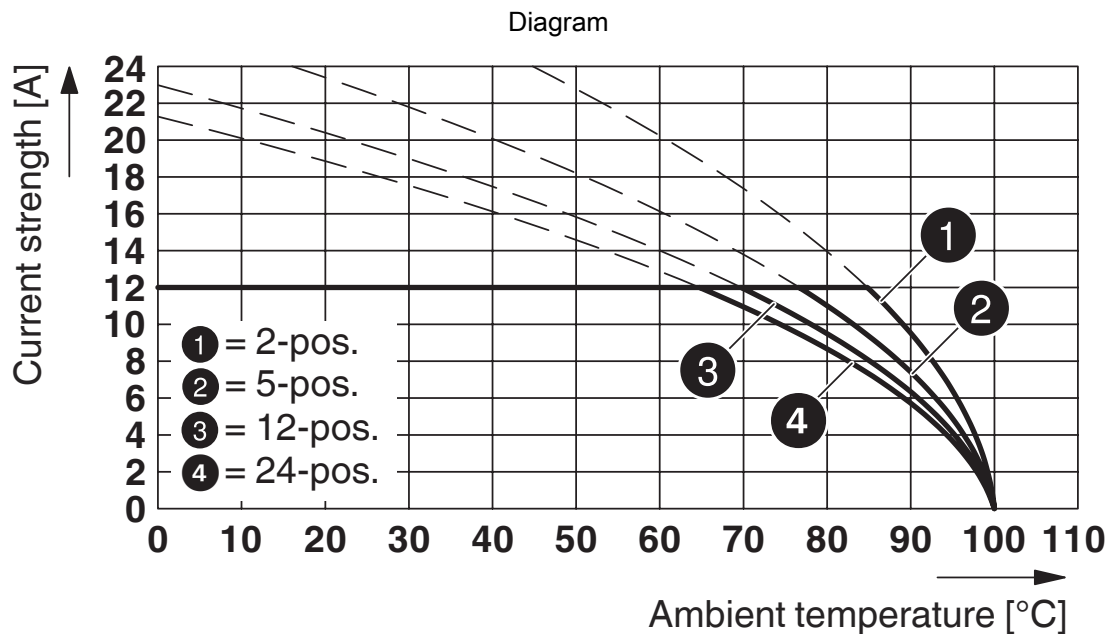

Type: MSTB 2,5/...-ST with CCA 2,5/...-G P20 THR

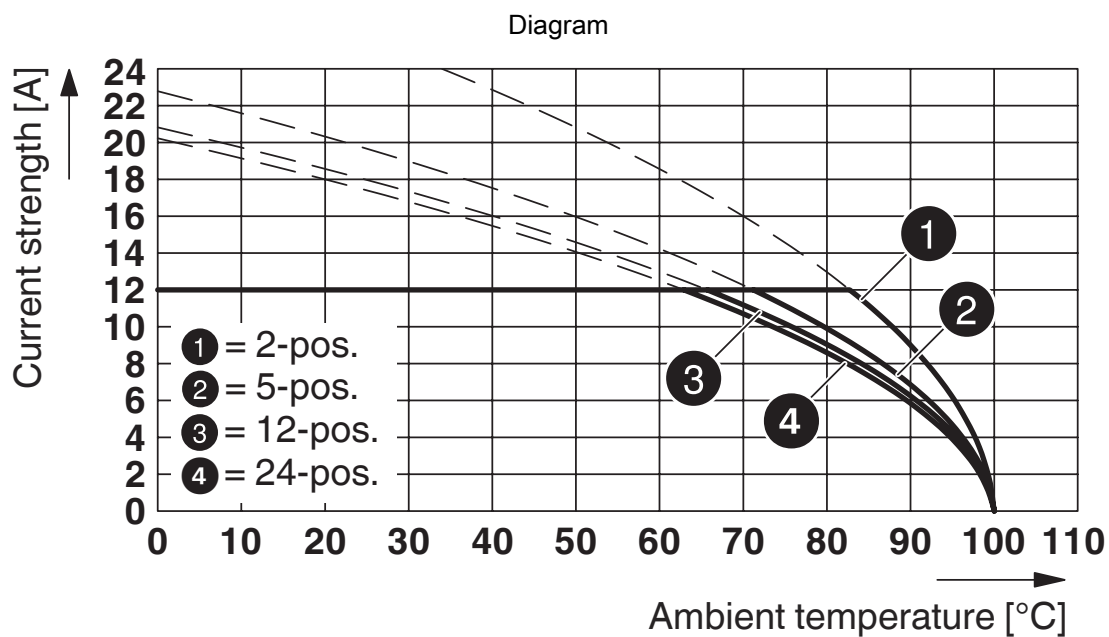

Type: MSTB 2,5/...-ST with CCVA 2,5/...-G P20 THR

1754449

<https://www.phoenixcontact.com/de/produkte/1754449>

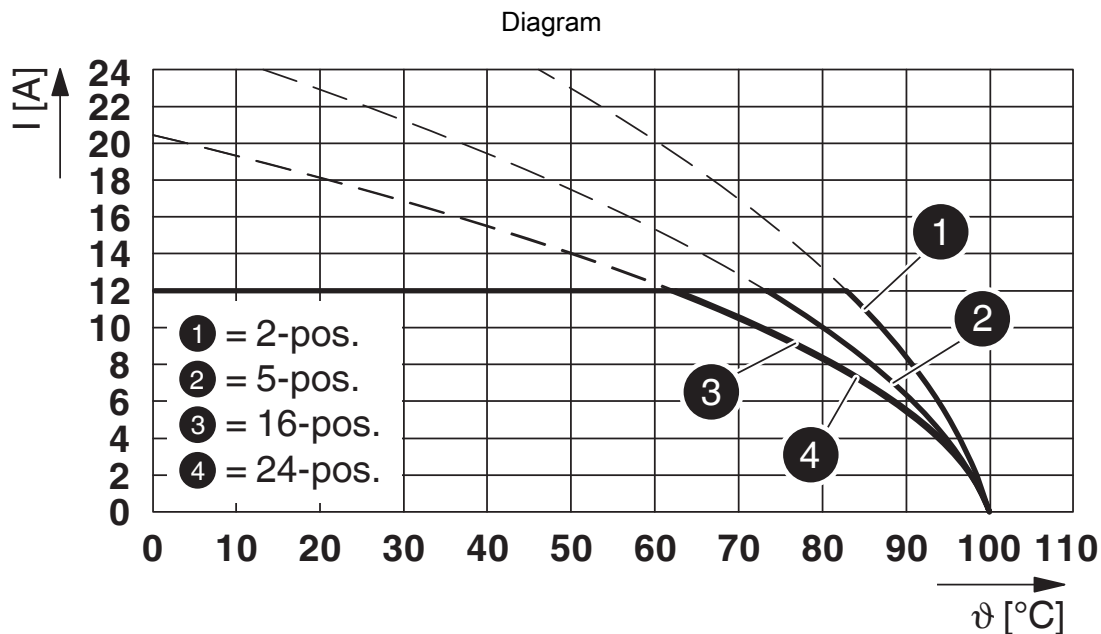

Type: MSTB 2,5/...-ST with MSTB 2,5/...-G

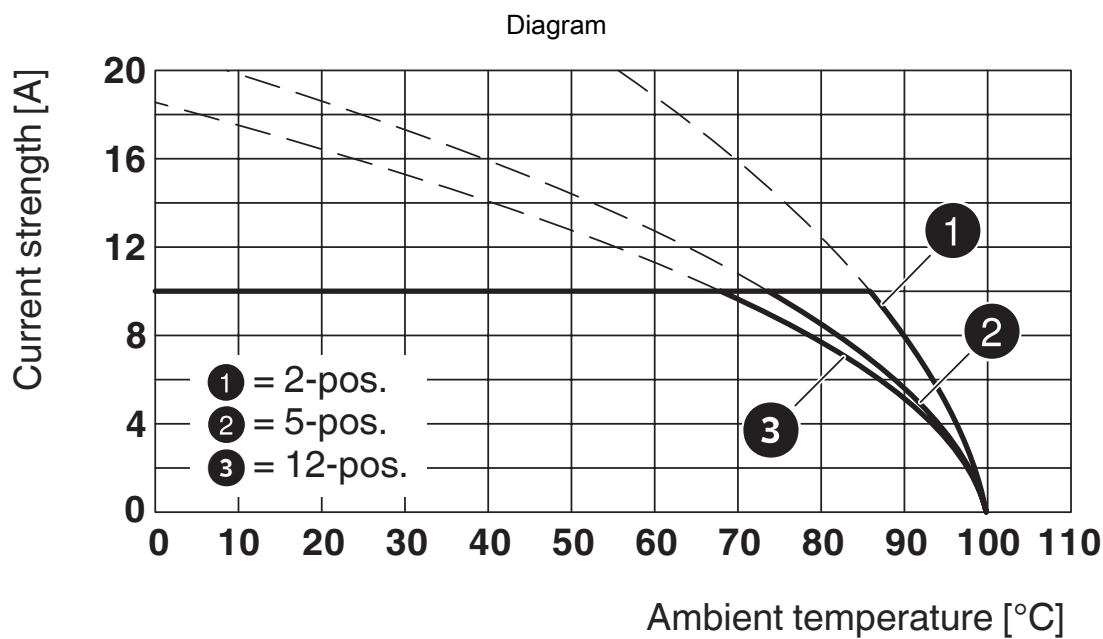

Type: MSTB 2,5/...-ST with MDSTBV 2,5/...-G

PCB connector - MSTB 2,5/ 2-ST



1754449

<https://www.phoenixcontact.com/de/produkte/1754449>

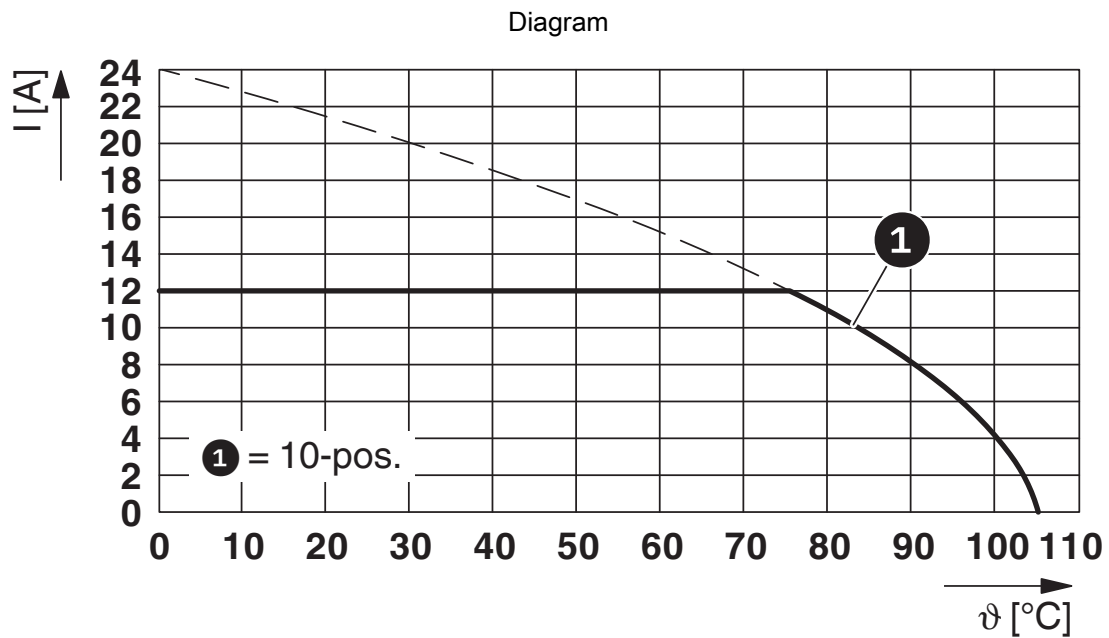

Type: MSTB 2,5/...-ST with MSTBHK 2,5/...-G

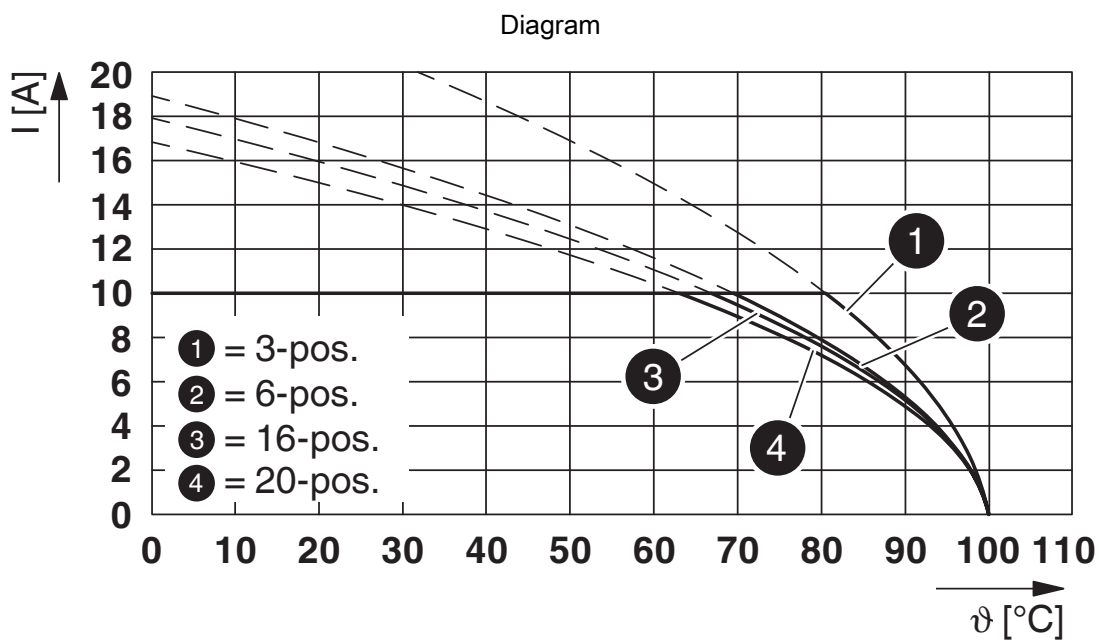

Type: MSTB 2,5/...-ST with MDSTB 2,5/...-G1

PCB connector - MSTB 2,5/ 2-ST



1754449

<https://www.phoenixcontact.com/de/produkte/1754449>

Approvals

 CSA Approval ID: LR13631-2585950				
	Nominal Voltage U_N	Nominal Current I_N	Cross Section AWG	Cross Section mm^2
Use group B	300 V	15 A	28 - 12	-
Use group D	300 V	10 A	28 - 12	-

 IECEE CB Scheme Approval ID: DE1-60988-B1B2				
	Nominal Voltage U_N	Nominal Current I_N	Cross Section AWG	Cross Section mm^2
	250 V	12 A	-	0.2 - 2.5

 EAC Approval ID: B.01687				
--	--	--	--	--

 cULus Recognized Approval ID: E60425-19931011				
	Nominal Voltage U_N	Nominal Current I_N	Cross Section AWG	Cross Section mm^2
Use group B	300 V	15 A	30 - 12	-
Use group D	300 V	10 A	30 - 12	-

 VDE Zeichengenehmigung Approval ID: 40004701				
	Nominal Voltage U_N	Nominal Current I_N	Cross Section AWG	Cross Section mm^2
	250 V	12 A	-	0.2 - 2.5

PCB connector - MSTB 2,5/ 2-ST



1754449

<https://www.phoenixcontact.com/de/produkte/1754449>

Classifications

ECLASS

ECLASS-9.0	27440309
ECLASS-10.0.1	27440309
ECLASS-11.0	27460202

ETIM

ETIM 8.0	EC002638
----------	----------

UNSPSC

UNSPSC 21.0	39121400
-------------	----------

PCB connector - MSTB 2,5/ 2-ST



1754449

<https://www.phoenixcontact.com/de/produkte/1754449>

Environmental Product Compliance

REACH SVHC	Lead 7439-92-1
China RoHS	Environmentally Friendly Use Period = 50 years
	For information on hazardous substances, refer to the manufacturer's declaration available under "Downloads"

PCB connector - MSTB 2,5/ 2-ST

1754449

<https://www.phoenixcontact.com/de/produkte/1754449>

Accessories

Screwdriver

Screwdriver - SZS 0,6X3,5 - 1205053

<https://www.phoenixcontact.com/de/produkte/1205053>



Actuation tool, for ST terminal blocks, insulated, also suitable for use as a bladed screwdriver, size: 0.6 x 3.5 x 100 mm, 2-component grip, with non-slip grip

Marker card

Marker card - SK 5/3,8:FORTL.ZAHLEN - 0804183

<https://www.phoenixcontact.com/de/produkte/0804183>

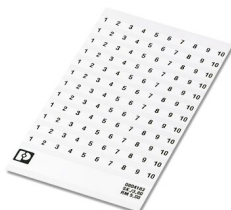

Marker card, white, labeled, horizontal: consecutive numbers 1 ... 10, 11 ... 20, etc. up to 91 ... (99)100, mounting type: adhesive, for terminal block width: 5 mm, lettering field size: 5 x 3.8 mm

PCB connector - MSTB 2,5/ 2-ST

1754449

<https://www.phoenixcontact.com/de/produkte/1754449>

Cable housing

Cable housing - KGG-MSTB 2,5/ 2 - 1803934

<https://www.phoenixcontact.com/de/produkte/1803934>

Cable housing, pitch: 0 mm, number of positions: 2, color: green

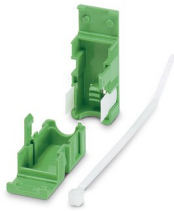

Coding profile

Coding profile - CP-MSTB - 1734634

<https://www.phoenixcontact.com/de/produkte/1734634>

Coding profile, is inserted into the slot on the plug or inverted header, red insulating material



PCB connector - MSTB 2,5/ 2-ST

1754449

<https://www.phoenixcontact.com/de/produkte/1754449>



Insertion bridge

Insertion bridge - EBP 2- 5 - 1733169

<https://www.phoenixcontact.com/de/produkte/1733169>

Insertion bridge for connectors with 5.0 mm or 5.08 mm pitch



Marker card

Marker card - SK 5/3,8:UNBEDRUCKT - 0805409

<https://www.phoenixcontact.com/de/produkte/0805409>

Marker card, white, unlabeled, can be labeled with: Marker pen, mounting type: adhesive, for terminal block width: 5 mm, lettering field size: 5 x 3.8 mm



PCB connector - MSTB 2,5/ 2-ST

1754449

<https://www.phoenixcontact.com/de/produkte/1754449>

Marker pen

Marker pen - B-STIFT - 1051993

<https://www.phoenixcontact.com/de/produkte/1051993>



Marker pen, for manual labeling of unprinted Zack strips, smear-proof and waterproof, line thickness 0.5 mm

PCB header

PCB header - MSTBW 2,5/ 2-G - 1736111

<https://www.phoenixcontact.com/de/produkte/1736111>

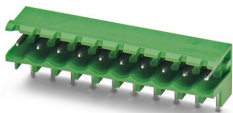

PCB headers, nominal cross section: 2.5 mm², color: green, nominal current: 12 A, rated voltage (III/2): 320 V, contact surface: Tin, type of contact: Male connector, number of potentials: 2, number of rows: 1, number of positions: 2, number of connections: 2, product range: MSTBW 2,5/...-G, pitch: 5 mm, pin layout: Linear pinning, solder pin [P]: 3.5 mm, number of solder pins per potential: 1, plug-in system: COMBICON MSTB 2,5, Pin connector pattern alignment: Standard, locking: without, mounting: without, type of packaging: packed in cardboard

PCB connector - MSTB 2,5/ 2-ST

1754449

<https://www.phoenixcontact.com/de/produkte/1754449>

PCB header

PCB header - MSTBV 2,5/ 2-G - 1753437

<https://www.phoenixcontact.com/de/produkte/1753437>

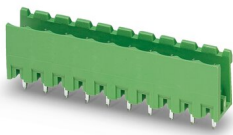

PCB headers, nominal cross section: 2.5 mm², color: green, nominal current: 12 A, rated voltage (III/2): 320 V, contact surface: Tin, type of contact: Male connector, number of potentials: 2, number of rows: 2, number of positions: 2, number of connections: 2, product range: MSTBV 2,5/...-G, pitch: 5 mm, pin layout: Linear pinning, solder pin [P]: 3.9 mm, number of solder pins per potential: 1, plug-in system: COMBICON MSTB 2,5, Pin connector pattern alignment: Standard, locking: without, mounting: without, type of packaging: packed in cardboard

PCB header

PCB header - SMSTB 2,5/ 2-G - 1769230

<https://www.phoenixcontact.com/de/produkte/1769230>



PCB headers, nominal cross section: 2.5 mm², color: green, nominal current: 12 A, rated voltage (III/2): 320 V, contact surface: Tin, type of contact: Male connector, number of potentials: 2, number of rows: 1, number of positions: 2, number of connections: 2, product range: SMSTB 2,5/...-G, pitch: 5 mm, pin layout: Linear pinning, solder pin [P]: 3.5 mm, number of solder pins per potential: 1, plug-in system: COMBICON MSTB 2,5, Pin connector pattern alignment: Standard, locking: without, mounting: without, type of packaging: packed in cardboard

PCB connector - MSTB 2,5/ 2-ST

1754449

<https://www.phoenixcontact.com/de/produkte/1754449>

PCB header

PCB header - SMSTBA 2,5/ 2-G - 1769803

<https://www.phoenixcontact.com/de/produkte/1769803>



PCB headers, nominal cross section: 2.5 mm², color: green, nominal current: 12 A, rated voltage (III/2): 320 V, contact surface: Tin, type of contact: Male connector, number of potentials: 2, number of rows: 1, number of positions: 2, number of connections: 2, product range: SMSTBA 2,5/...-G, pitch: 5 mm, pin layout: Linear pinning, solder pin [P]: 3.5 mm, number of solder pins per potential: 1, plug-in system: COMBICON MSTB 2,5, Pin connector pattern alignment: Standard, locking: without, mounting: without, type of packaging: packed in cardboard

PCB header

PCB header - MDSTBVA 2,5/ 2-G - 1845785

<https://www.phoenixcontact.com/de/produkte/1845785>

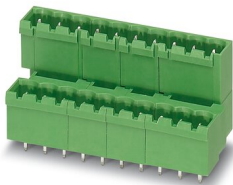

PCB headers, nominal cross section: 2.5 mm², color: green, nominal current: 10 A, rated voltage (III/2): 320 V, contact surface: Tin, type of contact: Male connector, number of potentials: 4, number of rows: 2, number of positions: 2, number of connections: 4, product range: MDSTBVA 2,5/...-G, pitch: 5 mm, pin layout: Linear pinning, solder pin [P]: 3.9 mm, number of solder pins per potential: 1, plug-in system: COMBICON MSTB 2,5, Pin connector pattern alignment: Standard, locking: without, mounting: without, type of packaging: packed in cardboard, The article can be aligned to create different nos. of positions! In combination with MVSTB or FKCV plug components, both an MVSTBW (or FKCVW) and an MVSTBR plug (or FKCVR) must be used. Combination with TMSTBP plug components is not possible!

PCB connector - MSTB 2,5/ 2-ST

1754449

<https://www.phoenixcontact.com/de/produkte/1754449>

PCB header

PCB header - MDSTBA 2,5/ 2-G - 1846519

<https://www.phoenixcontact.com/de/produkte/1846519>

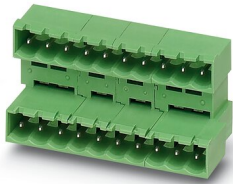

PCB headers, nominal cross section: 2.5 mm², color: green, nominal current: 10 A, rated voltage (III/2): 320 V, contact surface: Tin, type of contact: Male connector, number of potentials: 4, number of rows: 2, number of positions: 2, number of connections: 4, product range: MDSTBA 2,5/..-G, pitch: 5 mm, pin layout: Linear pinning, solder pin [P]: 3.2 mm, number of solder pins per potential: 1, plug-in system: COMBICON MSTB 2,5, Pin connector pattern alignment: Standard, locking: without, mounting: without, type of packaging: packed in cardboard, The article can be aligned to create different nos. of positions! In combination with MVSTB or FKCV plug components, both an MVSTBW (or FKCVW) and an MVSTBR plug (or FKCVR) must be used. Combination with TMSTBP plug components is not possible!

PCB header

PCB header - MSTBO 2,5/ 2-G1R - 1861044

<https://www.phoenixcontact.com/de/produkte/1861044>



PCB headers, nominal cross section: 2.5 mm², color: green, nominal current: 12 A, rated voltage (III/2): 320 V, type of contact: Male connector, number of potentials: 2, number of rows: 1, number of positions: 2, number of connections: 2, product range: MSTBO 2,5/..-G1R, pitch: 5 mm, pin layout: Linear pinning, solder pin [P]: 3.5 mm, number of solder pins per potential: 1, locking: without, type of packaging: packed in cardboard, Product with pin output on right side

PCB connector - MSTB 2,5/ 2-ST

1754449

<https://www.phoenixcontact.com/de/produkte/1754449>

PCB header

PCB header - MSTBO 2,5/ 2-G1L - 1861057

<https://www.phoenixcontact.com/de/produkte/1861057>



PCB headers, nominal cross section: 2.5 mm², color: green, nominal current: 12 A, rated voltage (III/2): 320 V, contact surface: Tin, type of contact: Male connector, number of potentials: 2, number of rows: 1, number of positions: 2, number of connections: 2, product range: MSTBO 2,5/...-G1L, pitch: 5 mm, pin layout: Linear pinning, solder pin [P]: 3.5 mm, number of solder pins per potential: 1, locking: without, type of packaging: packed in cardboard, Product with pin output on left side

PCB header

PCB header - MDSTBVA 2,5/ 2-GL - 1877724

<https://www.phoenixcontact.com/de/produkte/1877724>

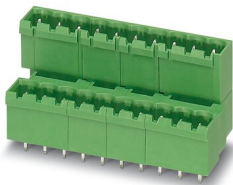

PCB headers, nominal cross section: 2.5 mm², color: green, nominal current: 10 A, rated voltage (III/2): 320 V, contact surface: Tin, type of contact: Male connector, number of potentials: 4, number of rows: 2, number of positions: 2, number of connections: 4, product range: MDSTBVA 2,5/...-G, pitch: 5 mm, pin layout: Linear pinning, solder pin [P]: 3.9 mm, number of solder pins per potential: 1, plug-in system: COMBICON MSTB 2,5, Pin connector pattern alignment: Standard, locking: without, mounting: without, type of packaging: packed in cardboard, The article can be aligned to create different nos. of positions! In combination with MVSTB or FKCV plug components, both an MVSTBW (or FKCVW) and an MVSTBR plug (or FKCVR) must be used. Combination with TMSTBP plug components is not possible!

PCB connector - MSTB 2,5/ 2-ST

1754449

<https://www.phoenixcontact.com/de/produkte/1754449>

PCB header

PCB header - MDSTBVA 2,5/ 2-GR - 1877737

<https://www.phoenixcontact.com/de/produkte/1877737>

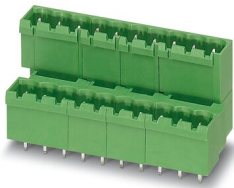

PCB headers, nominal cross section: 2.5 mm², color: green, nominal current: 10 A, rated voltage (III/2): 320 V, contact surface: Tin, type of contact: Male connector, number of potentials: 4, number of rows: 2, number of positions: 2, number of connections: 4, product range: MDSTBVA 2,5/...-G, pitch: 5 mm, pin layout: Linear pinning, solder pin [P]: 3.9 mm, number of solder pins per potential: 1, plug-in system: COMBICON MSTB 2,5, Pin connector pattern alignment: Standard, locking: without, mounting: without, type of packaging: packed in cardboard, The article can be aligned to create different nos. of positions! In combination with MVSTB or FKCV plug components, both an MVSTBW (or FKCVW) and an MVSTBR plug (or FKCVR) must be used. Combination with TMSTBP plug components is not possible!

PCB header

PCB header - MSTBO 2,5/ 2-G1L THRR32 BK - 2200251

<https://www.phoenixcontact.com/de/produkte/2200251>



PCB headers, nominal cross section: 2.5 mm², color: black, nominal current: 16 A, rated voltage (III/2): 320 V, contact surface: Tin, type of contact: Male connector, number of potentials: 2, number of rows: 1, number of positions: 2, number of connections: 2, product range: MSTBO 2,5/...-G1L-THR, pitch: 5 mm, pin layout: Linear pinning, solder pin [P]: 2.5 mm, number of solder pins per potential: 1, plug-in system: COMBICON MSTB 2,5, locking: without, type of packaging: 32 mm wide tape, Product with pin output on left side

PCB connector - MSTB 2,5/ 2-ST

1754449

<https://www.phoenixcontact.com/de/produkte/1754449>

PCB header

PCB header - MSTBO 2,5/ 2-G1R THRR32 BK - 2200252

<https://www.phoenixcontact.com/de/produkte/2200252>



PCB headers, nominal cross section: 2.5 mm², color: black, nominal current: 16 A, rated voltage (III/2): 320 V, contact surface: Tin, type of contact: Male connector, number of potentials: 2, number of rows: 1, number of positions: 2, number of connections: 2, product range: MSTBO 2,5/..-G1R-THR, pitch: 5 mm, pin layout: Linear pinning, solder pin [P]: 2.5 mm, number of solder pins per potential: 1, plug-in system: COMBICON MSTB 2,5, locking: without, type of packaging: 32 mm wide tape, Product with pin output on left side

PCB header

PCB header - MSTBO 2,5/ 2-G1L KMGY - 2854788

<https://www.phoenixcontact.com/de/produkte/2854788>



PCB headers, nominal cross section: 2.5 mm², color: light grey, nominal current: 12 A, rated voltage (III/2): 320 V, contact surface: Tin, type of contact: Male connector, number of potentials: 2, number of rows: 1, number of positions: 2, number of connections: 2, product range: MSTBO 2,5/..-G1L, pitch: 5 mm, pin layout: Linear pinning, solder pin [P]: 3.5 mm, number of solder pins per potential: 1, locking: without, type of packaging: packed in cardboard, Product with pin output on left side

PCB connector - MSTB 2,5/ 2-ST



1754449

<https://www.phoenixcontact.com/de/produkte/1754449>

PCB header

PCB header - MSTBO 2,5/ 2-G1R KMGY - 2854791

<https://www.phoenixcontact.com/de/produkte/2854791>



PCB headers, nominal cross section: 2.5 mm², color: light grey, nominal current: 12 A, rated voltage (III/2): 320 V, contact surface: Tin, type of contact: Male connector, number of potentials: 2, number of rows: 1, number of positions: 2, number of connections: 2, product range: MSTBO 2,5/..-G1R, pitch: 5 mm, pin layout: Linear pinning, solder pin [P]: 3.5 mm, number of solder pins per potential: 1, locking: without, type of packaging: packed in cardboard, Product with pin output on right side

Phoenix Contact 2022 © - all rights reserved

<https://www.phoenixcontact.com>

PHOENIX CONTACT Deutschland GmbH

Flachsmarktstraße 8

D-32825 Blomberg

+49 52 35/3-1 20 00

info@phoenixcontact.de