

Data connector - SACC-M12MSD-4CON-PG 9-SH



1521261

<https://www.phoenixcontact.com/pc/products/1521261>

Please be informed that the data shown in this PDF document is generated from our Online Catalog. Please find the complete data in the user documentation. Our General Terms of Use for Downloads are valid.



Data connector, Ethernet/PROFINET CAT5 (100 Mbps), 4-position, shielded, Plug straight M12, Coding: D, Screw connection, knurl material: Zinc die-cast, nickel-plated, cable gland Pg9, external cable diameter 6 mm ... 8 mm

Your advantages

- Safe use in the field, thanks to a high degree of protection
- Screw connection: proven connection technology for a large selection of different conductors
- Reliable signal transmission - 360° shielding in environments with electromagnetic interference

Data connector - SACC-M12MSD-4CON-PG 9-SH



1521261

<https://www.phoenixcontact.com/pc/products/1521261>

Commercial Data

| | |
|--------------------------------------|---------------------|
| Item number | 1521261 |
| Packing unit | 1 pc |
| Minimum order quantity | 1 pc |
| Product Key | BF2CBI |
| Catalog Page | Page 236 (C-4-2013) |
| GTIN | 4017918968618 |
| Weight per Piece (including packing) | 44.02 g |
| Weight per Piece (excluding packing) | 44.02 g |
| Customs tariff number | 85366990 |
| Country of origin | DE |

Technical Data

Notes

| | |
|-----------------------|--|
| General | This product corresponds to the PROFINET Cabling and Interconnection Technology Guideline for PROFINET regulations, version 2.00, order no: 2.252, Chapter 8.2 Connectors for Outside Environment (Balanced cabling) |
| Assembly instruction: | NOTE: Observe the permissible bending radii when laying conductors, since the degree of protection may be put in jeopardy if the bending forces are too high. Alleviate mechanical loads upstream of the connector, e.g. by using cable ties. |

Product properties

| | |
|----------------------|---------------------------------|
| Product type | Circular connector (cable-side) |
| Number of positions | 4 |
| No. of cable outlets | 1 |
| Shielded | yes |
| Coding | D - data |
| Cable outlet | straight |
| Pg screw connection | Pg9 |

Insulation characteristics

| | |
|----------------------|----|
| Overvoltage category | II |
| Degree of pollution | 3 |

Ambient conditions

| | |
|---------------------------------|----------------------------------|
| Degree of protection | IP67 |
| Ambient temperature (operation) | -40 °C ... 85 °C (Plug / socket) |

Dimensions

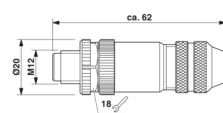
| | |
|---------------------|--|
| Dimensional drawing |  |
| Length | 62 mm |

External dimensions

| | |
|------------------|---------------|
| Outside diameter | 6 mm ... 8 mm |
|------------------|---------------|

Housing

| | |
|------------------|-------|
| Diameter housing | 20 mm |
|------------------|-------|

Connector

| | |
|-----------------------------|-------|
| Insertion/withdrawal cycles | ≥ 100 |
|-----------------------------|-------|

Header 1

Data connector - SACC-M12MSD-4CON-PG 9-SH



1521261

<https://www.phoenixcontact.com/pc/products/1521261>

| | |
|-----------------------------|------------------|
| Head design | Plug |
| Head cable outlet | straight |
| Head thread type | M12 |
| Coding | D-coded |
| Number of positions | 4 |
| Coding | D - data |
| Insertion/withdrawal cycles | ≥ 100 |
| Connection method | Screw connection |
| Contact material | CuZn |
| Contact surface material | Au |
| Number of positions | 4 |
| Coding | D - data |
| Insertion/withdrawal cycles | ≥ 100 |
| Connection method | Screw connection |
| Contact material | CuZn |
| Contact surface material | Au |

Electrical properties

| | |
|-----------------------|----------|
| Rated surge voltage | 2.5 kV |
| Contact resistance | ≤ 3 mΩ |
| Insulation resistance | ≥ 100 MΩ |
| Nominal voltage U_N | 48 V AC |
| | 60 V DC |
| Nominal current I_N | 4 A |

Material specifications

| | |
|--|------------------------------|
| Flammability rating according to UL 94 | HB |
| Sealing material | NBR |
| Material of grip body | Zinc die-cast, nickel-plated |
| Contact material | CuZn |
| Contact surface material | Au |
| Contact carrier material | PA |
| Cable gland material | Zinc die-cast, nickel-plated |

Connection data

Conductor connection

| | |
|----------------------------------|---|
| Connection method | Screw connection |
| Conductor cross section flexible | 0.25 mm ² ... 0.75 mm ² |
| Cross section AWG | 24 ... 18 |

Standards and regulations

| | |
|--------------------------|-----------------|
| Standards/specifications | IEC 61076-2-101 |
|--------------------------|-----------------|

Cable / line

Data connector - SACC-M12MSD-4CON-PG 9-SH



1521261

<https://www.phoenixcontact.com/pc/products/1521261>

Cable structure

| | |
|---|--|
| Signal type/category | Ethernet/PROFINET CAT5 (on the basis of IEC 11801), 100 Mbps |
| Stripping length of the individual wire | 5 mm |

Drawings

Schematic diagram

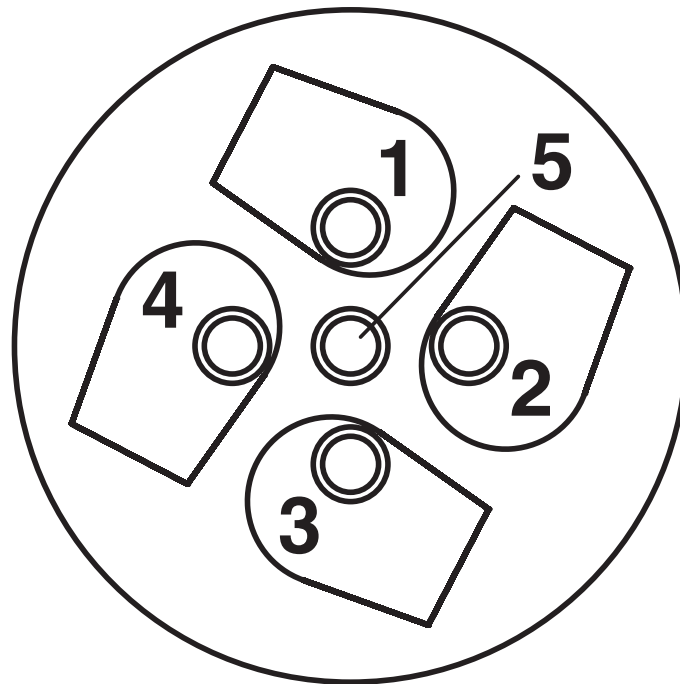

Cable connection side M12 (screw connection)

Schematic diagram

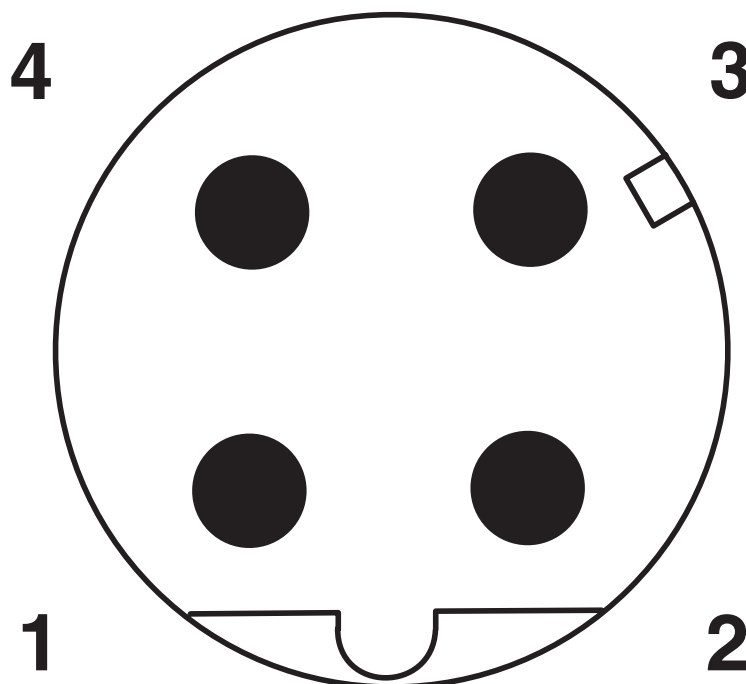

Pin assignment M12 male connector, 4-pos., D-coded, male side

1521261

<https://www.phoenixcontact.com/pc/products/1521261>

Functional drawing

Assembly steps for M 12 male/female connector and conductor

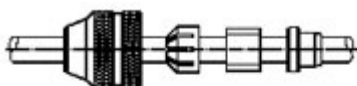

Slide parts onto the conductor

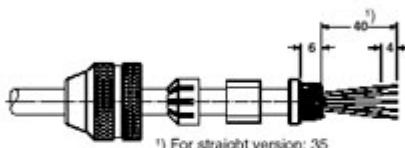

Strip conductor, widen shield and lay around the shielding ring, cut off projecting mesh.

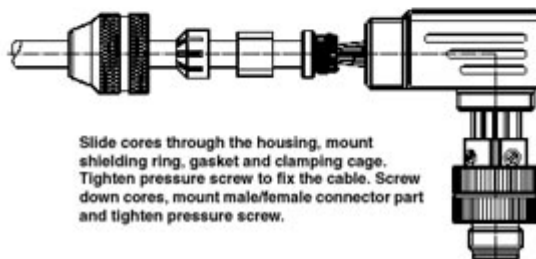

Slide cores through the housing, mount shielding ring, gasket and clamping cage. Tighten pressure screw to fix the cable. Screw down cores, mount male/female connector part and tighten pressure screw.

Dimensional drawing

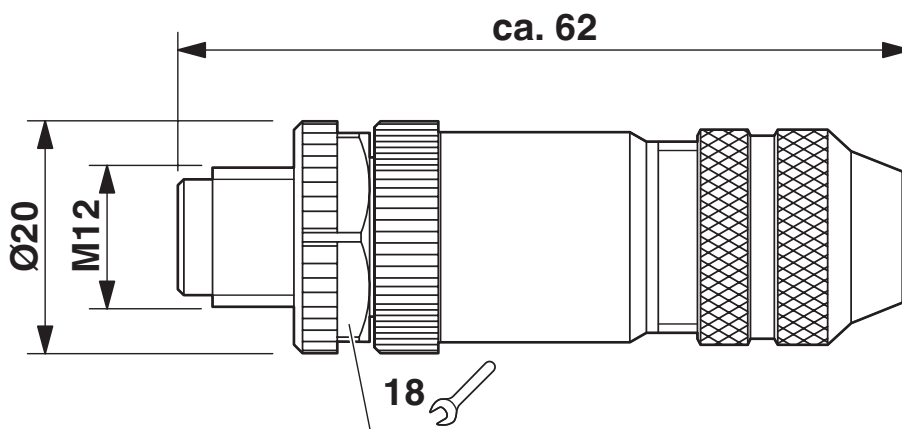

Plug, M12 x 1, straight, shielded

Data connector - SACC-M12MSD-4CON-PG 9-SH



1521261

<https://www.phoenixcontact.com/pc/products/1521261>

Approvals

|  cUL Recognized Approval ID: FILE E 221474 | | | | |
|---|-----------------------|-----------------------|-------------------|-----------------------------|
| | Nominal Voltage U_N | Nominal Current I_N | Cross Section AWG | Cross Section mm^2 |
| | 250 V | 4 A | - | - |

|  UL Recognized Approval ID: FILE E 221474 | | | | |
|--|-----------------------|-----------------------|-------------------|-----------------------------|
| | Nominal Voltage U_N | Nominal Current I_N | Cross Section AWG | Cross Section mm^2 |
| | 250 V | 4 A | - | - |

cULus Recognized

1521261

<https://www.phoenixcontact.com/pc/products/1521261>

Classifications

ECLASS

| | |
|---------------|----------|
| ECLASS-10.0.1 | 27440102 |
| ECLASS-9.0 | 27440102 |
| ECLASS-11.0 | 27440102 |

ETIM

| | |
|----------|----------|
| ETIM 8.0 | EC002635 |
|----------|----------|

UNSPSC

| | |
|-------------|----------|
| UNSPSC 21.0 | 39121400 |
|-------------|----------|

Data connector - SACC-M12MSD-4CON-PG 9-SH



1521261

<https://www.phoenixcontact.com/pc/products/1521261>

Environmental Product Compliance

| | |
|------------|--|
| REACH SVHC | Lead 7439-92-1 |
| China RoHS | Environmentally Friendly Use Period = 50 years |
| | For information on hazardous substances, refer to the manufacturer's declaration available under "Downloads" |

Data connector - SACC-M12MSD-4CON-PG 9-SH



1521261

<https://www.phoenixcontact.com/pc/products/1521261>

Accessories

Screwdriver

Screwdriver - SZF 1-0,6X3,5 - 1204517

<https://www.phoenixcontact.com/pc/products/1204517>



Actuation tool, for ST terminal blocks, also suitable for use as a bladed screwdriver, size: 0.6 x 3.5 x 100 mm, 2-component grip, with non-slip grip

Network cable

Network cable - VS-OE-OE-93E-100,0 - 1416295

<https://www.phoenixcontact.com/pc/products/1416295>



Network cable, Ethernet CAT5 (100 Mbps), 4-position halogen-free, shielded, free cable end, on free cable end, cable length: 100 m

Data connector - SACC-M12MSD-4CON-PG 9-SH



1521261

<https://www.phoenixcontact.com/pc/products/1521261>

Network cable

Network cable - VS-OE-OE-93B-100,0 - 1416389

<https://www.phoenixcontact.com/pc/products/1416389>



Network cable, PROFINET CAT5 (100 Mbps), 4-position, shielded, free cable end, on free cable end, cable length: 100 m

Network cable

Network cable - VS-OE-OE-93C-100,0 - 1416376

<https://www.phoenixcontact.com/pc/products/1416376>



Network cable, PROFINET CAT5 (100 Mbps), 4-position halogen-free, shielded, free cable end, on free cable end, cable length: 100 m, For drag chains

Data connector - SACC-M12MSD-4CON-PG 9-SH



1521261

<https://www.phoenixcontact.com/pc/products/1521261>

Network cable

Network cable - VS-OE-OE-93R-100,0 - 1416363

<https://www.phoenixcontact.com/pc/products/1416363>



Network cable, PROFINET CAT5 (100 Mbps), 4-position halogen-free, shielded, free cable end, on free cable end, cable length: 100 m, for robots

Network cable

Network cable - VS-OE-OE-936-100,0 - 1416570

<https://www.phoenixcontact.com/pc/products/1416570>



Network cable, PROFINET CAT5 (100 Mbps), 4-position halogen-free, shielded, free cable end, on free cable end, cable length: 100 m, For railway applications

Data connector - SACC-M12MSD-4CON-PG 9-SH



1521261

<https://www.phoenixcontact.com/pc/products/1521261>

Network cable

Network cable - VS-OE-OE-93G-100,0 - 1419152

<https://www.phoenixcontact.com/pc/products/1419152>



Network cable, EtherCAT[®] CAT5 (100 Mbps), 4-position, shielded, free cable end, on free cable end, cable length: 100 m

Network cable

Network cable - VS-OE-OE-93K-100,0 - 1419173

<https://www.phoenixcontact.com/pc/products/1419173>



Network cable, Sercos CAT5 (100 Mbps), 4-position, shielded, free cable end, on free cable end, cable length: 100 m

Data connector - SACC-M12MSD-4CON-PG 9-SH



1521261

<https://www.phoenixcontact.com/pc/products/1521261>

Ferrule

Ferrule - A 0,25- 5 - 3202465

<https://www.phoenixcontact.com/pc/products/3202465>

Ferrule, length: 5 mm, color: silver



Torque screwdriver

Torque screwdriver - TSD 04 SAC - 1208429

<https://www.phoenixcontact.com/pc/products/1208429>

Torque screwdriver, with preset torque of 0.4 Nm and 4 mm hexagonal drive for M12 connectors



Data connector - SACC-M12MSD-4CON-PG 9-SH



1521261

<https://www.phoenixcontact.com/pc/products/1521261>

Torque screwdriver

Torque screwdriver - TSD-M 1,2NM - 1212224

<https://www.phoenixcontact.com/pc/products/1212224>



Torque screw driver, accuracy as per EN ISO 6789 standard, adjustable from 0.3 - 1.2 Nm

Adapter insert

Adapter insert - TSD-M SAC-BIT ADAPTER - 1212600

<https://www.phoenixcontact.com/pc/products/1212600>



Adapter bit for TSD-M...torque tools, E6.3-1/4" drive with 4 mm hexagon to accommodate SAC bits

Data connector - SACC-M12MSD-4CON-PG 9-SH



1521261

<https://www.phoenixcontact.com/pc/products/1521261>

Sealing cap

Sealing cap - PROT-M12 FS-PA-CHAIN - 1430873

<https://www.phoenixcontact.com/pc/products/1430873>

M12 sealing cap made of plastic with fixing band, for sensor cables, for free M12 plugs



Crimping pliers

Crimping pliers - CRIMPFOX 6H - 1212046

<https://www.phoenixcontact.com/pc/products/1212046>

Crimping pliers, for ferrules without insulating collar according to DIN 46228 Part 1 and ferrules with insulating collar according to DIN 46228 Part 4, 0.14 mm² ... 6 mm², unlockable pressure lock, lateral entry



Data connector - SACC-M12MSD-4CON-PG 9-SH



1521261

<https://www.phoenixcontact.com/pc/products/1521261>

Tool

Tool - SACC BIT M12-D20 - 1208445

<https://www.phoenixcontact.com/pc/products/1208445>

Nut for assembling M12 connectors for assembly with a knurl diameter of 20 mm, for 4 mm hexagonal drive



Phoenix Contact 2022 © - all rights reserved

<https://www.phoenixcontact.com>

PHOENIX CONTACT GmbH & Co. KG

Flachsmarktstraße 8

D-32825 Blomberg

+49 (0) 5235-3 00

info@phoenixcontact.com