

# Power supply unit - QUINT4-PS/3AC/24DC/20



2904622

<https://www.phoenixcontact.com/pc/products/2904622>

Please be informed that the data shown in this PDF document is generated from our Online Catalog. Please find the complete data in the user documentation. Our General Terms of Use for Downloads are valid.



Primary-switched QUINT POWER power supply with free choice of output characteristic curve, SFB (selective fuse breaking) technology, and NFC interface, input: 3-phase, output: 24 V DC/20 A

## Product Description

The fourth generation of the high-performance QUINT POWER power supplies ensures superior system availability by means of new functions. Signaling thresholds and characteristic curves can be individually adjusted via the NFC interface. The unique SFB technology and preventive function monitoring of the QUINT POWER power supply increase the availability of your application.

## Your advantages

- SFB technology trips standard circuit breakers selectively, loads that are connected in parallel continue working
- Preventive function monitoring indicates critical operating states before errors occur
- Signaling thresholds and characteristic curves that can be adjusted via NFC maximize system availability
- Easy system extension thanks to static boost; starting of difficult loads thanks to dynamic boost
- High degree of immunity, thanks to integrated gas-filled surge arrester and mains failure bridging time of more than 20 milliseconds
- Robust design thanks to metal housing and wide temperature range from -40°C to +70°C
- Worldwide use thanks to the wide range input and international approval package

# Power supply unit - QUINT4-PS/3AC/24DC/20



2904622

<https://www.phoenixcontact.com/pc/products/2904622>

## Commercial Data

Item number	2904622
Packing unit	1 pc
Minimum order quantity	1 pc
Product Key	CMPI33
Catalog Page	Page 237 (C-4-2019)
GTIN	4046356986885
Weight per Piece (including packing)	1,581.433 g
Weight per Piece (excluding packing)	1,516.8 g
Customs tariff number	85044030
Country of origin	TH

## Technical Data

### Input data

#### AC operation

Network type	Star network
Nominal input voltage range	3x 400 V AC ... 500 V AC
	2x 400 V AC ... 500 V AC
Input voltage range	3x 400 V AC ... 500 V AC -20 % ... +10 %
	2x 400 V AC ... 500 V AC -10 % ... +10 %
Typical national grid voltage	400 V AC
	480 V AC
Voltage type of supply voltage	AC
Inrush current	typ. 2 A (at 25 °C)
Inrush current integral ( $I^2t$ )	< 0.1 A <sup>2</sup> s
Inrush current limitation	2 A (after 1 ms)
AC frequency range	50 Hz ... 60 Hz -10 % ... +10 %
Frequency range ( $f_N$ )	50 Hz ... 60 Hz -10 % ... +10 %
Mains buffering time	typ. 33 ms (3x 400 V AC)
	typ. 33 ms (3x 480 V AC)
Current consumption	3x 0.99 A (400 V AC)
	3x 0.81 A (480 V AC)
	2x 1.62 A (400 V AC)
	2x 1.37 A (480 V AC)
	3x 0.8 A (500 V AC)
	2x 1.23 A (500 V AC)
Nominal power consumption	541 VA
Protective circuit	Transient surge protection; Varistor, gas-filled surge arrester
Power factor (cos phi)	0.94
Switch-on time	< 1 s
Typical response time	300 ms (from SLEEP MODE)
Recommended breaker for input protection	3x 4 A ... 20 A (Characteristic B, C or comparable)
Recommended fuse for input protection	≥ 300 V AC
Discharge current to PE	< 3.5 mA
	1.7 mA (550 V AC, 60 Hz)

#### DC operation

Nominal input voltage range	± 260 V DC ... 300 V DC
Input voltage range	± 260 V DC ... 300 V DC -13 % ... +30 %
Voltage type of supply voltage	DC
Current consumption	1.23 A (± 260 V DC)
	1.06 A (±300 V DC)
Recommended breaker for input protection	1x 6 A (10 x 38 mm, 30 kA L/R = 2 ms)
Recommended fuse for input protection	≥ 1000 V DC

Control input (configurable) Rem	Output power ON/OFF (SLEEP MODE)
Default	Output power ON (>40 k $\Omega$ /24 V DC/open bridge between Rem and SGnd)

## Output data

Efficiency	typ. 93.9 % (400 V AC)
	typ. 93.8 % (480 V AC)
Output characteristic	U/I Advanced
	Smart HICCUP
	FUSE MODE
Nominal output voltage	24 V DC
Setting range of the output voltage ( $U_{Set}$ )	24 V DC ... 29.5 V DC (constant capacity)
Nominal output current ( $I_N$ )	20 A
Static Boost ( $I_{Stat.Boost}$ )	25 A
Dynamic Boost ( $I_{Dyn.Boost}$ )	30 A (5 s)
Selective Fuse Breaking ( $I_{SFB}$ )	120 A (15 ms)
Magnetic circuit breaker tripping	A1...A16 / B2...B13 / C1...C6 / Z1...Z16
Derating	> 60 °C ... 70 °C (2.5%/K)
Feedback voltage resistance	$\leq$ 35 V DC
Protection against overvoltage at the output (OVP)	$\leq$ 32 V DC
Control deviation	< 0.5 % (Static load change 10 % ... 90 %)
	< 3 % (Dynamic load change 10 % ... 90 %, (10 Hz))
	< 0.25 % (change in input voltage $\pm$ 10 %)
Residual ripple	< 60 mV <sub>PP</sub> (with nominal values)
Short-circuit-proof	yes
No-load proof	yes
Output power	480 W
	600 W
	720 W
Apparent power	686 VA (400 V, $U_{OUT} = 24$ V, $I_{OUT} = \text{stat. Boost}$ )
	698 VA (480 V, $U_{OUT} = 24$ V, $I_{OUT} = \text{stat. Boost}$ )
Maximum no-load power dissipation	< 7 W (400 V AC)
	< 7 W (480 V AC)
Power loss nominal load max.	< 32 W (400 V AC)
	< 33 W (480 V AC)
Power dissipation SLEEP MODE	< 5 W (400 V AC)
	< 5 W (480 V AC)
Crest factor	typ. 1.78 (400 V AC)
	typ. 2.1 (480 V AC)
Rise time	< 80 ms ( $U_{Out} = 10$ % ... 90 %)
Connection in parallel	yes, for redundancy and increased capacity
Connection in series	yes

## Signal

Signal ground SGnd	Reference potential for Out1, Out2, and Rem
--------------------	---

# Power supply unit - QUINT4-PS/3AC/24DC/20



2904622

<https://www.phoenixcontact.com/pc/products/2904622>

## Signal Out 1 (configurable)

Digital	24 V DC 20 mA
Default	24 V DC 20 mA 24 V DC for $U_{Out} > 0.9 \times U_{Set}$

## Signal Out 2 (configurable)

Digital	24 V DC 20 mA
Analog	4 mA ... 20 mA $\pm 5\%$ (Load $\leq 400 \Omega$ )
Default	24 V DC 20 mA 24 V DC for $P_{Out} < P_N$

## Signal relay 13/14 (configurable)

Default	closed ( $U_{out} > 0.9 U_{Set}$ )
Digital	24 V DC 1 A
	30 V AC/DC 0.5 A

## Connection data

### Input

Connection method	Screw connection
Conductor cross section solid min.	0.2 mm <sup>2</sup>
Conductor cross section solid max.	6 mm <sup>2</sup>
Conductor cross section flexible min.	0.2 mm <sup>2</sup>
Conductor cross section flexible max.	4 mm <sup>2</sup>
Single conductor/flexible terminal point with ferrule with plastic sleeve, min.	0.25 mm <sup>2</sup>
Single conductor/flexible terminal point with ferrule with plastic sleeve, max.	4 mm <sup>2</sup>
Single conductor/flexible terminal point with ferrule without plastic sleeve, min.	0.25 mm <sup>2</sup>
Single conductor/flexible terminal point with ferrule without plastic sleeve, max.	4 mm <sup>2</sup>
Conductor cross section AWG min.	24
Conductor cross section AWG max.	10
Stripping length	8 mm
Tightening torque, min	0.5 Nm
Tightening torque max	0.6 Nm

### Output

Connection method	Screw connection
Conductor cross section solid min.	0.2 mm <sup>2</sup>
Conductor cross section solid max.	6 mm <sup>2</sup>
Conductor cross section flexible min.	0.2 mm <sup>2</sup>
Conductor cross section flexible max.	4 mm <sup>2</sup>
Single conductor/flexible terminal point with ferrule with plastic sleeve, min.	0.25 mm <sup>2</sup>
Single conductor/flexible terminal point with ferrule with plastic sleeve, max.	4 mm <sup>2</sup>
Single conductor/flexible terminal point with ferrule without plastic	0.25 mm <sup>2</sup>

# Power supply unit - QUINT4-PS/3AC/24DC/20



2904622

<https://www.phoenixcontact.com/pc/products/2904622>

sleeve, min.	
Single conductor/flexible terminal point with ferrule without plastic sleeve, max.	4 mm <sup>2</sup>
Conductor cross section AWG min.	24
Conductor cross section AWG max.	10
Stripping length	8 mm
Tightening torque, min	0.5 Nm
Tightening torque max	0.6 Nm

## Signal

Connection method	Push-in connection
Conductor cross section solid min.	0.2 mm <sup>2</sup>
Conductor cross section solid max.	1 mm <sup>2</sup>
Conductor cross section flexible min.	0.2 mm <sup>2</sup>
Conductor cross section flexible max.	1.5 mm <sup>2</sup>
Single conductor/flexible terminal point with ferrule with plastic sleeve, min.	0.2 mm <sup>2</sup>
Single conductor/flexible terminal point with ferrule with plastic sleeve, max.	0.75 mm <sup>2</sup>
Single conductor/flexible terminal point with ferrule without plastic sleeve, min.	0.2 mm <sup>2</sup>
Single conductor/flexible terminal point with ferrule without plastic sleeve, max.	1.5 mm <sup>2</sup>
Conductor cross section AWG min.	24
Conductor cross section AWG max.	16
Stripping length	8 mm

## LED signaling

Types of signaling	LED
	Floating signal contact
	Active signal output Out1 (digital, configurable)
	Active signal output Out2 (analog, configurable)
	Remote contact
	Signal ground SGnd

## Signal output

P <sub>Out</sub>	> 100 % (LED lights up yellow, output power > 480 W)
U <sub>Out</sub>	> 0.9 x U <sub>Set</sub> (LED lights up green)

## Electrical properties

Number of phases	3.00
Insulation voltage input/output	4 kV AC (type test)
	2.4 kV AC (routine test)
Insulation voltage output / PE	0.5 kV DC (type test)
	0.5 kV DC (routine test)
Insulation voltage input / PE	3.5 kV AC (type test)

# Power supply unit - QUINT4-PS/3AC/24DC/20



2904622

<https://www.phoenixcontact.com/pc/products/2904622>

	2.4 kV AC (routine test)
Switching frequency	90 kHz ... 110 kHz (Auxiliary converter stage)
	56 kHz ... 500 kHz (Main converter stage)
	25 kHz ... 500 kHz (PFC stage)

## Product properties

Product type	Power supply
MTBF (IEC 61709, SN 29500)	> 985000 h (25 °C)
	> 638000 h (40 °C)
	> 311000 h (60 °C)
Environmental protection directive	RoHS Directive 2011/65/EU
	WEEE
	Reach

## Insulation characteristics

Protection class	I
Degree of pollution	2

## Life expectancy (electrolytic capacitors)

Current	10 A
Temperature	40 °C
Time	344000 h
Additional text	400 V AC

## Life expectancy (electrolytic capacitors)

Current	10 A
Temperature	40 °C
Time	320000 h
Additional text	480 V AC

## Life expectancy (electrolytic capacitors)

Current	20 A
Temperature	25 °C
Time	445000 h
Additional text	400 V AC

## Life expectancy (electrolytic capacitors)

Current	20 A
Temperature	25 °C
Time	432000 h
Additional text	480 V AC

## Life expectancy (electrolytic capacitors)

Current	20 A
Temperature	40 °C
Time	157000 h
Additional text	400 V AC

# Power supply unit - QUINT4-PS/3AC/24DC/20



2904622

<https://www.phoenixcontact.com/pc/products/2904622>

### Life expectancy (electrolytic capacitors)

Current	20 A
Temperature	40 °C
Time	152000 h
Additional text	480 V AC

### Dimensions

Dimensional drawing	
Width	70 mm
Height	130 mm
Depth	125 mm

### Installation dimensions

Installation distance right/left	5 mm / 5 mm
Installation distance top/bottom	50 mm / 50 mm

### Alternative assembly

Width	122 mm
Height	130 mm
Depth	73 mm

### Mounting

Mounting type	DIN rail mounting
Assembly instructions	alignable: $P_N \geq 50\%$ , 5 mm horizontally, 15 mm next to active components, 50 mm vertically alignable: $P_N < 50\%$ , 0 mm horizontally, 40 mm vertically top, 20 mm vertically bottom
Mounting position	horizontal DIN rail NS 35, EN 60715
With protective coating	No

### Material specifications

Inflammability class in acc. with UL 94 (housing / terminal blocks)	V0
Housing material	Metal
Hood version	Stainless steel X6Cr17
Side element version	Aluminum

### Environmental and real-life conditions

#### Ambient conditions



# Power supply unit - QUINT4-PS/3AC/24DC/20



2904622

<https://www.phoenixcontact.com/pc/products/2904622>

Degree of protection	IP20
Ambient temperature (operation)	-25 °C ... 70 °C (> 60 °C Derating: 2,5 %/K)
Ambient temperature (storage/transport)	-40 °C ... 85 °C
Ambient temperature (start-up type tested)	-40 °C
Maximum altitude	≤ 5000 m (> 2000 m, observe derating)
Climatic class	3K3 (in acc. with EN 60721)
Max. permissible relative humidity (operation)	≤ 95 % (at 25 °C, non-condensing)
Shock	18 ms, 30g, in each space direction (according to IEC 60068-2-27)
Vibration (operation)	5 Hz ... 100 Hz resonance search 2.3g, 90 min., resonance frequency 2.3g, 90 min. (according to DNV GL Class C)

## Standards and regulations

Rail applications	EN 50121-3-2
	EN 50121-4
	EN 50121-5
	IEC 62236-3-2
	IEC 62236-4
	IEC 62236-5
HART FSK Physical Layer Test Specification Compliance	Output voltage $U_{Out}$ compliant
Standard – Limitation of mains harmonic currents	EN 61000-3-2
Standard - Electrical safety	IEC 61010-2-201 (SELV)
Standard – Safety extra-low voltage	IEC 61010-1 (SELV)
	IEC 61010-2-201 (PELV)
Standard - Safe isolation	IEC 61558-2-16 pending
	IEC 61010-2-201
Standard - safety for equipment for measurement, control, and laboratory use	IEC 61010-1
Standard - Safety of transformers	IEC 61558-2-16 pending
Standard - power supply devices for low voltage with DC output	EN 61204-3
Battery charging	DIN 41773-1
Approval - requirement of the semiconductor industry with regard to mains voltage dips	SEMI F47-0706, EN 61000-4-11

## Overvoltage category

EN 61010-1	II (≤ 5000 m)
EN 62477-1	III (≤ 2000 m)

## Approval data

CSA	CAN/CSA-C22.2 No. 60950-1-07
	CSA-C22.2 No. 107.1-01
Shipbuilding approval	DNV GL, PRS, BV, LR, ABS
SIQ	BG (type approved)
UL approvals	UL Listed UL 508
	UL/C-UL Recognized UL 60950-1
	UL ANSI/ISA-12.12.01 Class I, Division 2, Groups A, B, C, D

# Power supply unit - QUINT4-PS/3AC/24DC/20



2904622

<https://www.phoenixcontact.com/pc/products/2904622>

	(Hazardous Location)
Conformity/Approvals	
SIL in accordance with IEC 61508	0

## EMC data

Low Voltage Directive	Conformance with Low Voltage Directive 2014/35/EC
Electromagnetic compatibility	Conformance with EMC Directive 2014/30/EU
EMC requirements for noise emission	EN 61000-6-3
	EN 61000-6-4
EMC requirements for noise immunity	EN 61000-6-1
	EN 61000-6-2
EMC requirements, power plant	IEC 61850-3
	EN 61000-6-5
Conducted noise emission	EN 55016
	EN 61000-6-3 (Class B)
Interference emission	Noise emission according to EN 61000-6-3 (residential and commercial) and EN 61000-6-4 (industrial)
Noise emission	Additional basic standard EN 61000-6-5 (immunity in power station), IEC/EN 61850-3 (energy supply)
Noise emission	EN 55016
	EN 61000-6-3 (Class B)
Noise immunity	Immunity according to EN 61000-6-1 (residential), EN 61000-6-2 (industrial), and EN 61000-6-5 (power station equipment zone), IEC/EN 61850-3 (energy supply)
DNV GL conducted interference	Class A
Additional text	Area power distribution
DNV GL noise radiation	Class B
Additional text	Bridge and deck area

## Harmonic currents

Standards/regulations	EN 61000-3-2
	EN 61000-3-2 (Class A)
Frequency range	0 kHz ... 2 kHz

## Flicker

Standards/regulations	EN 61000-3-3
	EN 61000-3-3
Frequency range	0 kHz ... 2 kHz

## Electrostatic discharge

Standards/regulations	EN 61000-4-2
-----------------------	--------------

## Electrostatic discharge

Contact discharge	8 kV (Test Level 4)
Discharge in air	15 kV (Test Level 4)
Comments	Criterion A

# Power supply unit - QUINT4-PS/3AC/24DC/20



2904622

<https://www.phoenixcontact.com/pc/products/2904622>

## Electromagnetic HF field

Standards/regulations	EN 61000-4-3
-----------------------	--------------

## Electromagnetic HF field

Frequency range	80 MHz ... 1 GHz
Test field strength	20 V/m (Test Level 3)
Frequency range	1 GHz ... 6 GHz
Test field strength	10 V/m (Test Level 3)
Frequency range	1 GHz ... 6 GHz
Test field strength	10 V/m (Test Level 3)
Comments	Criterion A

## Fast transients (burst)

Standards/regulations	EN 61000-4-4
-----------------------	--------------

## Fast transients (burst)

Input	4 kV (Test Level 4 - asymmetrical)
Output	4 kV (Test Level 4 - asymmetrical)
Signal	2 kV (Test Level 4 - asymmetrical)
Comments	Criterion A

## Surge voltage load (surge)

Standards/regulations	EN 61000-4-5
Input	3 kV (Test Level 4 - symmetrical) 6 kV (Test Level 4 - asymmetrical)
Output	1 kV (Test Level 3 - symmetrical) 2 kV (Test Level 3 - asymmetrical)
Signal	1 kV (Test Level 2 - asymmetrical)
Comments	Criterion A

## Conducted interference

Standards/regulations	EN 61000-4-6
-----------------------	--------------

## Conducted interference

I/O/S	asymmetrical
Frequency range	0.15 MHz ... 80 MHz
Comments	Criterion A
Voltage	10 V (Test Level 3)

## Power frequency magnetic field

Standards/regulations	EN 61000-4-8
Frequency	16.7 Hz 50 Hz 60 Hz
Test field strength	100 A/m
Additional text	60 s
Comments	Criterion A

# Power supply unit - QUINT4-PS/3AC/24DC/20



2904622

<https://www.phoenixcontact.com/pc/products/2904622>

Frequency	50 Hz
	60 Hz
Frequency range	50 Hz ... 60 Hz
Test field strength	1 kA/m
Additional text	3 s
Frequency	0 Hz
Test field strength	300 A/m
Additional text	DC, 60 s

## Voltage dips

Standards/regulations	EN 61000-4-11
Voltage	400 V AC
Frequency	50 Hz
Voltage dip	70 %
Number of periods	0.5 / 1 / 25 periods
Additional text	Test Level 2
Comments	Criterion A: 0.5 / 1 period Criterion B: 25 periods
Voltage dip	40 %
Number of periods	5 / 10 / 50 periods
Additional text	Test Level 2
Comments	Criterion B
Voltage dip	0 %
Number of periods	0,5 / 1 / 5 / 50 / 250 periods
Additional text	Test Level 2
Comments	Criterion A: 0.5 / 1 period Criterion B: 5 / 50 / 250 periods

## Pulse-shape magnetic field

Standards/regulations	EN 61000-4-9
Test field strength	1000 A/m
Comments	Criterion A

## Attenuated sinusoidal oscillations (ring wave)

Standards/regulations	EN 61000-4-12
Input	2 kV (Test Level 4 - symmetrical) 4 kV (Test Level 4 - asymmetrical)
Comments	Criterion A

## Asymmetrical conducted disturbance variables

Standards/regulations	EN 61000-4-16
Test level 1	15 Hz 150 Hz (Test Level 4)
Voltage	30 V 3 V
Test level 2	150 Hz 1.5 kHz (Test Level 4)
Voltage	3 V
Test level 3	1.5 kHz 15 kHz (Test Level 4)

# Power supply unit - QUINT4-PS/3AC/24DC/20



2904622

<https://www.phoenixcontact.com/pc/products/2904622>

Voltage	3 V 30 V
Test level 4	15 kHz 150 kHz (Test Level 4)
Voltage	30 V
Test level 5	16.7 Hz 50 Hz 60 Hz (Test Level 4)
Voltage	30 V (Permanent)
Test level 6	16.7 Hz 50 Hz 60 Hz (Test Level 4)
Voltage	300 V (1 s)
Comments	Criterion A

## Attenuated oscillating wave

Standards/regulations	EN 61000-4-18
Input, output (test level 1)	100 kHz 1 MHz (Test Level 3 - symmetrical)
Voltage	1 kV
Input, output (test level 2)	10 MHz
Voltage	1 kV
Input, output (test level 3)	100 kHz 1 MHz (Test Level 3 - asymmetrical)
Voltage	2.5 kV
Signals (test level 1)	100 kHz 1 MHz (Test Level 3 - symmetrical)
Voltage	1 kV
Signals (test level 2)	100 kHz 1 MHz (Test Level 3 - asymmetrical)
Voltage	2.5 kV
Comments	Criterion A

## Attenuated oscillating magnetic field

Standards/regulations	EN 61000-4-10
Test field strength	110 A/m
Test level 1	100 kHz
Test field strength	110 A/m
Test level 2	1 MHz
Comments	Criterion A
Criterion A	Normal operating behavior within the specified limits.
Criterion B	Temporary impairment to operational behavior that is corrected by the device itself.
Criterion C	Temporary adverse effects on the operating behavior, which the device corrects automatically or which can be restored by actuating the operating elements.

# Power supply unit - QUINT4-PS/3AC/24DC/20



2904622

<https://www.phoenixcontact.com/pc/products/2904622>

## Drawings

Dimensional drawing

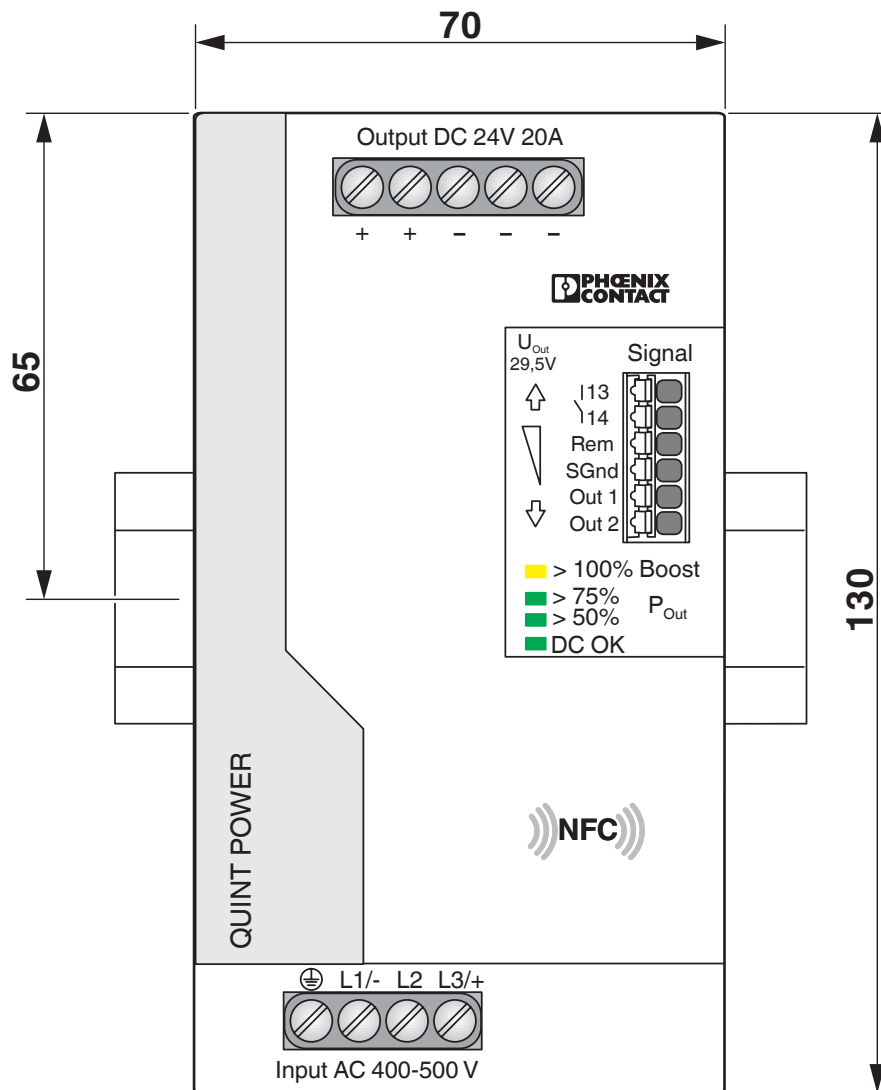

Diagram

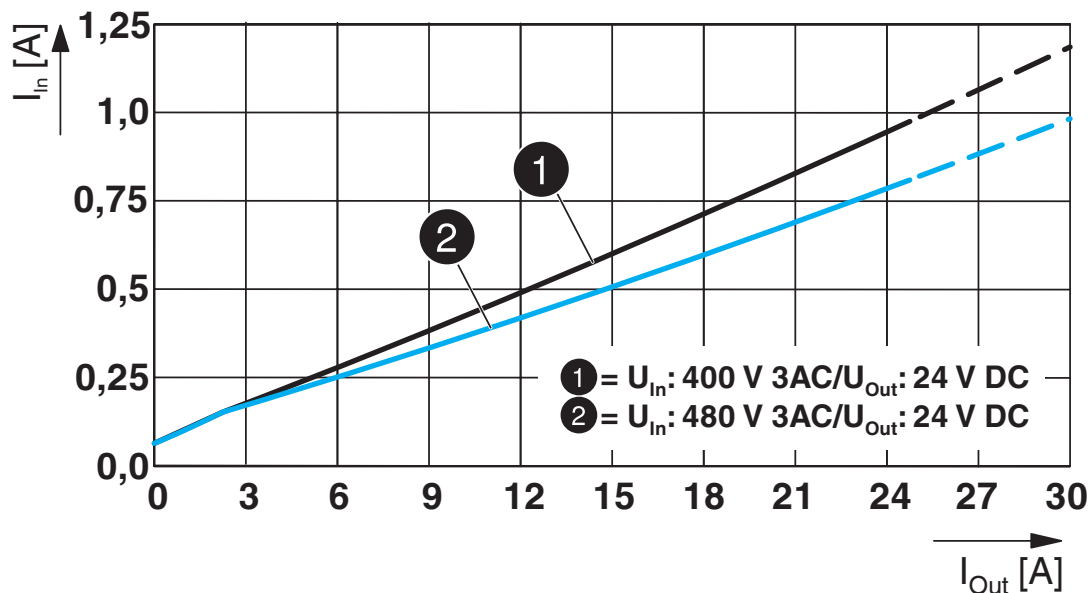

Diagram

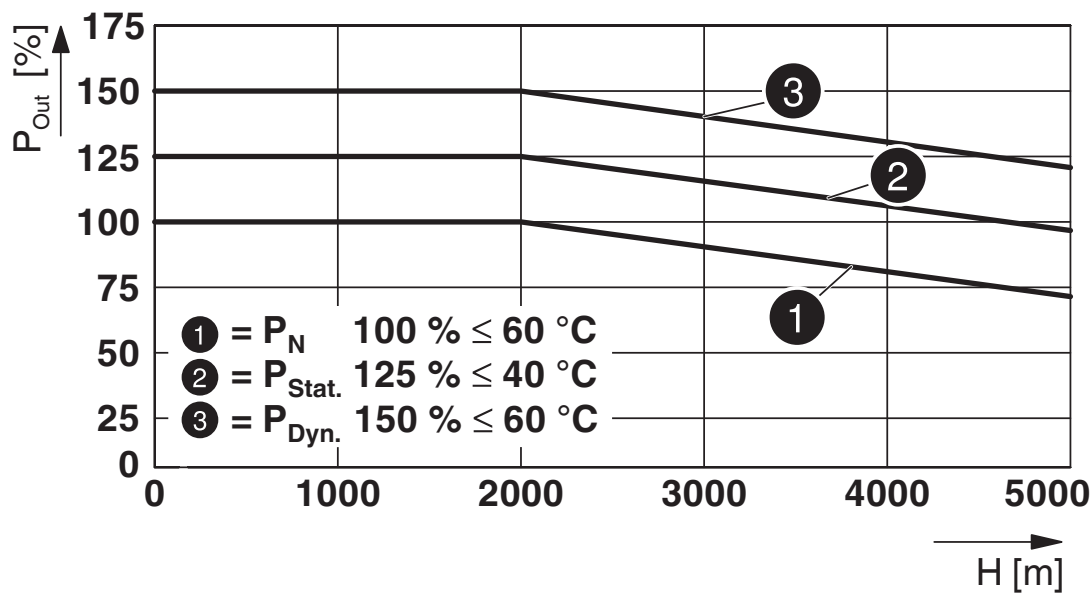

# Power supply unit - QUINT4-PS/3AC/24DC/20



2904622

<https://www.phoenixcontact.com/pc/products/2904622>

Block diagram

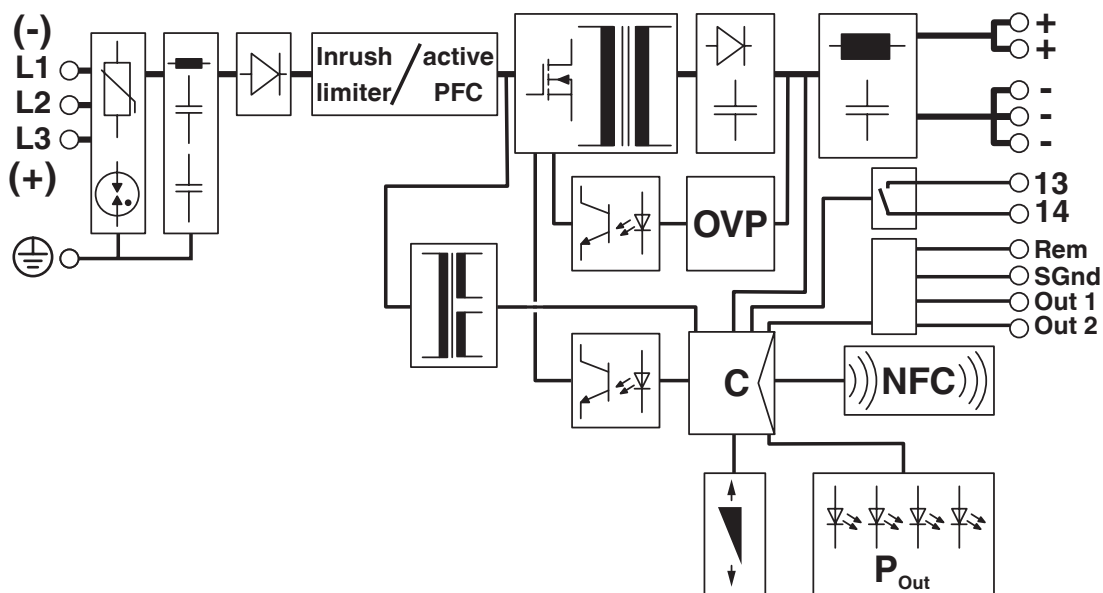

Dimensional drawing

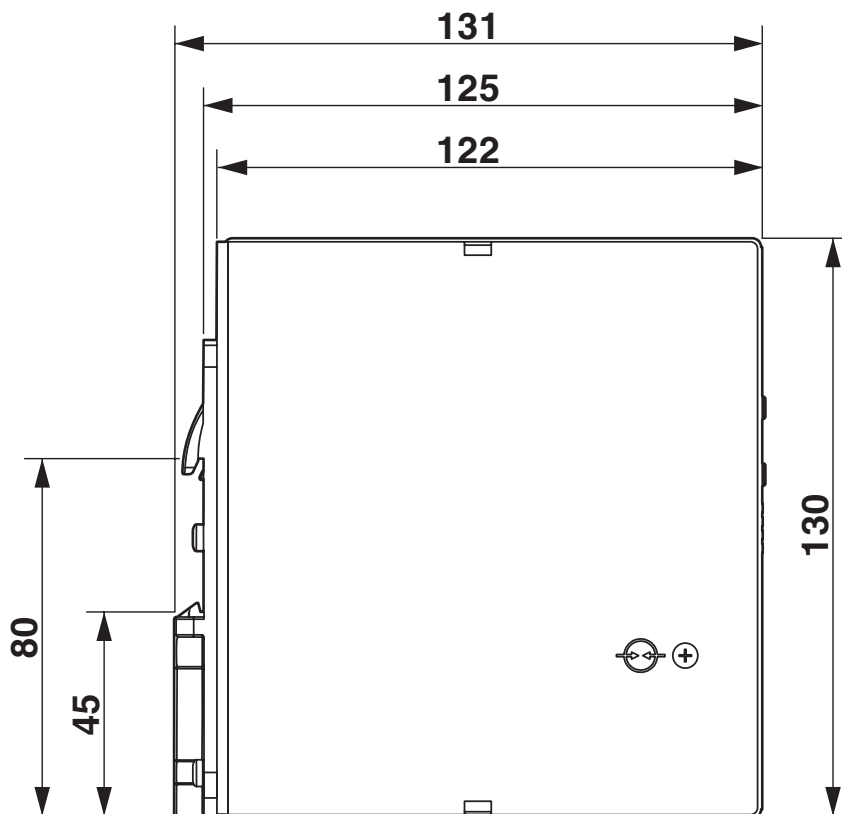



Diagram

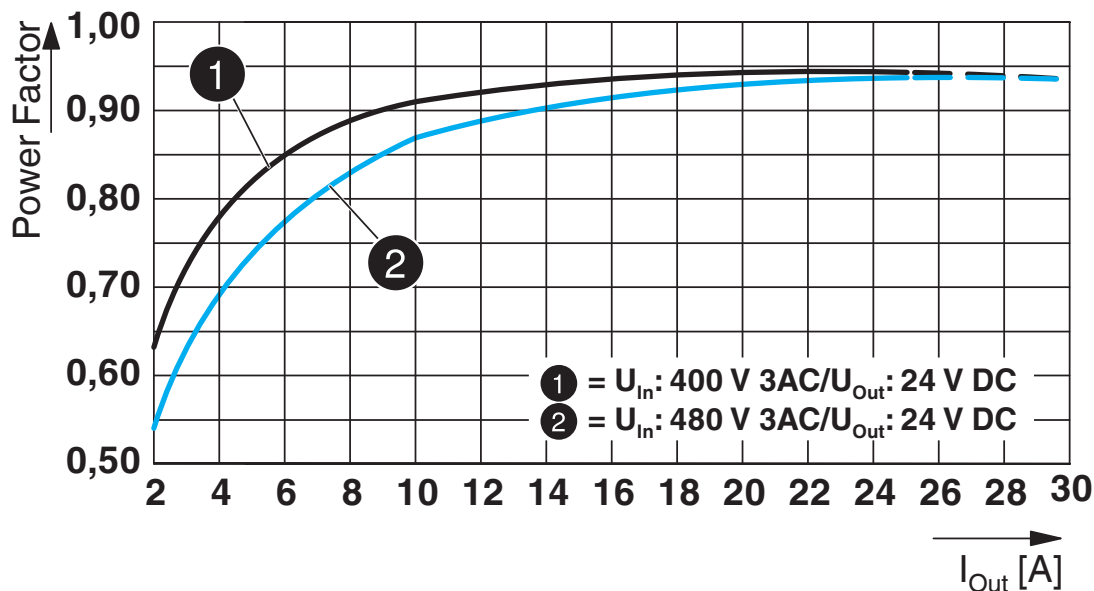

Diagram

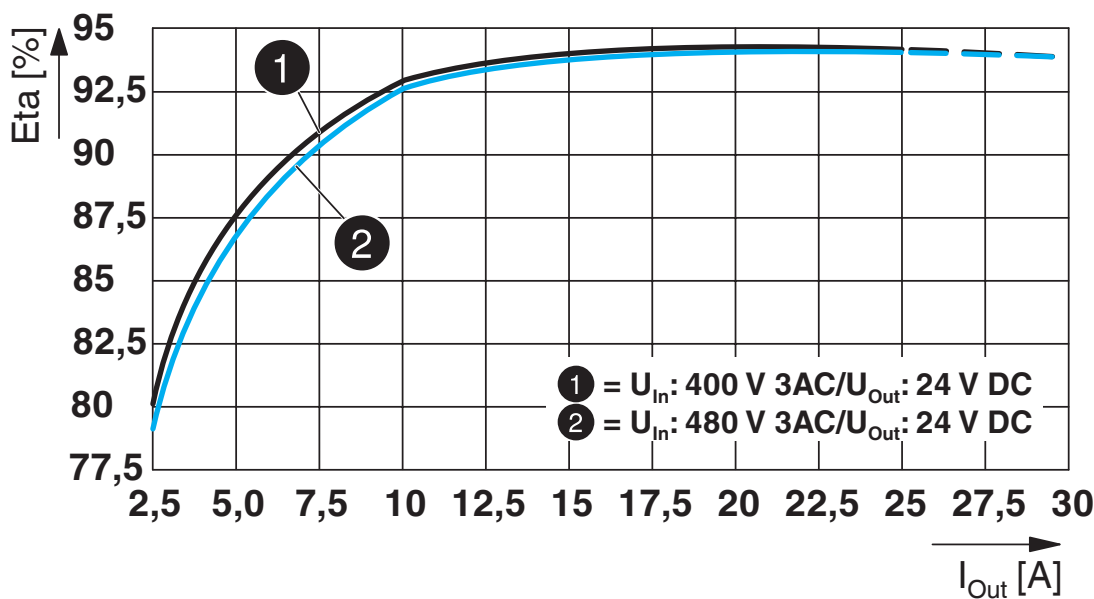

Schematic diagram

# Housing

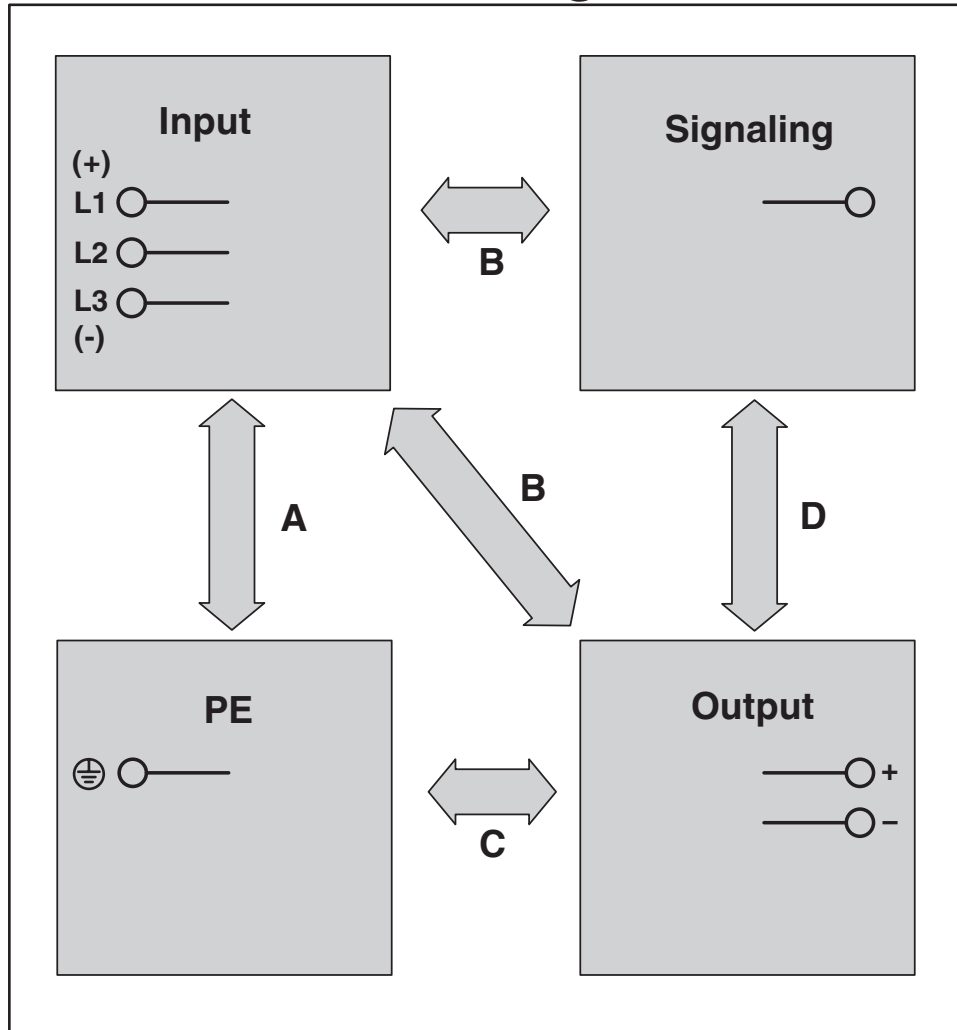

# Power supply unit - QUINT4-PS/3AC/24DC/20



2904622

<https://www.phoenixcontact.com/pc/products/2904622>

## Approvals



**UL Recognized**  
Approval ID: FILE E 211944



**CSA**  
Approval ID: 70098201



**cUL Recognized**  
Approval ID: FILE E 211944



**cUL Listed**  
Approval ID: FILE E 123528



**UL Listed**  
Approval ID: FILE E 123528

**ABS**

Approval ID: 20-1973616-PDA



**BV**  
Approval ID: 44621/A0 BV



**DNV GL**  
Approval ID: TAA00000BV

**ClassNK**

**NK**  
Approval ID: TA21182M



**LR**  
Approval ID: 17-20107-03



**Type approved**  
Approval ID: SI-SIQ BG 005/031 A1



**EAC**  
Approval ID: RU S-DE.BL08.W.00764

# Power supply unit - QUINT4-PS/3AC/24DC/20



2904622

<https://www.phoenixcontact.com/pc/products/2904622>

 **CSAus**  
Approval ID: 70098201

 **EAC**  
Approval ID: RU S-DE.BL08.W.00764

 **CSA**  
Approval ID: 70098201

 **cUL Recognized**  
Approval ID: FILE E 211944

 **UL Recognized**  
Approval ID: FILE E 211944

 **EAC**  
Approval ID: RU S-DE.BL08.W.00764

 **DNV GL**  
Approval ID: TAA00000BV

 **LR**  
Approval ID: 17-20107-03

 **ClassNK** **NK**  
Approval ID: TA21182M

 **BV**  
Approval ID: 44621/A0 BV

 **EAC**  
Approval ID: RU S-DE.BL08.W.00764

 **UL Listed**  
Approval ID: FILE E 123528

# Power supply unit - QUINT4-PS/3AC/24DC/20



2904622

<https://www.phoenixcontact.com/pc/products/2904622>



**cUL Listed**

Approval ID: FILE E 123528



**CSAus**

Approval ID: 70098201

**ABS**

Approval ID: 20-1973616-PDA



**Type approved**

Approval ID: SI-SIQ BG 005/031 A1



**UL Listed**

Approval ID: FILE E 199827



**cUL Listed**

Approval ID: FILE E 199827



**cUL Listed**

Approval ID: FILE E 199827



**UL Listed**

Approval ID: FILE E 199827

# Power supply unit - QUINT4-PS/3AC/24DC/20



2904622

<https://www.phoenixcontact.com/pc/products/2904622>

## Classifications

### ECLASS

ECLASS-9.0	27040701
ECLASS-10.0.1	27040701
ECLASS-11.0	27040701

### ETIM

ETIM 8.0	EC002540
----------	----------

### UNSPSC

UNSPSC 21.0	39121000
-------------	----------

# Power supply unit - QUINT4-PS/3AC/24DC/20



2904622

<https://www.phoenixcontact.com/pc/products/2904622>

## Environmental Product Compliance

REACH SVHC	Lead 7439-92-1
China RoHS	Environmentally Friendly Use Period = 25;
	For information on hazardous substances, refer to the manufacturer's declaration available under "Downloads"

# Power supply unit - QUINT4-PS/3AC/24DC/20



2904622

<https://www.phoenixcontact.com/pc/products/2904622>

## Accessories

### Fuse

Fuse - FUSE 10,3X38 6A PV A - 3062778

<https://www.phoenixcontact.com/pc/products/3062778>



Fuse, for the photovoltaics industry according to UL 2579, nominal current: 6 A, length: 38 mm, diameter: 10.3 mm, color: white

---

### Programming adapter

Programming adapter - TWN4 MIFARE NFC USB ADAPTER - 2909681

<https://www.phoenixcontact.com/pc/products/2909681>



Near Field Communication (NFC) programming adapter with USB interface for the wireless configuration of NFC-capable products from PHOENIX CONTACT with software. No separate USB driver is required.



# Power supply unit - QUINT4-PS/3AC/24DC/20

2904622

<https://www.phoenixcontact.com/pc/products/2904622>

## Type 3 surge protection device

Type 3 surge protection device - PLT-SEC-T3-3S-230-FM - 2905230

<https://www.phoenixcontact.com/pc/products/2905230>

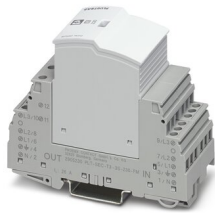

Plug-in device protection, according to type 3/class III, for 3-phase power supply networks with separate N and PE (5-conductor system: L1, L2, L3, N, PE), with integrated surge-proof fuse and remote indication contact.

---

## Type 3 surge protection device

Type 3 surge protection device - PLT-SEC-T3-24-FM-PT - 2907925

<https://www.phoenixcontact.com/pc/products/2907925>



Type 3 surge protection, consisting of protective plug and base element, with integrated status indicator and remote signaling for single-phase power supply networks. Nominal voltage: 24 V AC/DC

# Power supply unit - QUINT4-PS/3AC/24DC/20

2904622

<https://www.phoenixcontact.com/pc/products/2904622>

## Type 3 surge protection device

Type 3 surge protection device - PLT-SEC-T3-24-FM-UT - 2907916

<https://www.phoenixcontact.com/pc/products/2907916>



Type 3 surge protection, consisting of protective plug and base element, with integrated status indicator and remote signaling for single-phase power supply networks. Nominal voltage: 24 V AC/DC

---

## Mounting adapter

Mounting adapter - UWA 182/52 - 2938235

<https://www.phoenixcontact.com/pc/products/2938235>



Universal wall adapter for securely mounting the device in the event of strong vibrations. The device is screwed directly onto the mounting surface. The universal wall adapter is attached on the top/bottom.

# Power supply unit - QUINT4-PS/3AC/24DC/20



2904622

<https://www.phoenixcontact.com/pc/products/2904622>

## Mounting adapter

Mounting adapter - UWA 130 - 2901664

<https://www.phoenixcontact.com/pc/products/2901664>



2-piece universal wall adapter for securely mounting the device in the event of strong vibrations. The profiles that are screwed onto the side of the device are screwed directly onto the mounting surface. The universal wall adapter is attached on the left/right.

---

## Mounting adapter

Mounting adapter - QUINT-PS-ADAPTERS7/1 - 2938196

<https://www.phoenixcontact.com/pc/products/2938196>



Assembly adapter for QUINT-PS... power supply on S7-300 rail

# Power supply unit - QUINT4-PS/3AC/24DC/20



2904622

<https://www.phoenixcontact.com/pc/products/2904622>

## Electronic circuit breaker

Electronic circuit breaker - CBMC E4 24DC/1-4A NO - 2906031

<https://www.phoenixcontact.com/pc/products/2906031>



Multi-channel electronic circuit breaker for protecting four loads at 24 V DC in the event of overload and short circuit. With electronic locking of the set nominal currents. For installation on DIN rails.

---

## Electronic circuit breaker

Electronic circuit breaker - CBMC E4 24DC/1-10A NO - 2906032

<https://www.phoenixcontact.com/pc/products/2906032>



Multi-channel electronic circuit breaker for protecting four loads at 24 V DC in the event of overload and short circuit. With electronic locking of the set nominal currents. For installation on DIN rails.

# Power supply unit - QUINT4-PS/3AC/24DC/20



2904622

<https://www.phoenixcontact.com/pc/products/2904622>

## Electronic circuit breaker

Electronic circuit breaker - CBMC E4 24DC/1-4A+ IOL - 2910410

<https://www.phoenixcontact.com/pc/products/2910410>



Multi-channel electronic circuit breaker with IO-Link interface for protecting four loads at 24 V DC in the event of overload and short circuit. With electronic locking of the set nominal currents. For installation on DIN rails.

---

## Electronic circuit breaker

Electronic circuit breaker - CBMC E4 24DC/1-10A IOL - 2910411

<https://www.phoenixcontact.com/pc/products/2910411>



Multi-channel electronic circuit breaker with IO-Link interface for protecting four loads at 24 V DC in the event of overload and short circuit. With electronic locking of the set nominal currents. For installation on DIN rails.

# Power supply unit - QUINT4-PS/3AC/24DC/20



2904622

<https://www.phoenixcontact.com/pc/products/2904622>

## Electronic circuit breaker

Electronic circuit breaker - CBM E4 24DC/0.5-10A NO-R - 2905743

<https://www.phoenixcontact.com/pc/products/2905743>



Multi-channel, electronic circuit breaker with active current limitation for protecting four loads at 24 V DC in the event of overload and short circuit. With nominal current assistant and electronic locking of the set nominal currents. For installation on DIN rails.

---

## Electronic circuit breaker

Electronic circuit breaker - CBM E8 24DC/0.5-10A NO-R - 2905744

<https://www.phoenixcontact.com/pc/products/2905744>



Multi-channel, electronic circuit breaker with active current limitation for protecting eight loads at 24 V DC in the event of overload and short circuit. With nominal current assistant and electronic locking of the set nominal currents. For installation on DIN rails.

---

Phoenix Contact 2022 © - all rights reserved  
<https://www.phoenixcontact.com>

PHOENIX CONTACT GmbH & Co. KG  
Flachsmarktstraße 8  
D-32825 Blomberg  
+49 (0) 5235-3 00  
[info@phoenixcontact.com](mailto:info@phoenixcontact.com)