

Plug - PP-H 2,5/1-R GNYE

3210143

<https://www.phoenixcontact.com/pc/products/3210143>



Please be informed that the data shown in this PDF document is generated from our Online Catalog. Please find the complete data in the user documentation. Our General Terms of Use for Downloads are valid.



Plug, nom. voltage: 500 V, nominal current: 24 A, connection method: Push-in connection, 1 level, Rated cross section: 2.5 mm², cross section: 0.14 mm² - 4 mm², color: green-yellow

Product Description

Connector element right, left housing with engagement pin, right closed with cover

Your advantages

- Large-surface labeling option
- The Push-in technology COMBI plugs for self-assembly provide solutions that users can implement themselves
- Tested for railway applications

Plug - PP-H 2,5/1-R GNYE

3210143

<https://www.phoenixcontact.com/pc/products/3210143>



Commercial Data

Item number	3210143
Packing unit	50 pc
Minimum order quantity	1 pc
Product Key	BE2244
Catalog Page	Page 299 (C-1-2019)
GTIN	4046356333559
Weight per Piece (including packing)	3.746 g
Weight per Piece (excluding packing)	3.695 g
Customs tariff number	85366990
Country of origin	PL

Plug - PP-H 2,5/1-R GNYE



3210143

<https://www.phoenixcontact.com/pc/products/3210143>

Technical Data

Product properties

Product type	Terminal plug
Number of positions	1
Pitch	5.2 mm
Area of application	Railway industry
	Machine building
	Plant engineering
Number of connections	1
Number of rows	1
Potentials	1

Insulation characteristics

Overvoltage category	III
Degree of pollution	3

Electrical properties

Rated surge voltage	6 kV
Maximum power dissipation for nominal condition	0.77 W

Connection data

Number of connections per level	1
Nominal cross section	2.5 mm ²

1 level

Stripping length	8 mm ... 10 mm
Internal cylindrical gage	A3
Conductor cross section solid	0.14 mm ² ... 4 mm ²
Cross section AWG	26 ... 12
Conductor cross section flexible	0.14 mm ² ... 2.5 mm ²
Conductor cross section, flexible [AWG]	26 ... 14
Flexible conductor cross section flexible (ferrule, w/o plastic sleeve)	0.14 mm ² ... 2.5 mm ²
Flexible conductor cross section (ferrule with plastic sleeve)	0.14 mm ² ... 2.5 mm ²
2 conductors with the same cross section, flexible, with TWIN ferrule with plastic sleeve	0.5 mm ²
Nominal current	24 A
Maximum load current	24 A (with 4 mm ² conductor cross section)
Nominal voltage	500 V
Nominal cross section	2.5 mm ²

1 level Connection cross sections directly pluggable

Conductor cross section solid	0.34 mm ² ... 4 mm ²
Flexible conductor cross section flexible (ferrule, w/o plastic sleeve)	0.34 mm ² ... 2.5 mm ²

Plug - PP-H 2,5/1-R GNYE



3210143

<https://www.phoenixcontact.com/pc/products/3210143>

Flexible conductor cross section (ferrule with plastic sleeve)	0.34 mm ² ... 2.5 mm ²
--	--

Dimensions

Width	5.2 mm
Height	40.2 mm
Length	15.8 mm
Pitch	5.2 mm

Material specifications

Color	green-yellow
Flammability rating according to UL 94	V0
Insulating material group	I
Insulating material	PA
Static insulating material application in cold	-60 °C
Temperature index of insulation material (DIN EN 60216-1 (VDE 0304-21))	130 °C
Relative insulation material temperature index (Elec., UL 746 B)	130 °C
Fire protection for rail vehicles (DIN EN 45545-2) R22	HL 1 - HL 3
Fire protection for rail vehicles (DIN EN 45545-2) R23	HL 1 - HL 3
Fire protection for rail vehicles (DIN EN 45545-2) R24	HL 1 - HL 3
Fire protection for rail vehicles (DIN EN 45545-2) R26	HL 1 - HL 3
Calorimetric heat release NFPA 130 (ASTM E 1354)	28 MJ/kg
Surface flammability NFPA 130 (ASTM E 162)	passed
Specific optical density of smoke NFPA 130 (ASTM E 662)	passed
Smoke gas toxicity NFPA 130 (SMP 800C)	passed

Mechanical properties

Mechanical data

Open side panel	No
-----------------	----

Environmental and real-life conditions

Ambient conditions

Ambient temperature (operation)	-60 °C ... 105 °C (max. short-term operating temperature RTI Elec.)
Ambient temperature (storage/transport)	-25 °C ... 60 °C (for a short time, not exceeding 24 h, -60 °C to +70 °C)
Ambient temperature (assembly)	-5 °C ... 70 °C
Ambient temperature (actuation)	-5 °C ... 70 °C
Permissible humidity (storage/transport)	30 % ... 70 %

Standards and regulations

Connection in acc. with standard	IEC 61984
----------------------------------	-----------

Mounting

Assembly instructions	Use of a parallel pressing tool is recommended for easy latching
-----------------------	--

Plug - PP-H 2,5/1-R GNYE

3210143

<https://www.phoenixcontact.com/pc/products/3210143>



of the COMBI connector and coupling elements for self-assembly

Plug - PP-H 2,5/1-R GNYE

3210143

<https://www.phoenixcontact.com/pc/products/3210143>



Drawings

Circuit diagram



Plug - PP-H 2,5/1-R GNYE

3210143

<https://www.phoenixcontact.com/pc/products/3210143>



Schematic diagram

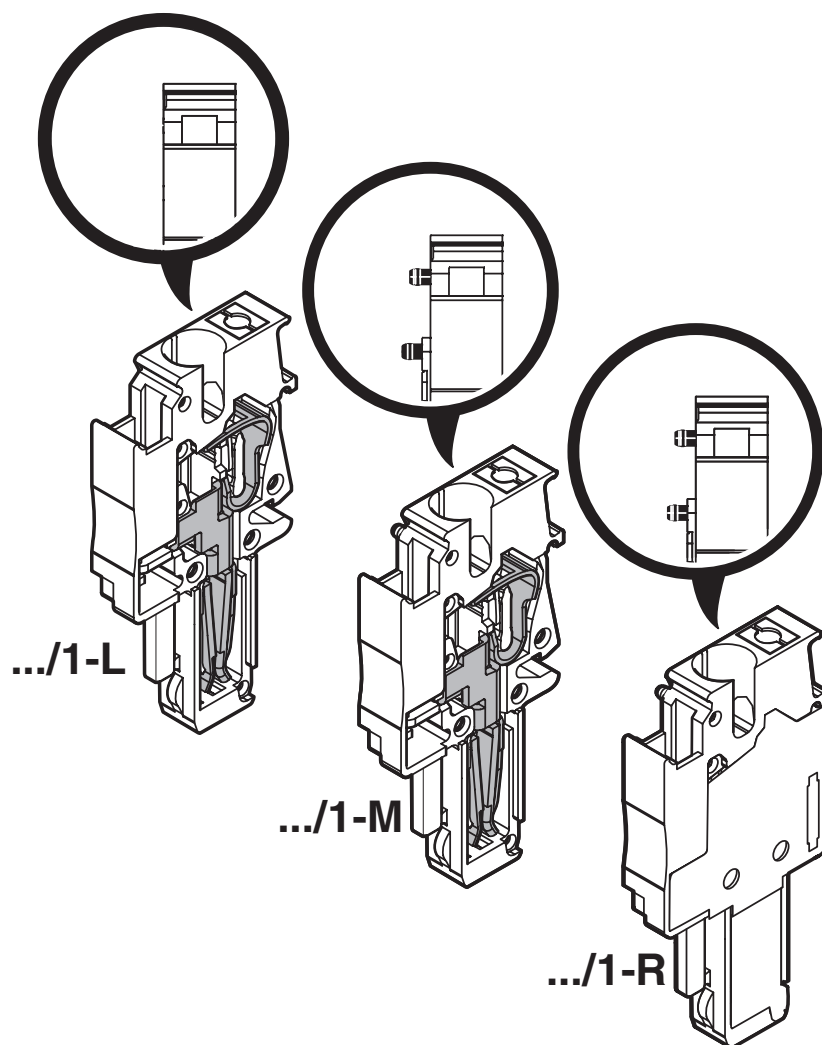

Plug - PP-H 2,5/1-R GNYE



3210143

<https://www.phoenixcontact.com/pc/products/3210143>

Approvals

DNV

Approval ID: TAE00003JE



CSA

Approval ID: 13631

	Nominal Voltage U_N	Nominal Current I_N	Cross Section AWG	Cross Section mm^2
Use group B				
	300 V	20 A	26 - 12	-
Use group C				
	300 V	20 A	26 - 12	-



EAC

Approval ID: RU C-DE.BL08.B.00511



cULus Recognized

Approval ID: E60425

	Nominal Voltage U_N	Nominal Current I_N	Cross Section AWG	Cross Section mm^2
Use group B				
			26 - 12	-
Use group C				
			26 - 12	-
Use group D				
			26 - 12	-



LR

Approval ID: 12/20038 (E3)



NK

Approval ID: 14ME0912



RS

Approval ID: 17.00013.272



BV

Approval ID: 25278/B0 BV

	Nominal Voltage U_N	Nominal Current I_N	Cross Section AWG	Cross Section mm^2
			-	-

Plug - PP-H 2,5/1-R GNYE

3210143

<https://www.phoenixcontact.com/pc/products/3210143>



ABS

Approval ID: 21-2192245-PDA

Plug - PP-H 2,5/1-R GNYE



3210143

<https://www.phoenixcontact.com/pc/products/3210143>

Classifications

ECLASS

ECLASS-9.0	27141151
ECLASS-10.0.1	27141151
ECLASS-11.0	27141151

ETIM

ETIM 8.0	EC002021
----------	----------

UNSPSC

UNSPSC 21.0	39121400
-------------	----------

Plug - PP-H 2,5/1-R GNYE

3210143

<https://www.phoenixcontact.com/pc/products/3210143>



Environmental Product Compliance

China RoHS	Environmentally friendly use period: unlimited = EFUP-e
	No hazardous substances above threshold values

Plug - PP-H 2,5/1-R GNYE

3210143

<https://www.phoenixcontact.com/pc/products/3210143>



Accessories

Actuation tool

Actuation tool - ST-BW - 1207608

<https://www.phoenixcontact.com/pc/products/1207608>

Actuation tool, for all 2.5 mm² - 4.0 mm² spring-cages



Flange cover

Flange cover - DF-SP-H 2,5 - 3209824

<https://www.phoenixcontact.com/pc/products/3209824>

Flange cover, length: 35.8 mm, width: 4.5 mm, height: 24.7 mm, color: gray



Plug - PP-H 2,5/1-R GNYE

3210143

<https://www.phoenixcontact.com/pc/products/3210143>



Flange cover

Flange cover - DFS-SP-H 2,5 - 3061431

<https://www.phoenixcontact.com/pc/products/3061431>



Flange cover, length: 35.8 mm, width: 4.5 mm, height: 24.7 mm, color: gray

Zack Marker strip, flat

Zack Marker strip, flat - ZBF 5:UNBEDRUCKT - 0808642

<https://www.phoenixcontact.com/pc/products/0808642>



Zack Marker strip, flat, Strip, white, unlabeled, can be labeled with: PLOTMARK, CMS-P1-PLOTTER, mounting type: snap in, for terminal block width: 5 mm, lettering field size: 5.1 x 5.2 mm, Number of individual labels: 10

Plug - PP-H 2,5/1-R GNYE

3210143

<https://www.phoenixcontact.com/pc/products/3210143>



Zack Marker strip, flat

Zack Marker strip, flat - ZBF 5 CUS - 0825025

<https://www.phoenixcontact.com/pc/products/0825025>



Zack Marker strip, flat, can be ordered: Strip, white, labeled according to customer specifications, mounting type: snap into flat marker groove, for terminal block width: 5 mm, lettering field size: 5.15 x 5.15 mm, Number of individual labels: 10

Zack Marker strip, flat

Zack Marker strip, flat - ZBF 5,LGS:FORTL.ZAHLEN - 0808671

<https://www.phoenixcontact.com/pc/products/0808671>



Zack Marker strip, flat, Strip, white, labeled, printed horizontally: consecutive numbers 1 ... 10, 11 ... 20, etc. up to 491 ... 500, mounting type: snap into flat marker groove, for terminal block width: 5 mm, lettering field size: 5.15 x 5.15 mm, Number of individual labels: 10

Plug - PP-H 2,5/1-R GNYE

3210143

<https://www.phoenixcontact.com/pc/products/3210143>



Zack Marker strip, flat

Zack Marker strip, flat - ZBF 5,QR:FORTL.ZAHLEN - 0808697

<https://www.phoenixcontact.com/pc/products/0808697>

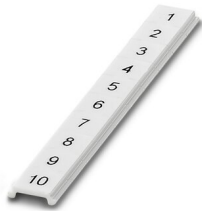

Zack Marker strip, flat, Strip, white, labeled, Printed vertically: consecutive numbers 1 ... 10, 11 ... 20, etc. up to 91 ... 100, mounting type: snap into flat marker groove, for terminal block width: 5 mm, lettering field size: 5.15 x 5.15 mm, Number of individual labels: 10

Zack Marker strip, flat

Zack Marker strip, flat - ZBF 5,LGS:GERADE ZAHLEN - 0810821

<https://www.phoenixcontact.com/pc/products/0810821>



Zack Marker strip, flat, Strip, white, labeled, printed horizontally: consecutive even numbers 2 ... 20, 22 ... 40, etc. up to 82 ... 100, mounting type: snap into flat marker groove, for terminal block width: 5 mm, lettering field size: 5.15 x 5.15 mm, Number of individual labels: 10

Plug - PP-H 2,5/1-R GNYE

3210143

<https://www.phoenixcontact.com/pc/products/3210143>



Zack Marker strip, flat

Zack Marker strip, flat - ZBF 5,LGS:UNGERADE ZAHLEN - 0810863

<https://www.phoenixcontact.com/pc/products/0810863>



Zack Marker strip, flat, Strip, white, labeled, printed horizontally: Odd numbers 1 - 19, 21 - 39, etc. up to 81 - 99, mounting type: snap into flat marker groove, for terminal block width: 5 mm, lettering field size: 5.15 x 5.15 mm, Number of individual labels: 10

Latching

Latching - PR - 3040559

<https://www.phoenixcontact.com/pc/products/3040559>



Latching, length: 29.8 mm, width: 4.4 mm, number of positions: 1, color: orange

Plug - PP-H 2,5/1-R GNYE

3210143

<https://www.phoenixcontact.com/pc/products/3210143>



Latching

Latching - PR/2 - 3040630

<https://www.phoenixcontact.com/pc/products/3040630>



Latching, length: 29.8 mm, width: 10 mm, number of positions: 2, color: orange

Latching

Latching - PRT/2 - 3040631

<https://www.phoenixcontact.com/pc/products/3040631>



Latching, can only be released using a screwdriver, length: 23.2 mm, width: 9 mm, number of positions: 2, color: orange

Plug - PP-H 2,5/1-R GNYE

3210143

<https://www.phoenixcontact.com/pc/products/3210143>



Latching

Latching - PRZ - 3040614

<https://www.phoenixcontact.com/pc/products/3040614>



Latching, color: orange

Strain relief

Strain relief - PZ/2 - 3040627

<https://www.phoenixcontact.com/pc/products/3040627>



Strain relief, length: 48.7 mm, width: 9.3 mm, number of positions: 2, color: black

Plug - PP-H 2,5/1-R GNYE

3210143

<https://www.phoenixcontact.com/pc/products/3210143>



Strain relief

Strain relief - PZ/4 - 3040643

<https://www.phoenixcontact.com/pc/products/3040643>

Strain relief, length: 48.7 mm, width: 19.6 mm, number of positions: 4, color: black



Insulating sleeve

Insulating sleeve - MPS-IH WH - 0201663

<https://www.phoenixcontact.com/pc/products/0201663>

Insulating sleeve, color: white



Plug - PP-H 2,5/1-R GNYE

3210143

<https://www.phoenixcontact.com/pc/products/3210143>



Insulating sleeve

Insulating sleeve - MPS-IH RD - 0201676

<https://www.phoenixcontact.com/pc/products/0201676>

Insulating sleeve, color: red



Insulating sleeve

Insulating sleeve - MPS-IH BU - 0201689

<https://www.phoenixcontact.com/pc/products/0201689>

Insulating sleeve, color: blue

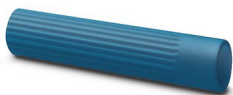

Plug - PP-H 2,5/1-R GNYE

3210143

<https://www.phoenixcontact.com/pc/products/3210143>



Insulating sleeve

Insulating sleeve - MPS-IH YE - 0201692

<https://www.phoenixcontact.com/pc/products/0201692>

Insulating sleeve, color: yellow



Insulating sleeve

Insulating sleeve - MPS-IH GN - 0201702

<https://www.phoenixcontact.com/pc/products/0201702>

Insulating sleeve, color: green



Plug - PP-H 2,5/1-R GNYE

3210143

<https://www.phoenixcontact.com/pc/products/3210143>



Insulating sleeve

Insulating sleeve - MPS-IH GY - 0201728

<https://www.phoenixcontact.com/pc/products/0201728>

Insulating sleeve, color: gray



Insulating sleeve

Insulating sleeve - MPS-IH BK - 0201731

<https://www.phoenixcontact.com/pc/products/0201731>

Insulating sleeve, color: black



Plug - PP-H 2,5/1-R GNYE

3210143

<https://www.phoenixcontact.com/pc/products/3210143>



Insulating sleeve

Insulating sleeve - ISH 2,5/0,2 - 3002843

<https://www.phoenixcontact.com/pc/products/3002843>



Insulating sleeve, color: white

Insulating sleeve

Insulating sleeve - ISH 2,5/0,5 - 3002856

<https://www.phoenixcontact.com/pc/products/3002856>



Insulating sleeve, color: gray

Plug - PP-H 2,5/1-R GNYE

3210143

<https://www.phoenixcontact.com/pc/products/3210143>



Insulating sleeve

Insulating sleeve - ISH 2,5/1,0 - 3002869

<https://www.phoenixcontact.com/pc/products/3002869>



Insulating sleeve, color: black

Cable housing

Cable housing - PH 2,5/ 2 - 3209691

<https://www.phoenixcontact.com/pc/products/3209691>



Cable housing, pitch: 10.4 mm, length: 19.9 mm, width: 10.4 mm, height: 36.8 mm, number of positions: 2, color: gray

Plug - PP-H 2,5/1-R GNYE

3210143

<https://www.phoenixcontact.com/pc/products/3210143>



Cable housing

Cable housing - PH 2,5/ 3 - 3209701

<https://www.phoenixcontact.com/pc/products/3209701>



Cable housing, pitch: 15.6 mm, length: 19.9 mm, width: 15.6 mm, height: 36.8 mm, number of positions: 3, color: gray

Cable housing

Cable housing - PH 2,5/ 4 - 3209714

<https://www.phoenixcontact.com/pc/products/3209714>

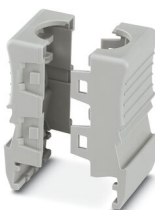

Cable housing, pitch: 20.8 mm, length: 19.9 mm, width: 20.8 mm, height: 36.8 mm, number of positions: 4, color: gray

Plug - PP-H 2,5/1-R GNYE

3210143

<https://www.phoenixcontact.com/pc/products/3210143>



Cable housing

Cable housing - PH 2,5/ 5 - 3209727

<https://www.phoenixcontact.com/pc/products/3209727>



Cable housing, pitch: 26 mm, length: 19.9 mm, width: 26 mm, height: 36.8 mm, number of positions: 5, color: gray

Cable housing

Cable housing - PH 2,5/ 6 - 3209730

<https://www.phoenixcontact.com/pc/products/3209730>



Cable housing, pitch: 31.2 mm, length: 19.9 mm, width: 31.2 mm, height: 36.8 mm, number of positions: 6, color: gray

Plug - PP-H 2,5/1-R GNYE

3210143

<https://www.phoenixcontact.com/pc/products/3210143>



Cable housing

Cable housing - PH 2,5/ 7 - 3209743

<https://www.phoenixcontact.com/pc/products/3209743>



Cable housing, pitch: 36.4 mm, length: 19.9 mm, width: 36.4 mm, height: 36.8 mm, number of positions: 7, color: gray

Cable housing

Cable housing - PH 2,5/ 8 - 3209756

<https://www.phoenixcontact.com/pc/products/3209756>



Cable housing, pitch: 41.6 mm, length: 19.9 mm, width: 41.6 mm, height: 36.8 mm, number of positions: 8, color: gray

Plug - PP-H 2,5/1-R GNYE

3210143

<https://www.phoenixcontact.com/pc/products/3210143>



Cable housing

Cable housing - PH 2,5/ 9 - 3209507

<https://www.phoenixcontact.com/pc/products/3209507>

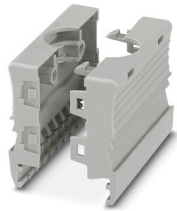

Cable housing, pitch: 46.8 mm, length: 19.9 mm, width: 46.8 mm, height: 36.8 mm, number of positions: 9, color: gray

Cable housing

Cable housing - PH 2,5/10 - 3209769

<https://www.phoenixcontact.com/pc/products/3209769>



Cable housing, pitch: 52 mm, length: 19.9 mm, width: 52 mm, height: 36.8 mm, number of positions: 10, color: gray

Plug - PP-H 2,5/1-R GNYE

3210143

<https://www.phoenixcontact.com/pc/products/3210143>



Cable housing

Cable housing - PH 2,5/11 - 3209772

<https://www.phoenixcontact.com/pc/products/3209772>

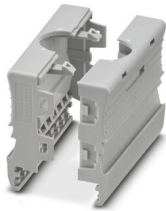

Cable housing, pitch: 57.2 mm, length: 19.9 mm, width: 57.2 mm, height: 36.8 mm, number of positions: 11, color: gray

Cable housing

Cable housing - PH 2,5/12 - 3209785

<https://www.phoenixcontact.com/pc/products/3209785>

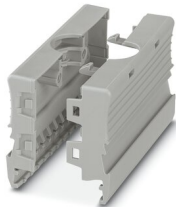

Cable housing, pitch: 62.4 mm, length: 19.9 mm, width: 62.4 mm, height: 36.8 mm, number of positions: 12, color: gray

Plug - PP-H 2,5/1-R GNYE

3210143

<https://www.phoenixcontact.com/pc/products/3210143>



Cable housing

Cable housing - PH 2,5/13 - 3209798

<https://www.phoenixcontact.com/pc/products/3209798>

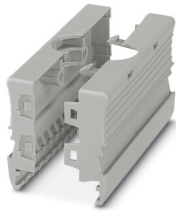

Cable housing, pitch: 67.6 mm, length: 19.9 mm, width: 67.6 mm, height: 36.8 mm, number of positions: 13, color: gray

Cable housing

Cable housing - PH 2,5/14 - 3209808

<https://www.phoenixcontact.com/pc/products/3209808>

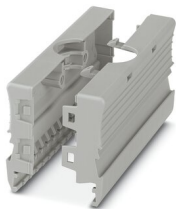

Cable housing, pitch: 72.8 mm, length: 19.9 mm, width: 72.8 mm, height: 36.8 mm, number of positions: 14, color: gray

Plug - PP-H 2,5/1-R GNYE

3210143

<https://www.phoenixcontact.com/pc/products/3210143>



Cable housing

Cable housing - PH 2,5/15 - 3209811

<https://www.phoenixcontact.com/pc/products/3209811>

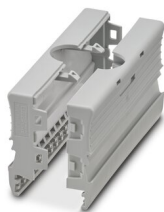

Cable housing, pitch: 78 mm, length: 19.9 mm, width: 78 mm, height: 36.8 mm, number of positions: 15, color: gray

Marker for terminal blocks

Marker for terminal blocks - UC-TMF 5 - 0818153

<https://www.phoenixcontact.com/pc/products/0818153>



Marker for terminal blocks, Sheet, white, unlabeled, can be labeled with: BLUEMARK ID COLOR, BLUEMARK ID, BLUEMARK CLED, PLOTMARK, CMS-P1-PLOTTER, mounting type: snap in, for terminal block width: 5.2 mm, lettering field size: 4.6 x 5.1 mm, Number of individual labels: 96

Plug - PP-H 2,5/1-R GNYE

3210143

<https://www.phoenixcontact.com/pc/products/3210143>



Marker for terminal blocks

Marker for terminal blocks - UC-TMF 5 CUS - 0824638

<https://www.phoenixcontact.com/pc/products/0824638>



Marker for terminal blocks, can be ordered: by sheet, white, labeled according to customer specifications, mounting type: snap into flat marker groove, for terminal block width: 5.2 mm, lettering field size: 4.6 x 5.1 mm, Number of individual labels: 96

Marker for terminal blocks

Marker for terminal blocks - UCT-TMF 5 - 0828744

<https://www.phoenixcontact.com/pc/products/0828744>



Marker for terminal blocks, Sheet, white, unlabeled, can be labeled with: TOPMARK NEO, TOPMARK LASER, BLUEMARK ID COLOR, BLUEMARK ID, BLUEMARK CLED, THERMOMARK PRIME, THERMOMARK CARD 2.0, THERMOMARK CARD, mounting type: snap in, for terminal block width: 5.2 mm, lettering field size: 4.4 x 4.7 mm, Number of individual labels: 72

Plug - PP-H 2,5/1-R GNYE

3210143

<https://www.phoenixcontact.com/pc/products/3210143>



Marker for terminal blocks

Marker for terminal blocks - UCT-TMF 5 CUS - 0829658

<https://www.phoenixcontact.com/pc/products/0829658>



Marker for terminal blocks, can be ordered: by sheet, white, labeled according to customer specifications, mounting type: snap into flat marker groove, for terminal block width: 5.2 mm, lettering field size: 4.4 x 4.7 mm, Number of individual labels: 72

Test plugs

Test plugs - MPS-MT - 0201744

<https://www.phoenixcontact.com/pc/products/0201744>



Test plugs, with solder connection up to 1 mm² conductor cross section, color: gray

Plug - PP-H 2,5/1-R GNYE

3210143

<https://www.phoenixcontact.com/pc/products/3210143>



Shield connection clamp

Shield connection clamp - PSH 3- 6 - 3040591

<https://www.phoenixcontact.com/pc/products/3040591>



Shield connection clamp, color: black

Shield connection clamp

Shield connection clamp - PSH 5-10 - 3040601

<https://www.phoenixcontact.com/pc/products/3040601>



Shield connection clamp, color: black

Phoenix Contact 2022 © - all rights reserved
<https://www.phoenixcontact.com>

PHOENIX CONTACT GmbH & Co. KG
Flachsmarktstraße 8
D-32825 Blomberg
+49 (0) 5235-3 00
info@phoenixcontact.com