

Relay Module - RIF-1-RPT-LDP-24DC/2X21



2903334

<https://www.phoenixcontact.com/de/produkte/2903334>

Please be informed that the data shown in this PDF document is generated from our Online Catalog. Please find the complete data in the user documentation. Our General Terms of Use for Downloads are valid.



Pre-assembled relay module with Push-in connection, consisting of: relay base, power contact relay, plug-in display/interference suppression module, and retaining bracket. Contact type: 2 changeover contacts. Input voltage: 24 V DC

Product Description

The pluggable electromechanical and solid-state relays in the RIFLINE complete product range and the base are recognized and approved in accordance with UL 508. The relevant approvals can be called up at the individual components in question.

Relay Module - RIF-1-RPT-LDP-24DC/2X21



2903334

<https://www.phoenixcontact.com/de/produkte/2903334>

Commercial Data

Item number	2903334
Packing unit	10 pc
Minimum order quantity	1 pc
Note	Made to Order (non-returnable)
Sales Key	G1 - Relais
Product Key	CK6529
Catalog Page	Page 327 (C-5-2019)
GTIN	4046356732277
Weight per Piece (including packing)	69,38 g
Weight per Piece (excluding packing)	64 g
Customs tariff number	85364110
Country of origin	CN

Relay Module - RIF-1-RPT-LDP-24DC/2X21



2903334

<https://www.phoenixcontact.com/de/produkte/2903334>

Set consists of

Relay base

Relay base - RIF-1-BPT/2X21 - 2900931

<https://www.phoenixcontact.com/de/produkte/2900931>



Relay base RIF-1..., for miniature power relay with 1 or 2 changeover contacts or solid-state relays of the same design, Push-in connection, plug-in option for input/interference suppression modules, for mounting on NS 35/7,5

Single relay

Single relay - REL-MR- 24DC/21-21 - 2961192

<https://www.phoenixcontact.com/de/produkte/2961192>

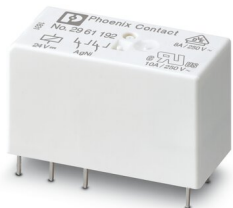

Plug-in miniature power relay, with power contact, 2 changeover contacts, input voltage 24 V DC

Relay Module - RIF-1-RPT-LDP-24DC/2X21

2903334

<https://www.phoenixcontact.com/de/produkte/2903334>

Plug-in module

Plug-in module - RIF-LDP-12-24 DC - 2900939

<https://www.phoenixcontact.com/de/produkte/2900939>



Plug-in module, for mounting on RIF-1, RIF-2, RIF-3, and RIF-4, with freewheeling diode and yellow LED, polarity: A1+, A2-, input voltage: 12 V DC ... 24 V DC $\pm 30\%$

Retaining bracket

Retaining bracket - RIF-RH-1 - 2900953

<https://www.phoenixcontact.com/de/produkte/2900953>



Relay retaining bracket, with ejector function and holder for marking material, suitable for RIF-1 relay base, for 16 mm tall miniature power relay and solid-state relay

Technical Data

Notes

Notes on operation	FBS 2-6... plug-in bridge for the input side (A2) and FBS-2-8... plug-in bridge for the output side (11/21)
Utilization restriction	
EMC note	EMC: class A product, see manufacturer's declaration in the download area

Product properties

Product type	Relay Module
Application	Universal
Operating mode	100% operating factor
Mechanical service life	approx. 3×10^7 cycles
Insulation characteristics	
Overvoltage category	III
Pollution degree	2
Insulation	Safe isolation between input and output Basic insulation between the changeover contacts

Electrical properties

Service life electrical	see diagram
Maximum power dissipation for nominal condition	0.43 W
Test voltage	4 kV _{rms} (50 Hz, 1 min., winding/contact)
Test voltage Changeover contact/changeover contact	2.5 kV _{rms} (50 Hz, 1 min., changeover contact/changeover contact)
Rated insulation voltage	250 V AC
Rated surge voltage	6 kV (Input/output) 4 kV (between the changeover contacts)

Input data

Coil side

Nominal input voltage U_N	24 V DC
Input voltage range	19.2 V DC ... 33.6 V DC (20 °C)
Input voltage range in reference to U_N	see diagram
Typical input current at U_N	18 mA
Typical response time	8 ms
Typical release time	10 ms
Coil voltage	24 V DC
Protective circuit	Freewheeling diode
Operating voltage display	Yellow LED

Output data

Relay Module - RIF-1-RPT-LDP-24DC/2X21



2903334

<https://www.phoenixcontact.com/de/produkte/2903334>

Switching

Contact type	2 changeover contacts
Type of switch contact	Single contact
Drive and function	monostable
Drive (polarity)	bipolar
Contact material	AgNi
Maximum switching voltage	250 V AC/DC
Minimum switching voltage	5 V (10 mA)
Limiting continuous current	8 A (see diagram)
Maximum inrush current	25 A (20 ms, N/O contacts)
Min. switching current	10 mA (5 V)
Interrupting rating (ohmic load) max.	192 W (at 24 V DC) 96 W (at 48 V DC) 60 W (at 60 V DC) 44 W (at 110 V DC) 57 W (at 220 V DC) 2000 VA (for 250 V AC)
Switching capacity	2 A (at 24 V, DC13) 0.2 A (at 250 V, DC13) 3 A (at 24 V, AC15) 3 A (at 120 V, AC15) 3 A (at 250 V, AC15)

Connection data

Connection method	Push-in connection
Stripping length	8 mm
Conductor cross section solid	0.14 mm ² ... 1.5 mm ²
Conductor cross section flexible	0.14 mm ² ... 1.5 mm ² 0.14 mm ² ... 1.5 mm ² (Ferrule with plastic sleeve) 0.14 mm ² ... 1 mm ² (Ferrule with plastic sleeve, two conductors on double terminal block)
Conductor cross section AWG	26 ... 16 (solid) 26 ... 16 (flexible)

Dimensions

Width	16 mm
Height	96 mm
Depth	75 mm
Hole diameter	3.2 mm

Material specifications

Flammability rating according to UL 94	V2 (Housing)
--	--------------

Environmental and real-life conditions

Relay Module - RIF-1-RPT-LDP-24DC/2X21



2903334

<https://www.phoenixcontact.com/de/produkte/2903334>

Ambient conditions

Degree of protection	IP20 (Relay base)
	RT III (Relay)
Ambient temperature (operation)	-40 °C ... 70 °C
Ambient temperature (storage/transport)	-40 °C ... 85 °C

Approval data

Corrosive gas test

Identification	ISA-S71.04. G3 Harsh Group
	EN 60068-2-60

Standards and regulations

Standards/regulations	DIN EN 50178
-----------------------	--------------

Mounting

Mounting type	DIN rail mounting
Assembly instructions	in rows with zero spacing
Mounting position	any

Drawings

Diagram

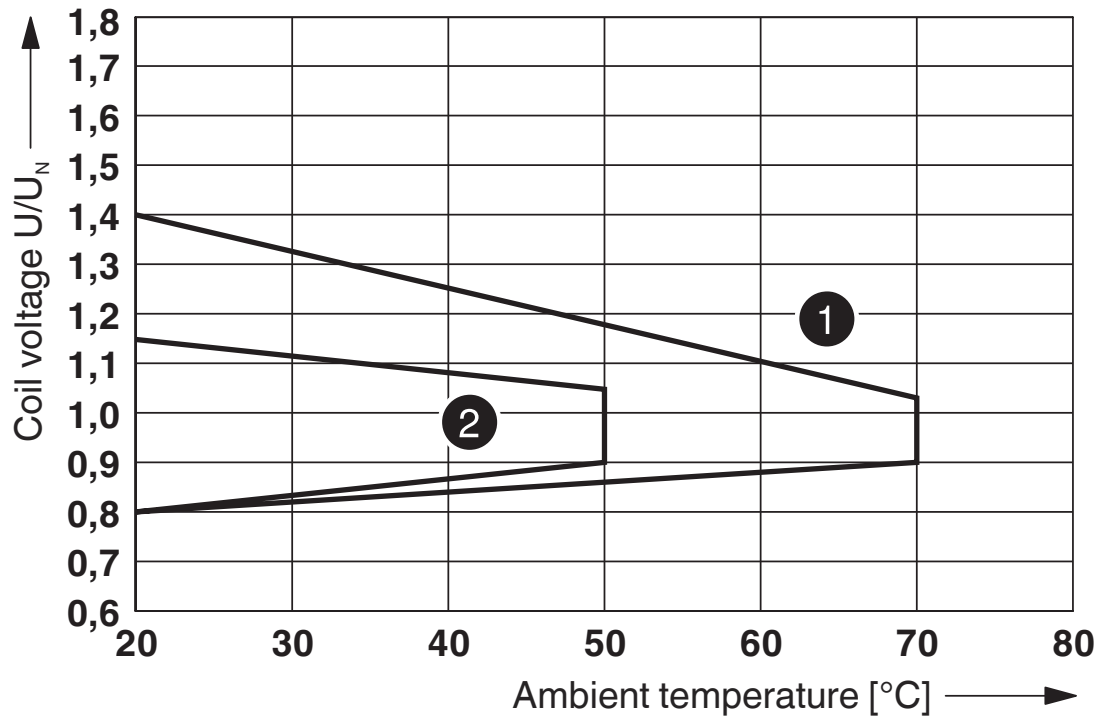

① DC coils

② AC coils

Operating voltage range

Diagram

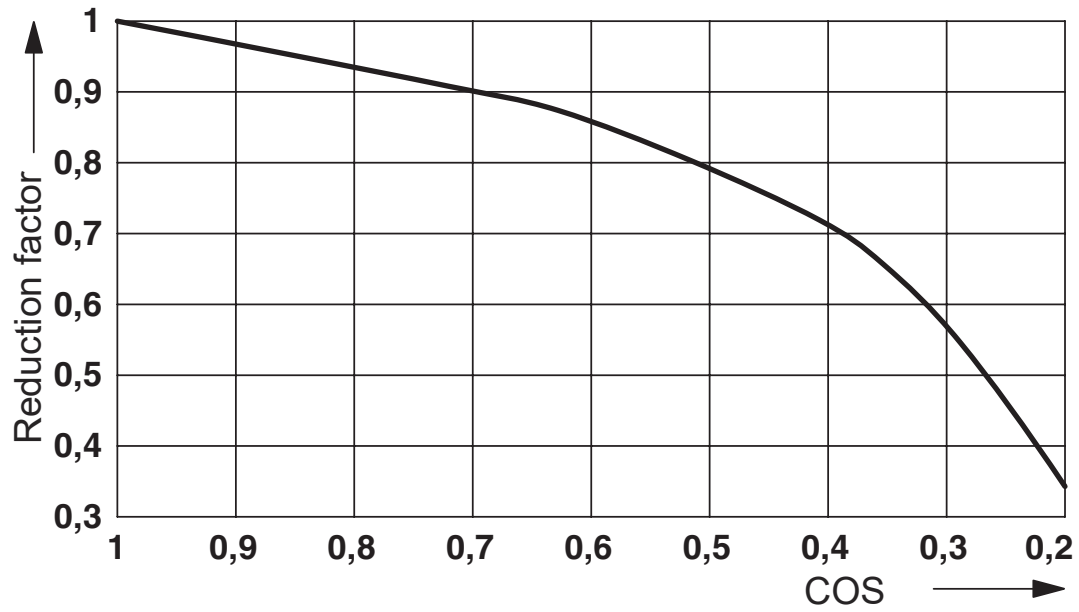

Service life reduction factor

Diagram

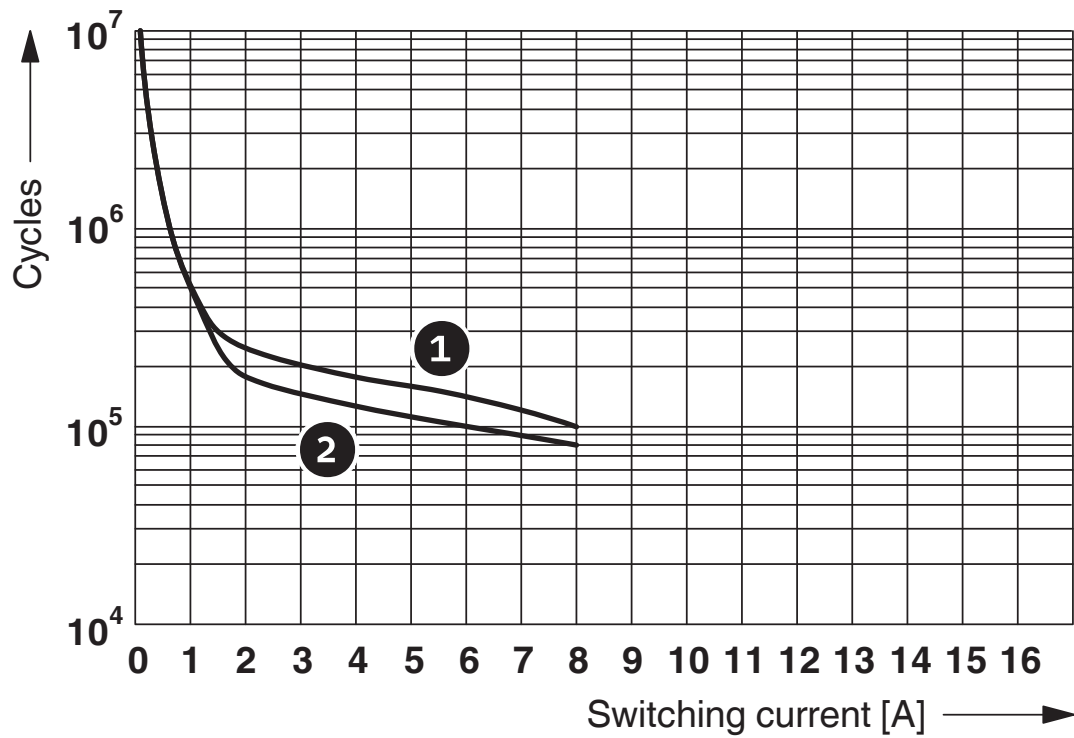

- ① 250 V AC, ohmic load (DC coils)
- ② 250 V AC, ohmic load (AC coils)

Electrical service life

Relay Module - RIF-1-RPT-LDP-24DC/2X21

2903334

<https://www.phoenixcontact.com/de/produkte/2903334>

Circuit diagram

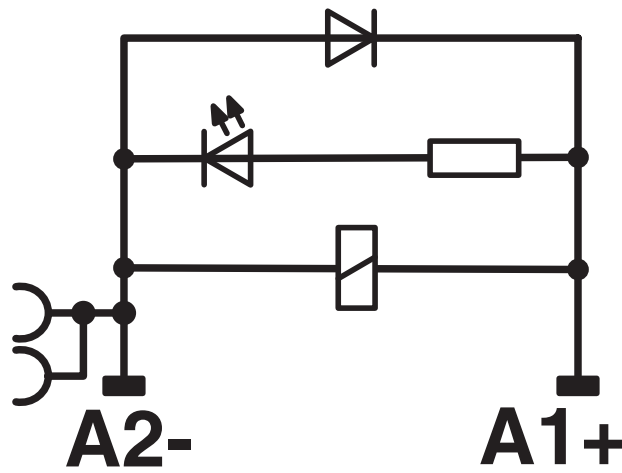
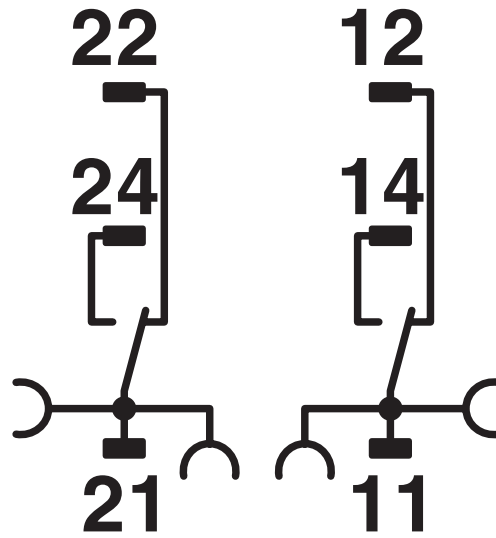

DC coils

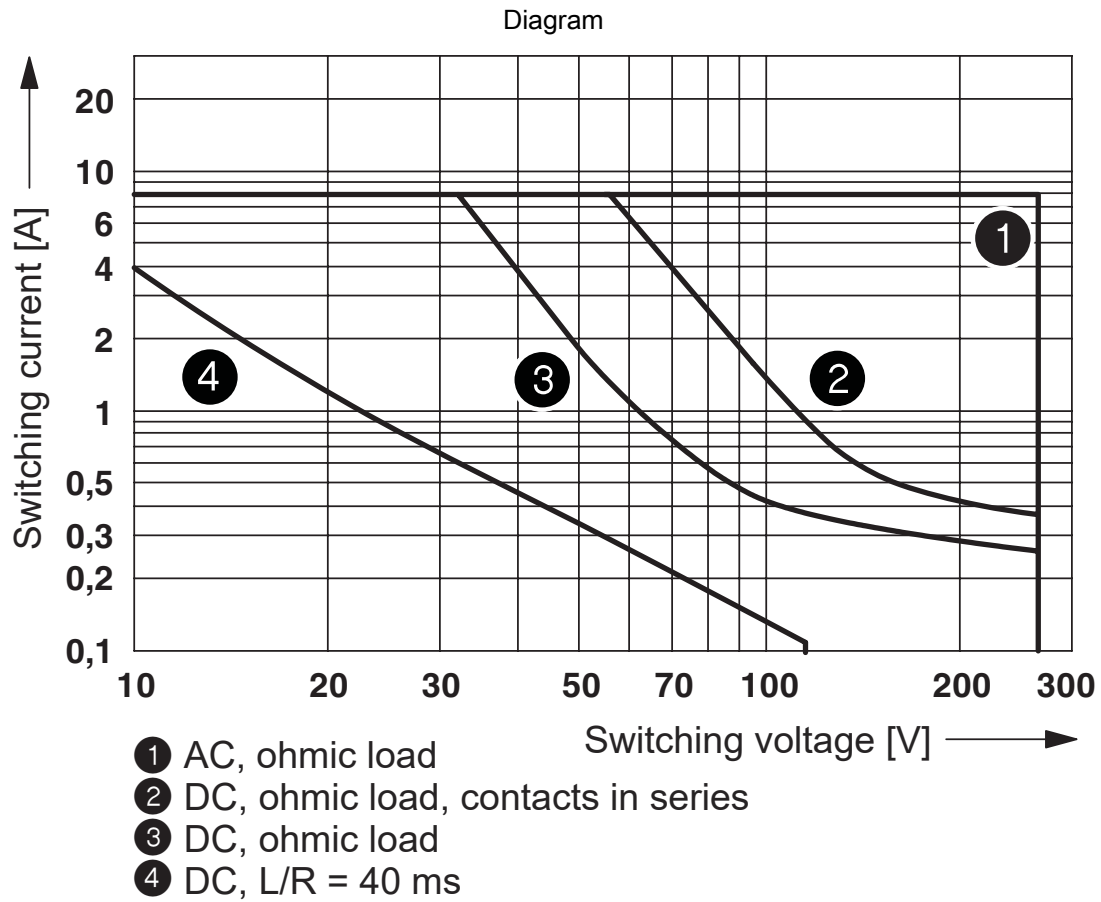

Interrupting rating

Diagram

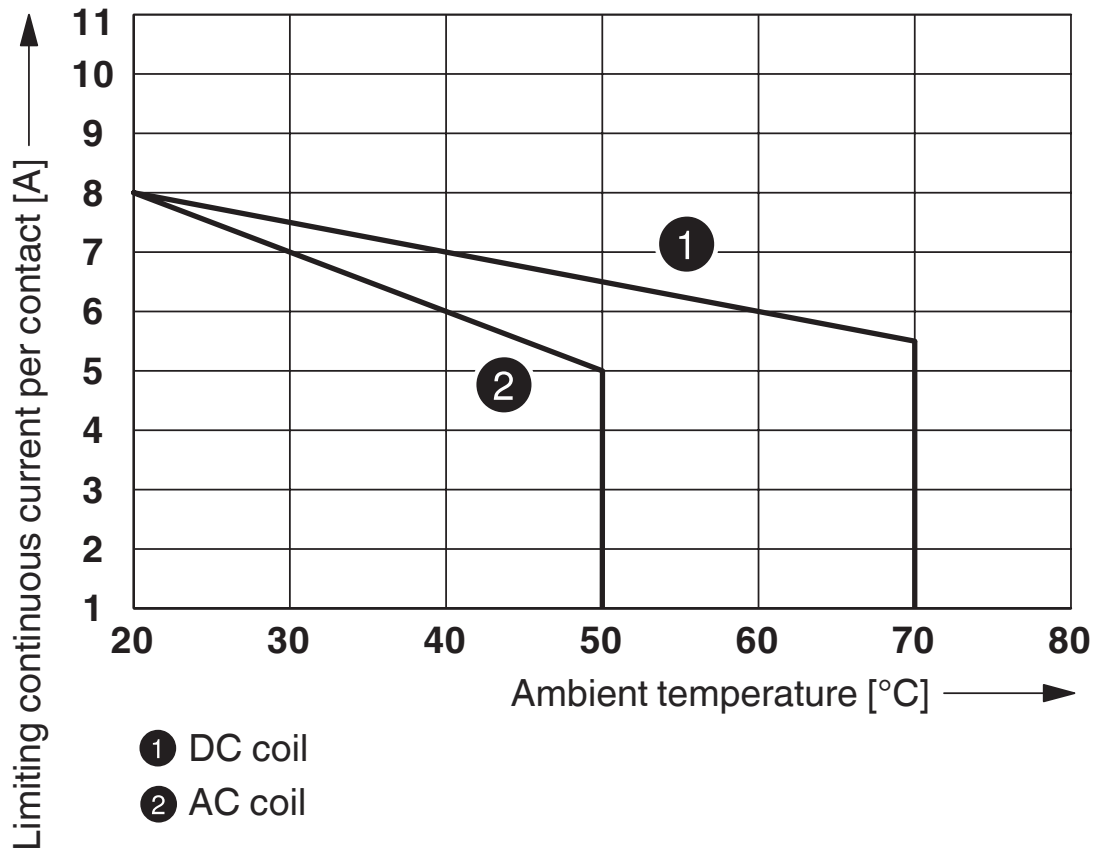

Contact derating

Relay Module - RIF-1-RPT-LDP-24DC/2X21



2903334

<https://www.phoenixcontact.com/de/produkte/2903334>

Approvals



EAC

Approval ID: TR_TS_D_00573_c



DNV GL

Approval ID: TAA000018V



DNV GL

Approval ID: TAA000018V

Relay Module - RIF-1-RPT-LDP-24DC/2X21



2903334

<https://www.phoenixcontact.com/de/produkte/2903334>

Classifications

ECLASS

ECLASS-9.0	27371601
ECLASS-10.0.1	27371601
ECLASS-11.0	27371601

ETIM

ETIM 8.0	EC001437
----------	----------

UNSPSC

UNSPSC 21.0	39122300
-------------	----------

Relay Module - RIF-1-RPT-LDP-24DC/2X21



2903334

<https://www.phoenixcontact.com/de/produkte/2903334>

Environmental Product Compliance

China RoHS	Environmentally Friendly Use Period = 50 years For information on hazardous substances, refer to the manufacturer's declaration available under "Downloads"
------------	--

Relay Module - RIF-1-RPT-LDP-24DC/2X21



2903334

<https://www.phoenixcontact.com/de/produkte/2903334>

Accessories

Plug-in bridge

Plug-in bridge - FBS 2-6 - 3030336

<https://www.phoenixcontact.com/de/produkte/3030336>



Plug-in bridge, pitch: 6.2 mm, color: red

DIN rail perforated

DIN rail perforated - NS 35/ 7,5 PERF 2000MM - 0801733

<https://www.phoenixcontact.com/de/produkte/0801733>



DIN rail perforated, acc. to EN 60715, material: Steel, galvanized, passivated with a thick layer, Standard profile, color: silver, Pack of 25 (50 m)

Relay Module - RIF-1-RPT-LDP-24DC/2X21

2903334

<https://www.phoenixcontact.com/de/produkte/2903334>

Plug-in bridge

Plug-in bridge - FBS 2-6 BU - 3036932

<https://www.phoenixcontact.com/de/produkte/3036932>



Plug-in bridge, pitch: 6.2 mm, color: blue

DIN rail, unperforated

DIN rail, unperforated - NS 35/ 7,5 UNPERF 2000MM - 0801681

<https://www.phoenixcontact.com/de/produkte/0801681>



DIN rail, unperforated, acc. to EN 60715, material: Steel, galvanized, passivated with a thick layer, Standard profile, color: silver, Pack of 25 (50 m)

Relay Module - RIF-1-RPT-LDP-24DC/2X21

2903334

<https://www.phoenixcontact.com/de/produkte/2903334>

Plug-in bridge

Plug-in bridge - FBS 2-6 GY - 3032237

<https://www.phoenixcontact.com/de/produkte/3032237>



Plug-in bridge, pitch: 6.2 mm, color: gray

DIN rail perforated

DIN rail perforated - NS 35/ 7,5 WH PERF 2000MM - 1204119

<https://www.phoenixcontact.com/de/produkte/1204119>



DIN rail perforated, acc. to EN 60715, material: Steel, Galvanized, white passivated, Standard profile, color: silver, Pack of 25 (50 m)

Relay Module - RIF-1-RPT-LDP-24DC/2X21

2903334

<https://www.phoenixcontact.com/de/produkte/2903334>

Plug-in bridge

Plug-in bridge - FBS 2-8 - 3030284

<https://www.phoenixcontact.com/de/produkte/3030284>

Plug-in bridge, pitch: 8.2 mm, color: red



DIN rail, unperforated

DIN rail, unperforated - NS 35/ 7,5 WH UNPERF 2000MM-VPE 10 - 1204122

<https://www.phoenixcontact.com/de/produkte/1204122>

DIN rail, unperforated, acc. to EN 60715, material: Steel, Galvanized, white passivated, Standard profile, color: silver, Pack of 10 (20 m)



Relay Module - RIF-1-RPT-LDP-24DC/2X21

2903334

<https://www.phoenixcontact.com/de/produkte/2903334>

Plug-in bridge

Plug-in bridge - FBS 2-8 BU - 3032567

<https://www.phoenixcontact.com/de/produkte/3032567>



Plug-in bridge, pitch: 8.2 mm, color: blue

DIN rail, unperforated

DIN rail, unperforated - NS 35/ 7,5 AL UNPERF 2000MM - 0801704

<https://www.phoenixcontact.com/de/produkte/0801704>



DIN rail, unperforated, acc. to EN 60715, material: Aluminum, uncoated, Standard profile, color: silver, Pack of 25 (50 m)

Relay Module - RIF-1-RPT-LDP-24DC/2X21



2903334

<https://www.phoenixcontact.com/de/produkte/2903334>

Plug-in bridge

Plug-in bridge - FBS 2-8 GY 7042 - 3032541

<https://www.phoenixcontact.com/de/produkte/3032541>



Bridge for potential distribution

DIN rail perforated

DIN rail perforated - NS 35/ 7,5 ZN PERF 2000MM - 1206421

<https://www.phoenixcontact.com/de/produkte/1206421>



DIN rail perforated, acc. to EN 60715, material: Steel, galvanized, Standard profile, color: silver, Pack of 25 (50 m)

Relay Module - RIF-1-RPT-LDP-24DC/2X21



2903334

<https://www.phoenixcontact.com/de/produkte/2903334>

Marker carriers

Marker carriers - STP 5-2 - 0800967

<https://www.phoenixcontact.com/de/produkte/0800967>



Double marker carrier, snaps onto the double-level spring-cage terminal block STTB 2,5, STTB 4, PTTB 2,5, PTTB 4 can be marked with UC-TM 5, ZB 5 or UC-TMF 5, ZBF 5

DIN rail, unperforated

DIN rail, unperforated - NS 35/ 7,5 ZN UNPERF 2000MM - 1206434

<https://www.phoenixcontact.com/de/produkte/1206434>



DIN rail, unperforated, acc. to EN 60715, material: Steel, galvanized, Standard profile, color: silver, Pack of 25 (50 m)

Relay Module - RIF-1-RPT-LDP-24DC/2X21

2903334

<https://www.phoenixcontact.com/de/produkte/2903334>

Marker for terminal blocks

Marker for terminal blocks - UC-TM 16 - 0819217

<https://www.phoenixcontact.com/de/produkte/0819217>



Marker for terminal blocks, Sheet, white, unlabeled, can be labeled with: BLUEMARK ID COLOR, BLUEMARK ID, BLUEMARK CLED, PLOTMARK, CMS-P1-PLOTTER, mounting type: snapped, for terminal block width: 16 mm, lettering field size: 15.45 x 10.5 mm, Number of individual labels: 32

DIN rail, unperforated

DIN rail, unperforated - NS 35/ 7,5 CU UNPERF 2000MM-VPE 10 - 0801762

<https://www.phoenixcontact.com/de/produkte/0801762>



DIN rail, unperforated, acc. to EN 60715, material: Copper, uncoated, Standard profile, color: copper-colored, Pack of 10 (20 m)

Relay Module - RIF-1-RPT-LDP-24DC/2X21

2903334

<https://www.phoenixcontact.com/de/produkte/2903334>

Marker for terminal blocks

Marker for terminal blocks - UC-TMF 16 - 0819262

<https://www.phoenixcontact.com/de/produkte/0819262>



Marker for terminal blocks, Sheet, white, unlabeled, can be labeled with: BLUEMARK ID COLOR, BLUEMARK ID, BLUEMARK CLED, PLOTMARK, CMS-P1-PLOTTER, mounting type: snapped, for terminal block width: 16 mm, lettering field size: 15.45 x 5.1 mm, Number of individual labels: 32

End cap

End cap - NS 35/ 7,5 CAP - 1206560

<https://www.phoenixcontact.com/de/produkte/1206560>

DIN rail end piece, for DIN rail NS 35/7.5



Relay Module - RIF-1-RPT-LDP-24DC/2X21

2903334

<https://www.phoenixcontact.com/de/produkte/2903334>

DIN rail perforated

DIN rail perforated - NS 35/15 PERF 2000MM - 1201730

<https://www.phoenixcontact.com/de/produkte/1201730>



DIN rail perforated, similar to EN 60715, material: Steel, galvanized, passivated with a thick layer, Standard profile, color: silver, Pack of 25 (50 m)

DIN rail, unperforated

DIN rail, unperforated - NS 35/15 UNPERF 2000MM - 1201714

<https://www.phoenixcontact.com/de/produkte/1201714>



DIN rail, unperforated, similar to EN 60715, material: Steel, galvanized, passivated with a thick layer, Standard profile, color: silver, Pack of 25 (50 m)

Relay Module - RIF-1-RPT-LDP-24DC/2X21

2903334

<https://www.phoenixcontact.com/de/produkte/2903334>

DIN rail perforated

DIN rail perforated - NS 35/15 WH PERF 2000MM - 0806602

<https://www.phoenixcontact.com/de/produkte/0806602>



DIN rail perforated, similar to EN 60715, material: Steel, Galvanized, white passivated, Standard profile, color: white, Pack of 25 (50 m)

DIN rail, unperforated

DIN rail, unperforated - NS 35/15 WH UNPERF 2000MM-VPE 10 - 1204135

<https://www.phoenixcontact.com/de/produkte/1204135>



DIN rail, unperforated, similar to EN 60715, material: Steel, Galvanized, white passivated, Standard profile, color: silver, Pack of 10 (20 m)

Relay Module - RIF-1-RPT-LDP-24DC/2X21

2903334

<https://www.phoenixcontact.com/de/produkte/2903334>

DIN rail, unperforated

DIN rail, unperforated - NS 35/15 AL UNPERF 2000MM - 1201756

<https://www.phoenixcontact.com/de/produkte/1201756>



DIN rail, unperforated, similar to EN 60715, material: Aluminum, uncoated, Standard profile, color: silver

DIN rail perforated

DIN rail perforated - NS 35/15 ZN PERF 2000MM - 1206599

<https://www.phoenixcontact.com/de/produkte/1206599>



DIN rail perforated, similar to EN 60715, material: Steel, galvanized, Standard profile, color: silver, Pack of 25 (50 m)

Relay Module - RIF-1-RPT-LDP-24DC/2X21

2903334

<https://www.phoenixcontact.com/de/produkte/2903334>

DIN rail, unperforated

DIN rail, unperforated - NS 35/15 ZN UNPERF 2000MM - 1206586

<https://www.phoenixcontact.com/de/produkte/1206586>



DIN rail, unperforated, similar to EN 60715, material: Steel, galvanized, Standard profile, color: silver, Pack of 25 (50 m)

DIN rail, unperforated

DIN rail, unperforated - NS 35/15 CU UNPERF 2000MM-VPE 10 - 1201895

<https://www.phoenixcontact.com/de/produkte/1201895>



DIN rail, unperforated, similar to EN 60715, material: Copper, uncoated, Standard profile, color: copper-colored, Pack of 10 (20 m)

Relay Module - RIF-1-RPT-LDP-24DC/2X21

2903334

<https://www.phoenixcontact.com/de/produkte/2903334>

End cap

End cap - NS 35/15 CAP - 1206573

<https://www.phoenixcontact.com/de/produkte/1206573>

DIN rail end piece, for DIN rail NS 35/15



DIN rail, unperforated

DIN rail, unperforated - NS 35/15-2,3 UNPERF 2000MM-VPE 10 - 1201798

<https://www.phoenixcontact.com/de/produkte/1201798>



DIN rail, unperforated, acc. to EN 60715, material: Steel, galvanized, passivated with a thick layer, Standard profile 2.3 mm, color: silver, Pack of 10 (20 m)

Relay Module - RIF-1-RPT-LDP-24DC/2X21

2903334

<https://www.phoenixcontact.com/de/produkte/2903334>

End clamp

End clamp - CLIPFIX 35 - 3022218

<https://www.phoenixcontact.com/de/produkte/3022218>



Quick mounting end clamp for NS 35/7,5 DIN rail or NS 35/15 DIN rail, with marking option, width: 9.5 mm, color: gray

End clamp

End clamp - CLIPFIX 35-5 - 3022276

<https://www.phoenixcontact.com/de/produkte/3022276>



Quick mounting end clamp for NS 35/7,5 DIN rail or NS 35/15 DIN rail, with marking option, with parking option for FBS...5, FBS...6, KSS 5, KSS 6, width: 5.15 mm, color: gray

Relay Module - RIF-1-RPT-LDP-24DC/2X21

2903334

<https://www.phoenixcontact.com/de/produkte/2903334>

End clamp

End clamp - E/NS 35 N - 0800886

<https://www.phoenixcontact.com/de/produkte/0800886>

End clamp, width: 9.5 mm, color: gray

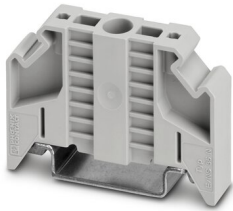

Test plugs

Test plugs - MPS-MT - 0201744

<https://www.phoenixcontact.com/de/produkte/0201744>

Test plugs, with solder connection up to 1 mm² conductor cross section, color: gray



Relay Module - RIF-1-RPT-LDP-24DC/2X21

2903334

<https://www.phoenixcontact.com/de/produkte/2903334>

Insulating sleeve

Insulating sleeve - MPS-IH WH - 0201663

<https://www.phoenixcontact.com/de/produkte/0201663>

Insulating sleeve, color: white



Insulating sleeve

Insulating sleeve - MPS-IH RD - 0201676

<https://www.phoenixcontact.com/de/produkte/0201676>

Insulating sleeve, color: red



Relay Module - RIF-1-RPT-LDP-24DC/2X21

2903334

<https://www.phoenixcontact.com/de/produkte/2903334>

Insulating sleeve

Insulating sleeve - MPS-IH BU - 0201689

<https://www.phoenixcontact.com/de/produkte/0201689>

Insulating sleeve, color: blue

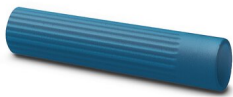

Insulating sleeve

Insulating sleeve - MPS-IH YE - 0201692

<https://www.phoenixcontact.com/de/produkte/0201692>

Insulating sleeve, color: yellow



Relay Module - RIF-1-RPT-LDP-24DC/2X21

2903334

<https://www.phoenixcontact.com/de/produkte/2903334>

Insulating sleeve

Insulating sleeve - MPS-IH GN - 0201702

<https://www.phoenixcontact.com/de/produkte/0201702>

Insulating sleeve, color: green



Insulating sleeve

Insulating sleeve - MPS-IH GY - 0201728

<https://www.phoenixcontact.com/de/produkte/0201728>

Insulating sleeve, color: gray



Relay Module - RIF-1-RPT-LDP-24DC/2X21

2903334

<https://www.phoenixcontact.com/de/produkte/2903334>

Insulating sleeve

Insulating sleeve - MPS-IH BK - 0201731

<https://www.phoenixcontact.com/de/produkte/0201731>

Insulating sleeve, color: black



Zack marker strip

Zack marker strip - ZB 5 :UNBEDRUCKT - 1050004

<https://www.phoenixcontact.com/de/produkte/1050004>



Zack marker strip, Strip, white, unlabeled, can be labeled with: PLOTMARK, CMS-P1-PLOTTER, mounting type: snapped, for terminal block width: 5.2 mm, lettering field size: 5.1 x 10.5 mm, Number of individual labels: 10

Relay Module - RIF-1-RPT-LDP-24DC/2X21

2903334

<https://www.phoenixcontact.com/de/produkte/2903334>

Zack marker strip

Zack marker strip - ZB 5 CUS - 0824962

<https://www.phoenixcontact.com/de/produkte/0824962>

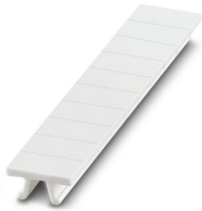

Zack marker strip, can be ordered: Strip, white, labeled according to customer specifications, mounting type: snap into tall marker groove, for terminal block width: 5.2 mm, lettering field size: 5.15 x 10.5 mm, Number of individual labels: 10

Zack marker strip

Zack marker strip - ZB 5,LGS:FORTL.ZAHLEN - 1050017

<https://www.phoenixcontact.com/de/produkte/1050017>



Zack marker strip, Strip, white, labeled, printed horizontally: consecutive numbers 1 ... 10, 11 ... 20, etc. up to 491 ... 500, mounting type: snapped, for terminal block width: 5.2 mm, lettering field size: 5.15 x 10.5 mm, Number of individual labels: 10

Relay Module - RIF-1-RPT-LDP-24DC/2X21

2903334

<https://www.phoenixcontact.com/de/produkte/2903334>

Zack marker strip

Zack marker strip - ZB 5,QR:FORTL.ZAHLEN - 1050020

<https://www.phoenixcontact.com/de/produkte/1050020>

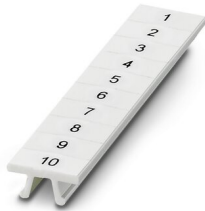

Zack marker strip, white, Printed vertically: consecutive numbers 1 ... 10, 11 ... 20, etc. up to 491 ... 500, mounting type: snapped, for terminal block width: 5.2 mm, lettering field size: 5.15 x 10.5 mm

Zack marker strip

Zack marker strip - ZB 5,LGS:GLEICHE ZAHLEN - 1050033

<https://www.phoenixcontact.com/de/produkte/1050033>



Zack marker strip, Strip, white, labeled, can be labeled with: CMS-P1-PLOTTER, printed horizontally: Identical numbers 1 or 2, etc. up to 100, mounting type: snapped, for terminal block width: 5.2 mm, lettering field size: 5.15 x 10.5 mm, Number of individual labels: 10

Relay Module - RIF-1-RPT-LDP-24DC/2X21

2903334

<https://www.phoenixcontact.com/de/produkte/2903334>

Zack marker strip

Zack marker strip - ZB 5,LGS:L1-N,PE - 1050415

<https://www.phoenixcontact.com/de/produkte/1050415>



Zack marker strip, Strip, white, labeled, horizontal: L1, L2, L3, N, PE, L1, L2, L3, N, PE, mounting type: snapped, for terminal block width: 5.2 mm, lettering field size: 5.15 x 10.5 mm, Number of individual labels: 10

Marker for terminal blocks

Marker for terminal blocks - UC-TM 5 - 0818108

<https://www.phoenixcontact.com/de/produkte/0818108>



Marker for terminal blocks, Sheet, white, unlabeled, can be labeled with: BLUEMARK ID COLOR, BLUEMARK ID, BLUEMARK CLED, PLOTMARK, CMS-P1-PLOTTER, mounting type: snapped, for terminal block width: 5.2 mm, lettering field size: 10.5 x 4.6 mm, Number of individual labels: 96

Relay Module - RIF-1-RPT-LDP-24DC/2X21

2903334

<https://www.phoenixcontact.com/de/produkte/2903334>

Marker for terminal blocks

Marker for terminal blocks - UC-TM 5 CUS - 0824581

<https://www.phoenixcontact.com/de/produkte/0824581>



Marker for terminal blocks, can be ordered: by sheet, white, labeled according to customer specifications, mounting type: snap into tall marker groove, for terminal block width: 5.2 mm, lettering field size: 10.5 x 4.6 mm, Number of individual labels: 96

Marker for terminal blocks

Marker for terminal blocks - UCT-TM 5 - 0828734

<https://www.phoenixcontact.com/de/produkte/0828734>



Marker for terminal blocks, Sheet, white, unlabeled, can be labeled with: TOPMARK NEO, TOPMARK LASER, BLUEMARK ID COLOR, BLUEMARK ID, BLUEMARK CLED, THERMOMARK PRIME, THERMOMARK CARD 2.0, THERMOMARK CARD, mounting type: snapped, for terminal block width: 5.2 mm, lettering field size: 4.6 x 10.5 mm, Number of individual labels: 72

Relay Module - RIF-1-RPT-LDP-24DC/2X21

2903334

<https://www.phoenixcontact.com/de/produkte/2903334>

Marker for terminal blocks

Marker for terminal blocks - UCT-TM 5 CUS - 0829595

<https://www.phoenixcontact.com/de/produkte/0829595>



Marker for terminal blocks, can be ordered: by sheet, white, labeled according to customer specifications, mounting type: snap into tall marker groove, for terminal block width: 5.2 mm, lettering field size: 4.6 x 10.5 mm, Number of individual labels: 72

Zack marker strip

Zack marker strip - ZB 15:UNBEDRUCKT - 0811972

<https://www.phoenixcontact.com/de/produkte/0811972>

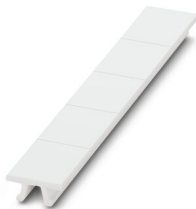

Zack marker strip, Strip, white, unlabeled, can be labeled with: PLOTMARK, CMS-P1-PLOTTER, mounting type: snapped, for terminal block width: 15.2 mm, lettering field size: 10.5 x 15.1 mm, Number of individual labels: 5

Relay Module - RIF-1-RPT-LDP-24DC/2X21

2903334

<https://www.phoenixcontact.com/de/produkte/2903334>

Zack marker strip

Zack marker strip - ZB 15 CUS - 0824945

<https://www.phoenixcontact.com/de/produkte/0824945>

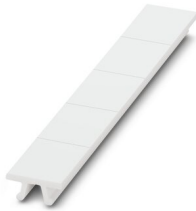

Zack marker strip, can be ordered: Strip, white, labeled according to customer specifications, mounting type: snap into tall marker groove, for terminal block width: 15.2 mm, lettering field size: 10.5 x 15.1 mm, Number of individual labels: 5

Zack marker strip

Zack marker strip - ZB 15,LGS:L1-N,PE - 0811998

<https://www.phoenixcontact.com/de/produkte/0811998>

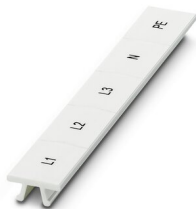

Zack marker strip, Strip, white, labeled, printed horizontally: L1, L2, L3, N, PE, mounting type: snapped, for terminal block width: 15.2 mm, lettering field size: 10.5 x 15.1 mm, Number of individual labels: 5

Relay Module - RIF-1-RPT-LDP-24DC/2X21

2903334

<https://www.phoenixcontact.com/de/produkte/2903334>

Relay base

Relay base - RIF-1-BPT/2X21 - 2900931

<https://www.phoenixcontact.com/de/produkte/2900931>



Relay base RIF-1..., for miniature power relay with 1 or 2 changeover contacts or solid-state relays of the same design, Push-in connection, plug-in option for input/interference suppression modules, for mounting on NS 35/7,5

Single relay

Single relay - REL-MR- 24DC/21-21 - 2961192

<https://www.phoenixcontact.com/de/produkte/2961192>

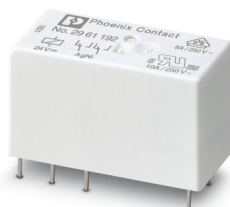

Plug-in miniature power relay, with power contact, 2 changeover contacts, input voltage 24 V DC

Relay Module - RIF-1-RPT-LDP-24DC/2X21



2903334

<https://www.phoenixcontact.com/de/produkte/2903334>

Plug-in module

Plug-in module - RIF-LDP-12-24 DC - 2900939

<https://www.phoenixcontact.com/de/produkte/2900939>



Plug-in module, for mounting on RIF-1, RIF-2, RIF-3, and RIF-4, with freewheeling diode and yellow LED, polarity: A1+, A2-, input voltage: 12 V DC ... 24 V DC $\pm 30\%$

Retaining bracket

Retaining bracket - RIF-RH-1 - 2900953

<https://www.phoenixcontact.com/de/produkte/2900953>



Relay retaining bracket, with ejector function and holder for marking material, suitable for RIF-1 relay base, for 16 mm tall miniature power relay and solid-state relay

Phoenix Contact 2022 © - all rights reserved
<https://www.phoenixcontact.com>

PHOENIX CONTACT Deutschland GmbH
Flachsmarktstraße 8
D-32825 Blomberg
+49 52 35/3-1 20 00
info@phoenixcontact.de