

# Plug - PP-H 1,5/S/1-M

3212688

<https://www.phoenixcontact.com/de/produkte/3212688>



Please be informed that the data shown in this PDF document is generated from our Online Catalog. Please find the complete data in the user documentation. Our General Terms of Use for Downloads are valid.

---



Plug, nom. voltage: 500 V, nominal current: 17.5 A, connection method: Push-in connection, 1 level, Rated cross section: 1.5 mm<sup>2</sup>, cross section: 0.14 mm<sup>2</sup> - 1.5 mm<sup>2</sup>, color: gray

---

## Product Description

Connector element center, left housing with engagement pin, right opened without cover

## Your advantages

- Large-surface labeling option
- The Push-in technology COMBI plugs for self-assembly provide solutions that users can implement themselves
- Tested for railway applications

# Plug - PP-H 1,5/S/1-M

3212688

<https://www.phoenixcontact.com/de/produkte/3212688>



## Commercial Data

Item number	3212688
Packing unit	50 pc
Minimum order quantity	50 pc
Sales Key	A1 - Reihenklennen
Product Key	BE2244
Catalog Page	Page 285 (C-1-2019)
GTIN	4046356565820
Weight per Piece (including packing)	1,91 g
Weight per Piece (excluding packing)	1,867 g
Customs tariff number	85366990
Country of origin	PL

## Technical Data

### Product properties

Product type	Terminal plug
Number of positions	1
Pitch	3.5 mm
Area of application	Railway industry
	Machine building
	Plant engineering
Number of connections	1
Number of rows	1
Type	other
Potentials	1

### Insulation characteristics

Overvoltage category	III
Degree of pollution	3

### Electrical properties

Rated surge voltage	6 kV
Maximum power dissipation for nominal condition	0.56 W

### Connection data

Number of connections per level	1
Nominal cross section	1.5 mm <sup>2</sup>

#### 1 level

Stripping length	8 mm ... 10 mm
Internal cylindrical gage	A1 / B1
Conductor cross section solid	0.14 mm <sup>2</sup> ... 1.5 mm <sup>2</sup>
Cross section AWG	26 ... 14
Conductor cross section flexible	0.14 mm <sup>2</sup> ... 1.5 mm <sup>2</sup>
Conductor cross section, flexible [AWG]	26 ... 14
Flexible conductor cross section flexible (ferrule, w/o plastic sleeve)	0.14 mm <sup>2</sup> ... 1.5 mm <sup>2</sup>
Flexible conductor cross section (ferrule with plastic sleeve)	0.14 mm <sup>2</sup> ... 1 mm <sup>2</sup>
Nominal current	17.5 A (observe derating)
Maximum load current	17.5 A (with 1.5 mm <sup>2</sup> conductor cross section)
Nominal voltage	500 V
Nominal cross section	1.5 mm <sup>2</sup>

#### 1 level Connection cross sections directly pluggable

Conductor cross section solid	0.25 mm <sup>2</sup> ... 1.5 mm <sup>2</sup>
Flexible conductor cross section flexible (ferrule, w/o plastic sleeve)	0.34 mm <sup>2</sup> ... 1.5 mm <sup>2</sup>

# Plug - PP-H 1,5/S/1-M



3212688

<https://www.phoenixcontact.com/de/produkte/3212688>

Flexible conductor cross section (ferrule with plastic sleeve)	0.34 mm <sup>2</sup> ... 1 mm <sup>2</sup>
--	--

## Dimensions

Width	3.5 mm
Height	31.3 mm
Length	16.5 mm
Pitch	3.5 mm

## Material specifications

Color	gray
Flammability rating according to UL 94	V0
Insulating material group	I
Insulating material	PA
Static insulating material application in cold	-60 °C
Temperature index of insulation material (DIN EN 60216-1 (VDE 0304-21))	130 °C
Relative insulation material temperature index (Elec., UL 746 B)	130 °C
Fire protection for rail vehicles (DIN EN 45545-2) R22	HL 1 - HL 3
Fire protection for rail vehicles (DIN EN 45545-2) R23	HL 1 - HL 3
Fire protection for rail vehicles (DIN EN 45545-2) R24	HL 1 - HL 3
Fire protection for rail vehicles (DIN EN 45545-2) R26	HL 1 - HL 3
Calorimetric heat release NFPA 130 (ASTM E 1354)	28 MJ/kg
Surface flammability NFPA 130 (ASTM E 162)	passed
Specific optical density of smoke NFPA 130 (ASTM E 662)	passed
Smoke gas toxicity NFPA 130 (SMP 800C)	passed

## Mechanical properties

### Mechanical data

Open side panel	Yes
-----------------	-----

## Environmental and real-life conditions

### Ambient conditions

Ambient temperature (operation)	-60 °C ... 105 °C (max. short-term operating temperature RTI Elec.)
Ambient temperature (storage/transport)	-25 °C ... 60 °C (for a short time, not exceeding 24 h, -60 °C to +70 °C)
Ambient temperature (assembly)	-5 °C ... 70 °C
Ambient temperature (actuation)	-5 °C ... 70 °C
Permissible humidity (storage/transport)	30 % ... 70 %

## Standards and regulations

Connection in acc. with standard	IEC 61984
----------------------------------	-----------

## Mounting

Assembly instructions	Use of a parallel pressing tool is recommended for easy latching
-----------------------	--

# Plug - PP-H 1,5/S/1-M

3212688

<https://www.phoenixcontact.com/de/produkte/3212688>



of the COMBI connector and coupling elements for self-assembly

## Drawings

### Circuit diagram



### Diagram

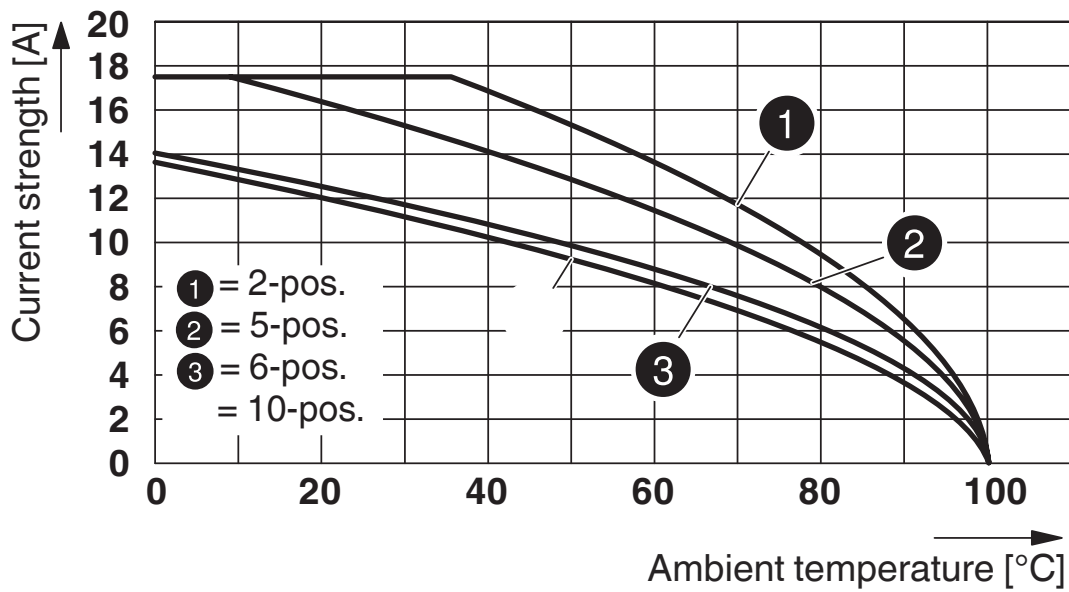

# Plug - PP-H 1,5/S/1-M

3212688

<https://www.phoenixcontact.com/de/produkte/3212688>

Schematic diagram

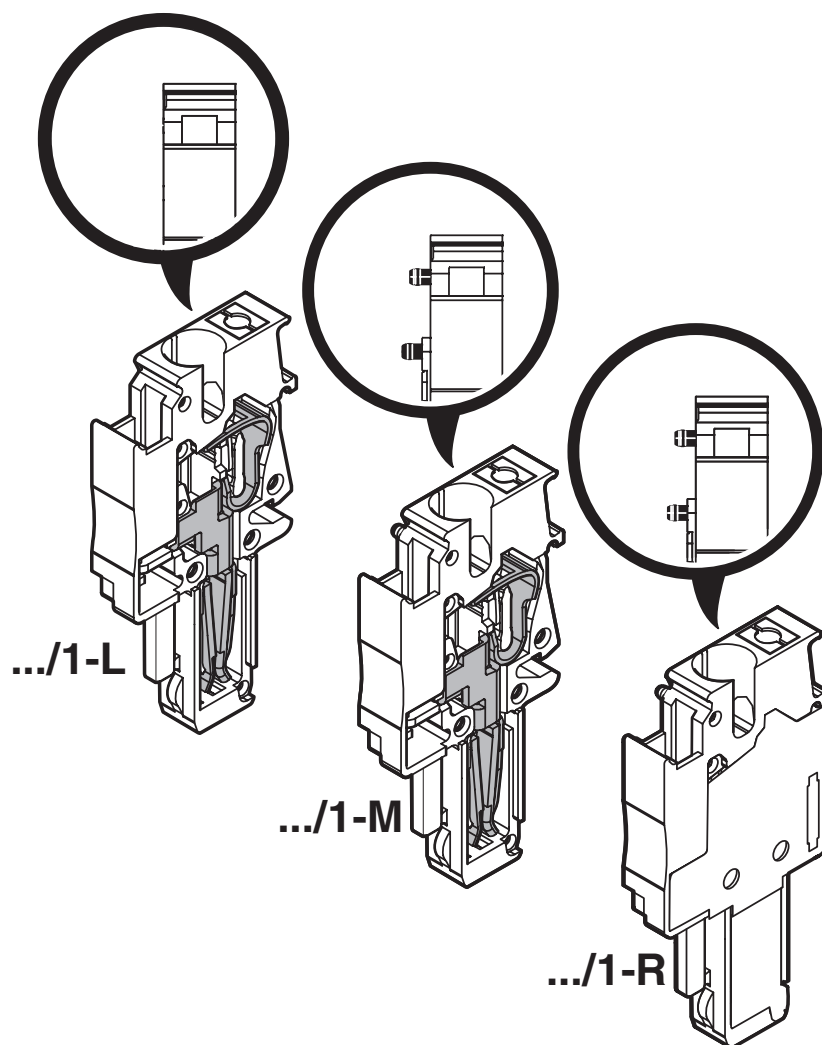

# Plug - PP-H 1,5/S/1-M



3212688

<https://www.phoenixcontact.com/de/produkte/3212688>

## Approvals

### DNV

Approval ID: TAE00003JE



### CSA

Approval ID: 13631

	Nominal Voltage $U_N$	Nominal Current $I_N$	Cross Section AWG	Cross Section $\text{mm}^2$
Use group B	300 V	15 A	26 - 14	-
Use group C	300 V	15 A	26 - 14	-
Use group D	600 V	5 A	26 - 14	-



### IECEE CB Scheme

Approval ID: DE1-65179

	Nominal Voltage $U_N$	Nominal Current $I_N$	Cross Section AWG	Cross Section $\text{mm}^2$
	500 V		-	0.14 - 1.5



### EAC

Approval ID: RU C-DE.BL08.B.00511



### cULus Recognized

Approval ID: E60425

	Nominal Voltage $U_N$	Nominal Current $I_N$	Cross Section AWG	Cross Section $\text{mm}^2$
Use group B	300 V	15 A	26 - 14	-
Use group C	300 V	15 A	26 - 14	-
Use group D	600 V	5 A	26 - 14	-



### LR

Approval ID: 12/20038 (E3)



### NK

Approval ID: 14ME0912



# Plug - PP-H 1,5/S/1-M



3212688

<https://www.phoenixcontact.com/de/produkte/3212688>



**BV**

Approval ID: 39979/B0 BV



**VDE Gutachten mit Fertigungsüberwachung**

Approval ID: 40034766

	Nominal Voltage $U_N$	Nominal Current $I_N$	Cross Section AWG	Cross Section $\text{mm}^2$
	500 V		-	0.14 - 1.5

# Plug - PP-H 1,5/S/1-M

3212688

<https://www.phoenixcontact.com/de/produkte/3212688>



## Classifications

### ECLASS

ECLASS-9.0	27141151
ECLASS-10.0.1	27141151
ECLASS-11.0	27141151

### ETIM

ETIM 8.0	EC002021
----------	----------

### UNSPSC

UNSPSC 21.0	39121400
-------------	----------

# Plug - PP-H 1,5/S/1-M

3212688

<https://www.phoenixcontact.com/de/produkte/3212688>



## Environmental Product Compliance

China RoHS	Environmentally friendly use period: unlimited = EFUP-e
	No hazardous substances above threshold values

# Plug - PP-H 1,5/S/1-M

3212688

<https://www.phoenixcontact.com/de/produkte/3212688>



## Accessories

### Latching

Latching - PR 1,5/S - 3212882

<https://www.phoenixcontact.com/de/produkte/3212882>



Latching, length: 28.9 mm, width: 3.3 mm, number of positions: 1, color: orange

---

### Zack Marker strip, flat

Zack Marker strip, flat - ZBF 3,5:UNBEDRUCKT - 0829392

<https://www.phoenixcontact.com/de/produkte/0829392>



Zack Marker strip, flat, Strip, white, unlabeled, can be labeled with: PLOTMARK, CMS-P1-PLOTTER, mounting type: snapped, for terminal block width: 3.5 mm, lettering field size: 3.5 x 5.2 mm, Number of individual labels: 10

# Plug - PP-H 1,5/S/1-M

3212688

<https://www.phoenixcontact.com/de/produkte/3212688>



## Latching

Latching - PR 1,5/S/2 - 3212895

<https://www.phoenixcontact.com/de/produkte/3212895>



Latching, length: 28.9 mm, width: 6.8 mm, number of positions: 2, color: orange

---

## Zack Marker strip, flat

Zack Marker strip, flat - ZBF 3,5 CUS - 0829394

<https://www.phoenixcontact.com/de/produkte/0829394>

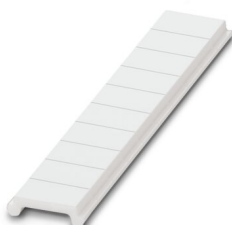

Zack Marker strip, flat, can be ordered: Strip, white, labeled according to customer specifications, mounting type: snap into flat marker groove, for terminal block width: 3.5 mm, lettering field size: 3.5 x 5.2 mm, Number of individual labels: 10

# Plug - PP-H 1,5/S/1-M

3212688

<https://www.phoenixcontact.com/de/produkte/3212688>



## Latching

Latching - PRZ 1,5/S - 3212905

<https://www.phoenixcontact.com/de/produkte/3212905>



Latching, color: orange

---

## Zack Marker strip, flat

Zack Marker strip, flat - ZBF 3,5,LGS:FORTL.ZAHLEN - 0801406

<https://www.phoenixcontact.com/de/produkte/0801406>



Zack Marker strip, flat, Strip, white, labeled, printed horizontally: consecutive numbers 1 ... 10, 11 ... 20, etc. up to 91 ... 100, mounting type: snapped, for terminal block width: 3.5 mm, lettering field size: 5.15 x 3.5 mm, Number of individual labels: 10

# Plug - PP-H 1,5/S/1-M

3212688

<https://www.phoenixcontact.com/de/produkte/3212688>



## Strain relief

Strain relief - PZ 1,5/S/2 - 3212918

<https://www.phoenixcontact.com/de/produkte/3212918>



Strain relief, length: 44.5 mm, width: 6.8 mm, number of positions: 2, color: black

---

## Zack Marker strip, flat

Zack Marker strip, flat - ZBF 3,5,QR:FORTL.ZAHLEN - 0801407

<https://www.phoenixcontact.com/de/produkte/0801407>

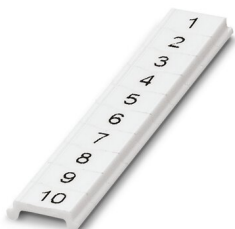

Zack Marker strip, flat, Strip, white, labeled, Printed vertically: consecutive numbers 1 ... 10, 11 ... 20, etc. up to 91 ... 100, mounting type: snapped, for terminal block width: 3.5 mm, lettering field size: 5.15 x 3.5 mm, Number of individual labels: 10

# Plug - PP-H 1,5/S/1-M

3212688

<https://www.phoenixcontact.com/de/produkte/3212688>



## Shield connection clamp

Shield connection clamp - PSH 3- 6 - 3040591

<https://www.phoenixcontact.com/de/produkte/3040591>



Shield connection clamp, color: black

---

## Marker for terminal blocks

Marker for terminal blocks - UCT-TMF 3,5 - 0829486

<https://www.phoenixcontact.com/de/produkte/0829486>



Marker for terminal blocks, Sheet, white, unlabeled, can be labeled with: TOPMARK NEO, TOPMARK LASER, BLUEMARK ID COLOR, BLUEMARK ID, BLUEMARK CLED, THERMOMARK PRIME, THERMOMARK CARD 2.0, THERMOMARK CARD, mounting type: snapped, for terminal block width: 3.5 mm, lettering field size: 2.7 x 4.7 mm, Number of individual labels: 108



# Plug - PP-H 1,5/S/1-M

3212688

<https://www.phoenixcontact.com/de/produkte/3212688>



## Shield connection clamp

Shield connection clamp - PSH 5-10 - 3040601

<https://www.phoenixcontact.com/de/produkte/3040601>



Shield connection clamp, color: black

---

## Marker for terminal blocks

Marker for terminal blocks - UCT-TMF 3,5 CUS - 0829644

<https://www.phoenixcontact.com/de/produkte/0829644>



Marker for terminal blocks, can be ordered: by sheet, white, labeled according to customer specifications, mounting type: snap into flat marker groove, for terminal block width: 3.5 mm, lettering field size: 2.7 x 4.7 mm, Number of individual labels: 108

# Plug - PP-H 1,5/S/1-M

3212688

<https://www.phoenixcontact.com/de/produkte/3212688>



## Cable housing

Cable housing - PH 1,5/S/3 - 3212756

<https://www.phoenixcontact.com/de/produkte/3212756>



Cable housing, pitch: 10.5 mm, length: 19.9 mm, width: 10.5 mm, height: 36.8 mm, number of positions: 3, color: gray

---

## Test plugs

Test plugs - MPS-MT - 0201744

<https://www.phoenixcontact.com/de/produkte/0201744>



Test plugs, with solder connection up to 1 mm<sup>2</sup> conductor cross section, color: gray

# Plug - PP-H 1,5/S/1-M

3212688

<https://www.phoenixcontact.com/de/produkte/3212688>



## Cable housing

Cable housing - PH 1,5/S/4 - 3212769

<https://www.phoenixcontact.com/de/produkte/3212769>



Cable housing, pitch: 14 mm, length: 19.9 mm, width: 14 mm, height: 36.8 mm, number of positions: 4, color: gray

---

## Insulating sleeve

Insulating sleeve - MPS-IH WH - 0201663

<https://www.phoenixcontact.com/de/produkte/0201663>

Insulating sleeve, color: white



# Plug - PP-H 1,5/S/1-M

3212688

<https://www.phoenixcontact.com/de/produkte/3212688>



## Cable housing

Cable housing - PH 1,5/S/5 - 3212772

<https://www.phoenixcontact.com/de/produkte/3212772>



Cable housing, pitch: 17.5 mm, length: 19.9 mm, width: 17.5 mm, height: 36.8 mm, number of positions: 5, color: gray

---

## Insulating sleeve

Insulating sleeve - MPS-IH RD - 0201676

<https://www.phoenixcontact.com/de/produkte/0201676>

Insulating sleeve, color: red



# Plug - PP-H 1,5/S/1-M

3212688

<https://www.phoenixcontact.com/de/produkte/3212688>



## Cable housing

Cable housing - PH 1,5/S/6 - 3212785

<https://www.phoenixcontact.com/de/produkte/3212785>



Cable housing, pitch: 21 mm, length: 19.9 mm, width: 21 mm, height: 36.8 mm, number of positions: 6, color: gray

---

## Insulating sleeve

Insulating sleeve - MPS-IH BU - 0201689

<https://www.phoenixcontact.com/de/produkte/0201689>

Insulating sleeve, color: blue

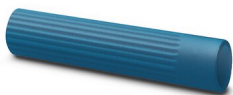

# Plug - PP-H 1,5/S/1-M

3212688

<https://www.phoenixcontact.com/de/produkte/3212688>



## Cable housing

Cable housing - PH 1,5/S/7 - 3212798

<https://www.phoenixcontact.com/de/produkte/3212798>



Cable housing, pitch: 24.5 mm, length: 19.9 mm, width: 24.5 mm, height: 36.8 mm, number of positions: 7, color: gray

---

## Insulating sleeve

Insulating sleeve - MPS-IH YE - 0201692

<https://www.phoenixcontact.com/de/produkte/0201692>

Insulating sleeve, color: yellow



# Plug - PP-H 1,5/S/1-M

3212688

<https://www.phoenixcontact.com/de/produkte/3212688>



## Cable housing

Cable housing - PH 1,5/S/8 - 3212808

<https://www.phoenixcontact.com/de/produkte/3212808>



Cable housing, pitch: 28 mm, length: 19.9 mm, width: 28 mm, height: 36.8 mm, number of positions: 8, color: gray

---

## Insulating sleeve

Insulating sleeve - MPS-IH GN - 0201702

<https://www.phoenixcontact.com/de/produkte/0201702>

Insulating sleeve, color: green



# Plug - PP-H 1,5/S/1-M

3212688

<https://www.phoenixcontact.com/de/produkte/3212688>



## Cable housing

Cable housing - PH 1,5/S/9 - 3212811

<https://www.phoenixcontact.com/de/produkte/3212811>



Cable housing, pitch: 31.5 mm, length: 19.9 mm, width: 31.5 mm, height: 36.8 mm, number of positions: 9, color: gray

---

## Insulating sleeve

Insulating sleeve - MPS-IH GY - 0201728

<https://www.phoenixcontact.com/de/produkte/0201728>

Insulating sleeve, color: gray





# Plug - PP-H 1,5/S/1-M

3212688

<https://www.phoenixcontact.com/de/produkte/3212688>



## Cable housing

Cable housing - PH 1,5/S/10 - 3212824

<https://www.phoenixcontact.com/de/produkte/3212824>



Cable housing, pitch: 35 mm, length: 19.9 mm, width: 35 mm, height: 36.8 mm, number of positions: 10, color: gray

---

## Insulating sleeve

Insulating sleeve - MPS-IH BK - 0201731

<https://www.phoenixcontact.com/de/produkte/0201731>

Insulating sleeve, color: black



# Plug - PP-H 1,5/S/1-M

3212688

<https://www.phoenixcontact.com/de/produkte/3212688>



## Cable housing

Cable housing - PH 1,5/S/11 - 3212837

<https://www.phoenixcontact.com/de/produkte/3212837>



Cable housing, pitch: 38.5 mm, length: 19.9 mm, width: 38.5 mm, height: 36.8 mm, number of positions: 11, color: gray

---

## Cable housing

Cable housing - PH 1,5/S/12 - 3212840

<https://www.phoenixcontact.com/de/produkte/3212840>

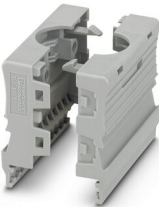

Cable housing, pitch: 42 mm, length: 19.9 mm, width: 42 mm, height: 36.8 mm, number of positions: 12, color: gray

# Plug - PP-H 1,5/S/1-M

3212688

<https://www.phoenixcontact.com/de/produkte/3212688>



## Cable housing

Cable housing - PH 1,5/S/13 - 3212853

<https://www.phoenixcontact.com/de/produkte/3212853>

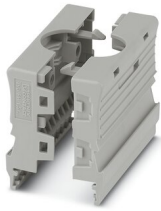

Cable housing, pitch: 45.5 mm, length: 19.9 mm, width: 45.5 mm, height: 36.8 mm, number of positions: 13, color: gray

---

## Cable housing

Cable housing - PH 1,5/S/14 - 3212866

<https://www.phoenixcontact.com/de/produkte/3212866>



Cable housing, pitch: 49 mm, length: 19.9 mm, width: 49 mm, height: 36.8 mm, number of positions: 14, color: gray

# Plug - PP-H 1,5/S/1-M

3212688

<https://www.phoenixcontact.com/de/produkte/3212688>



## Cable housing

Cable housing - PH 1,5/S/15 - 3212879

<https://www.phoenixcontact.com/de/produkte/3212879>

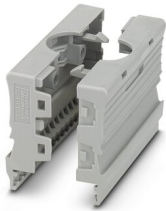

Cable housing, pitch: 52.5 mm, length: 19.9 mm, width: 52.5 mm, height: 36.8 mm, number of positions: 15, color: gray

---

## Screwdriver

Screwdriver - SZF 0-0,4X2,5 - 1204504

<https://www.phoenixcontact.com/de/produkte/1204504>



Actuation tool, for ST terminal blocks, also suitable for use as a bladed screwdriver, size: 0.4 x 2.5 x 75 mm, 2-component grip, with non-slip grip

# Plug - PP-H 1,5/S/1-M

3212688

<https://www.phoenixcontact.com/de/produkte/3212688>



## Actuation tool

Actuation tool - ST-BW 0 - 1200135

<https://www.phoenixcontact.com/de/produkte/1200135>

Actuation tool, for all 1.5 mm<sup>2</sup> spring cages from PT 1,5/S and FT 1,5/S



---

## Ferrule

Ferrule - AI-S 1 - 8 TQ - 1200293

<https://www.phoenixcontact.com/de/produkte/1200293>

Ferrule, S-Slimline, sleeve length: 8 mm, length: 14.5 mm, color: turquoise



---

Phoenix Contact 2022 © - all rights reserved  
<https://www.phoenixcontact.com>

PHOENIX CONTACT Deutschland GmbH  
Flachsmarktstraße 8  
D-32825 Blomberg  
+49 52 35/3-1 20 00  
[info@phoenixcontact.de](mailto:info@phoenixcontact.de)