

Betaduct PVC Narrow Slot Cable Trunking

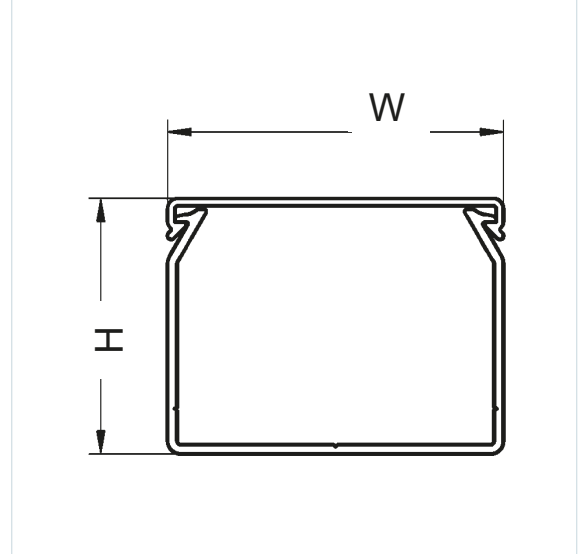
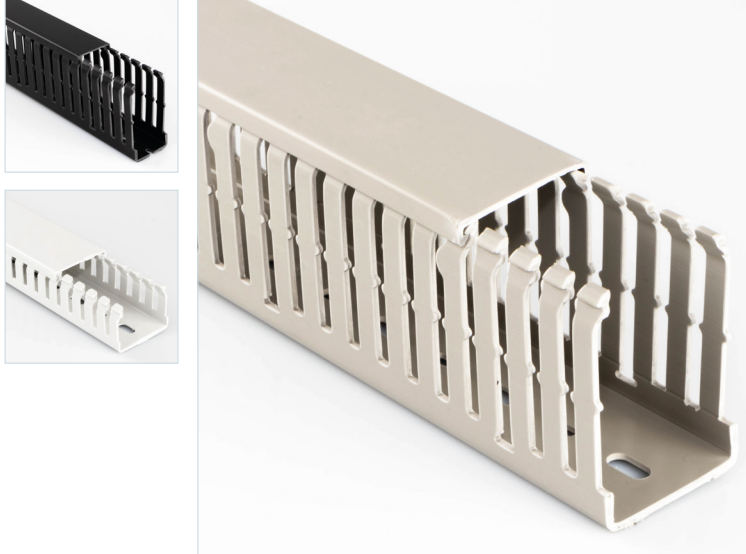

Specification

Material	Rigid PVC 9051 LF
Colour	Grey RAL7030, Black RAL9005
Operating Temp	-5°C to +60°C
Volume Resistivity	1 E15 Ohm. cm
Dielectric Strength	15 kV/mm
Flame Resistance	VO UL94
Tensile Strength	>40 MPa
Ultimate Elongation	>160%
Weather Resistance	Good
Stabilization	Calcium / Zinc
Glow Wire Flammability	+960°C EN 60695-2-11
UL Recognised	UL 1565 E509564
CSA Recognised	CSA-C22.2 No. 18.5 E509564
Design	EN50085-1 & EN50085-2-3

Key Features

- Lightweight and self-extinguishing
- Excellent rigidity and performance characteristics
- Easy installation
- Base holes to EN 50085-2-3
- Break points on fingers and base
- Secure clip on lid
- Supplied in 2m lengths

Spare lids available













Part Number			Nominal External (mm)		Lengths Per Pack	Base Punching	Quantity Per Pack (m)
Grey	Black	White	Height	Width			
10470022Y	10490022Y	23630400Y	37.5	25	12	1 Row	24
10470023Y	10490023Y	23630500Y	50	25	12	1 Row	24
10470024Y	10490024Y	23630600Y	75	25	8	1 Row	16
10470032Y	10490032Y		37.5	37.5	12	1 Row	24
10470033Y	10490033Y		50	37.5	8	1 Row	16
10470034Y	10490034Y	23631100Y	75	37.5	8	1 Row	16

Betaduct PVC Narrow Slot Cable Trunking

Part Number			Nominal External (mm)		Lengths Per Pack	Base Punching	Quantity Per Pack (m)
Grey	Black	White	Height	Width			
10470052Y	10490052Y		37.5	50	8	1 Row	16
10470053Y	10490053Y	23631500Y	50	50	8	1 Row	16
10470054Y	10490054Y	23631600Y	75	50	8	1 Row	16
10470055Y	10490055Y	23631700Y	100	50	4	1 Row	8
10470073Y	10490073Y		50	75	8	3 Row	16
10470074Y	10490074Y		75	75	8	3 Row	16
10470075Y	10490075Y	23632100Y	100	75	4	3 Row	8
10470103Y	10490103Y		50	100	4	3 Row	8
10470104Y	10490104Y		75	100	4	3 Row	8
10470105Y	10490105Y	23632600Y	100	100	4	3 Row	8

You might also need...

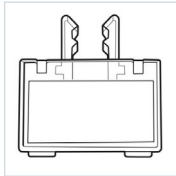
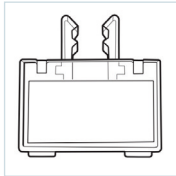
<p>EDC1</p>  <p>Betaduct Trunking Cutting Tool</p> <ul style="list-style-type: none"> • Blade W: 21.5mm • Cutting D: 50mm 	<p>BETADUCT-CUTTER</p>  <p>Betaduct Trunking Cutting Tool</p> <ul style="list-style-type: none"> • Cuts up to 125mm 	<p>EDC 2</p>  <p>Betaduct Trunking Cutting Tool</p> <ul style="list-style-type: none"> • Cuts up to 110mm 	<p>1857</p>  <p>Betaduct Trunking Cutting Tool</p> <ul style="list-style-type: none"> • Ideal for cutting slots in trunking 	<p>RT4 or RT6</p>  <p>Betaduct Trunking Rivet Tools</p> <ul style="list-style-type: none"> • 4.5mm (RT4) • 6.5mm (RT6) 	<p>DUCTAFIX R4 or R6</p>  <p>Betaduct Trunking Rivets</p> <ul style="list-style-type: none"> • 4mm (R4) • 6mm (R6)
<p>10440000</p>  <p>Betaduct Insulating Washers</p> <ul style="list-style-type: none"> • Black • Pack of 50 	<p>RC1</p>  <p>Retaining Clip For Narrow Trunking</p> <ul style="list-style-type: none"> • 53mm x 66mm • Pack of 50 	<p>BC1</p>  <p>HF Bridging Clip For Narrow Trunking</p> <ul style="list-style-type: none"> • 22.5mm x 105mm • Pack of 50 	<p>BC2</p>  <p>HF Bridging Clip For Narrow Trunking</p> <ul style="list-style-type: none"> • 24mm x 108mm • Pack of 50 	<p>LH1</p>  <p>Label Holder For Narrow Trunking</p> <ul style="list-style-type: none"> • 25.5mm x 13mm • Pack of 50 	<p>LH2</p>  <p>Label Holder For Narrow Trunking</p> <ul style="list-style-type: none"> • 38mm x 19mm • Pack of 50

Betaduct PVC Narrow Slot Cable Trunking

H = 25 mm

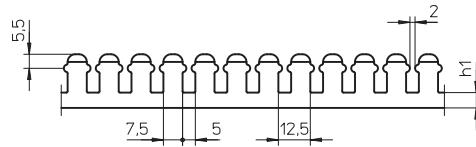
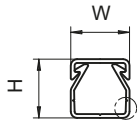

W = 25, 37.5 and 50 mm

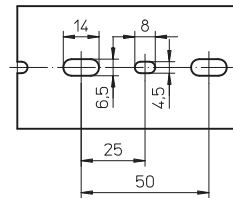

H = 37.5 mm

H = 50 mm

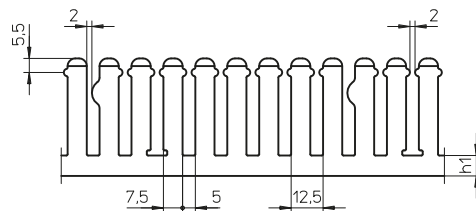
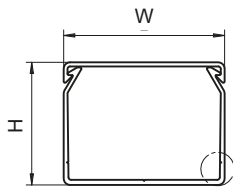

H = 75 mm

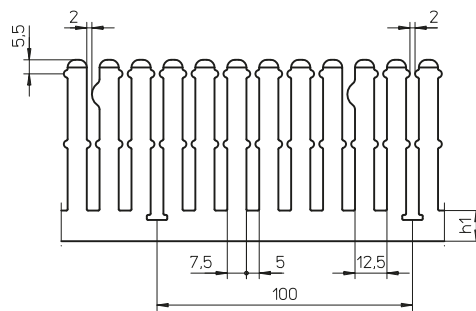
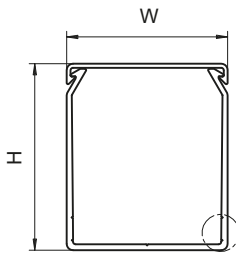

W = 75, 100, 125 and 150 mm

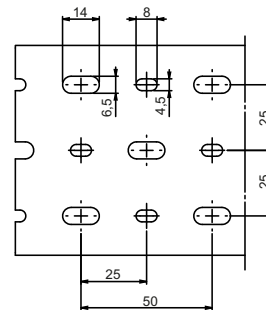

H = 100 mm

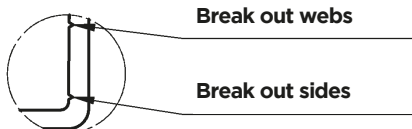
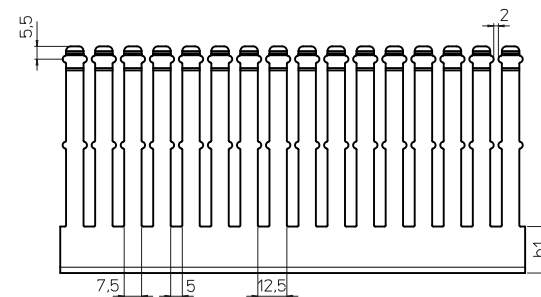
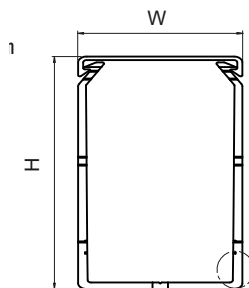

Base punching to EN 50085-2-3

H (mm)	25	37.5	50	75	100
h1 (mm)	5	7	9	11	20

Betaduct Trunking Capacity Chart

Trunking Nominal External Width x Height (mm)	Internal Cross Sectional Area (mm ²)	At 50% Packing Density (mm ²)	Cable Cross Sectional Area (mm ²) Tri-Rated Cable BS6231															
			0.50	0.75	1.00	1.50	2.50	4.00	6.00	10.00	16.00	25.00	35.00	50.00	70.00	95.00		
			2.63	2.83	3.00	3.30	3.70	4.40	4.90	6.50	9.05	10.55	11.90	14.75	16.55	18.75		
25 x 37.5	608	304	55	48	43	35	28	19	16	9	4	3	2	1	1	1	1	1
25 x 50	836	418	76	66	59	48	38	27	22	12	6	4	3	2	1	1	1	1
25 x 75	1311	655.5	120	104	92	76	60	43	34	19	10	7	5	3	3	3	2	2
37.5 x 37.5	1024	512	94	81	72	59	47	33	27	15	7	5	4	2	2	2	1	1
37.5 x 50	1408	704	129	111	99	82	65	46	37	21	10	8	6	4	3	2	2	2
37.5 x 75	2208	1104	203	175	156	129	102	72	58	33	17	12	9	6	5	3	3	3
50 x 37.5	1408	704	129	111	99	82	65	46	37	21	10	8	6	4	3	2	2	2
50 x 50	1936	968	178	153	136	113	90	63	51	29	15	11	8	5	4	3	3	3
50 x 75	3036	1518	279	241	214	177	141	99	80	45	23	17	13	8	7	5	5	5
50 x 100	4136	2068	380	328	292	241	192	136	109	62	32	23	18	12	9	7	7	7
75 x 37.5	2208	1104	203	175	156	129	102	72	58	33	17	12	9	6	5	3	3	3
75 x 50	3036	1518	279	241	214	177	141	99	80	45	23	17	13	8	7	5	5	5
75 x 75	4761	2380.5	438	378	336	278	221	156	126	71	37	27	21	13	11	8	8	8
75 x 100	6486	3243	596	515	458	379	301	213	171	97	50	37	29	18	15	11	11	11
100 x 50	4136	2068	380	328	292	241	192	136	109	62	32	23	18	12	9	7	7	7
100 x 75	6486	3243	596	515	458	379	301	213	171	97	50	37	29	18	15	11	11	11
100 x 100	8836	4418	813	702	625	516	410	290	234	133	68	50	39	25	20	16	16	16
150 x 100	13536	6768	1245	1075	957	791	629	445	358	203	105	77	60	39	31	24	24	24
125 x 75	8142	4071	749	647	575	475	378	267	215	122	63	46	36	23	18	14	14	14

*UL application fill rates may vary, more information is available on request.