

Single relay - REL-MR- 60DC/21

2961118

<https://www.phoenixcontact.com/de/produkte/2961118>



Please be informed that the data shown in this PDF document is generated from our Online Catalog. Please find the complete data in the user documentation. Our General Terms of Use for Downloads are valid.

Plug-in miniature power relay, with power contact, 1 changeover contact, input voltage 60 V DC

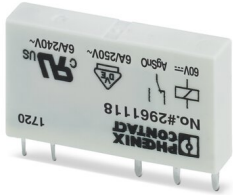

Your advantages

- Safe isolation according to DIN EN 50178 between coil and contact
- High degree of protection up to RT III depending on type (wash-proof)
- Power contacts up to 6 A

Single relay - REL-MR- 60DC/21



2961118

<https://www.phoenixcontact.com/de/produkte/2961118>

Commercial Data

Item number	2961118
Packing unit	10 pc
Minimum order quantity	10 pc
Note	Made to Order (non-returnable)
Sales Key	G1 - Relais
Product Key	CK6195
Catalog Page	Page 394 (C-5-2019)
GTIN	4017918130886
Weight per Piece (including packing)	6,728 g
Weight per Piece (excluding packing)	6,6 g
Customs tariff number	85364900
Country of origin	CZ

Single relay - REL-MR- 60DC/21



2961118

<https://www.phoenixcontact.com/de/produkte/2961118>

Technical Data

Product properties

Product type	Single relay
Set comprises	2966139 PLC-RSC- 60DC/21
	2966197 PLC-RSC-120UC/21
	2980021 PLC-RSC-125DC/21
	2966207 PLC-RSC-230UC/21
	2966511 PLC-RSP- 60DC/21
	2966524 PLC-RSP-120UC/21
	2966537 PLC-RSP-230UC/21
	2900303 PLC-RPT- 60DC/21
	2900304 PLC-RPT-120UC/21
	2900305 PLC-RPT-230UC/21
	2987053 PLC-RSP-110UC/21/RW
2900320 PLC-RPT-110UC/21/RW	
Operating mode	100% operating factor
Mechanical service life	2x 10 ⁷ cycles

Insulation characteristics

Overvoltage category	III
Pollution degree	3

Electrical properties

Maximum power dissipation for nominal condition	0.18 W
Test voltage	4 kV AC (50 Hz, 1 min., winding/contact)

Input data

Coil side

Nominal input voltage U _N	60 V DC
Input voltage range	36 V DC ... 165 V DC
Typical input current at U _N	3 mA
Typical response time	5 ms
Typical release time	2.5 ms
Coil resistance	20500 Ω ±15 % (at 20 °C)

Output data

Switching

Contact type	1 changeover contact
Type of switch contact	Single contact
Drive and function	monostable
Contact material	AgSnO
Maximum switching voltage	250 V AC/DC

Single relay - REL-MR- 60DC/21

2961118

<https://www.phoenixcontact.com/de/produkte/2961118>

Minimum switching voltage	5 V (at 100 mA)
Limiting continuous current	6 A
Maximum inrush current	10 A (4 s)
Min. switching current	10 mA (at 12 V)
Interrupting rating (ohmic load) max.	140 W (at 24 V DC) 20 W (at 48 V DC) 18 W (at 60 V DC) 23 W (at 110 V DC) 40 W (at 220 V DC) 1500 VA (for 250 V AC)
Switching capacity	2 A (at 24 V, DC13) 0.2 A (at 110 V, DC13) 0.1 A (at 220 V, DC13) 3 A (at 24 V, AC15) 3 A (at 120 V, AC15) 3 A (at 230 V, AC15)
Motor load according to UL 508	1/4 HP, 240 - 277 V AC (N/O contact) 1/6 HP, 240 - 277 V AC (N/C contact)

Connection data

Connection method	Solder connection
-------------------	-------------------

Dimensions

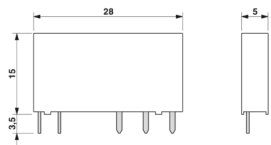
Dimensional drawing	
Width	5 mm
Height	28 mm
Depth	15 mm

Environmental and real-life conditions

Ambient conditions

Degree of protection	RT III
Ambient temperature (operation)	-40 °C ... 85 °C
Ambient temperature (storage/transport)	-40 °C ... 85 °C

Approval data

Corrosive gas test

Identification	ISA-S71.04. G3 Harsh Group EN 60068-2-60
----------------	---

Single relay - REL-MR- 60DC/21



2961118

<https://www.phoenixcontact.com/de/produkte/2961118>

Standards and regulations

Standards/regulations	IEC 60664
	EN 50178
	EN 61810-1

Mounting

Assembly instructions	in rows with zero spacing
Mounting position	any

Single relay - REL-MR- 60DC/21

2961118

<https://www.phoenixcontact.com/de/produkte/2961118>

Drawings

Diagram

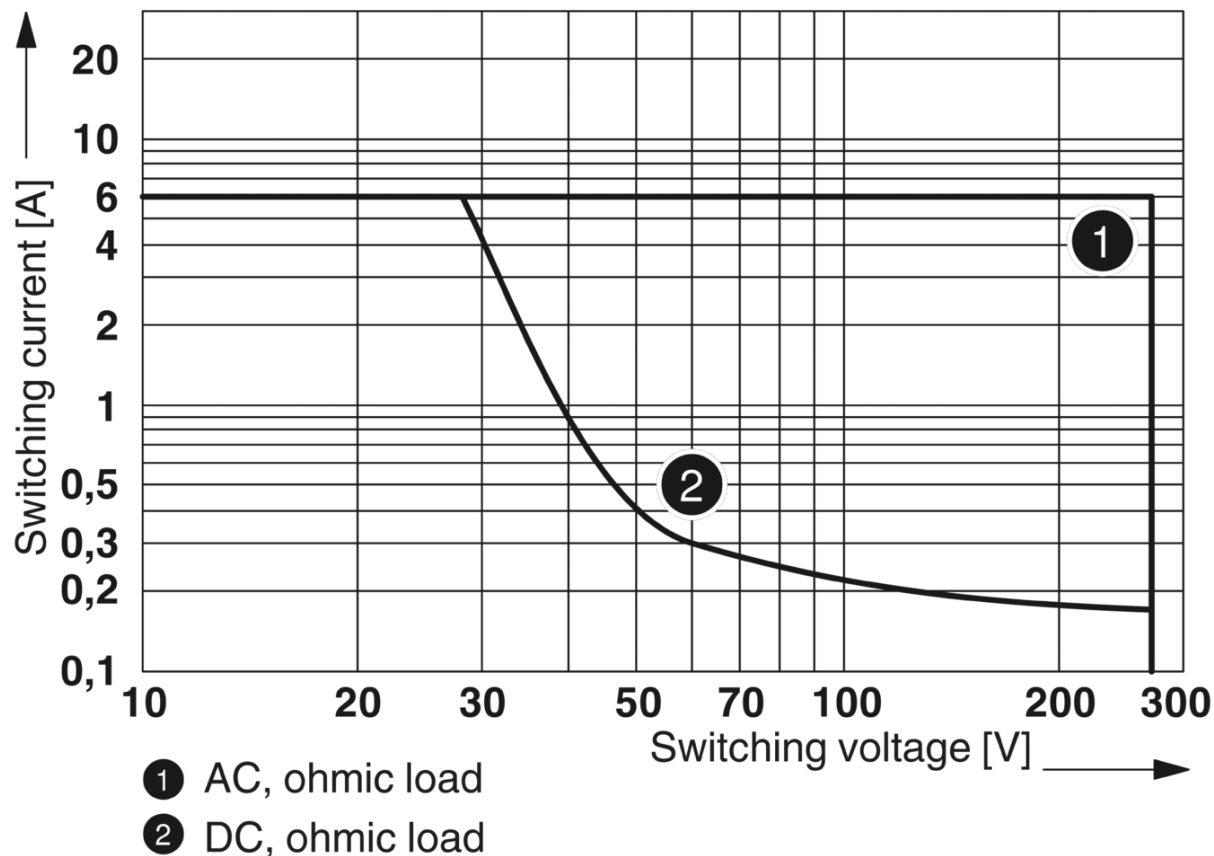

Interrupting rating

Circuit diagram

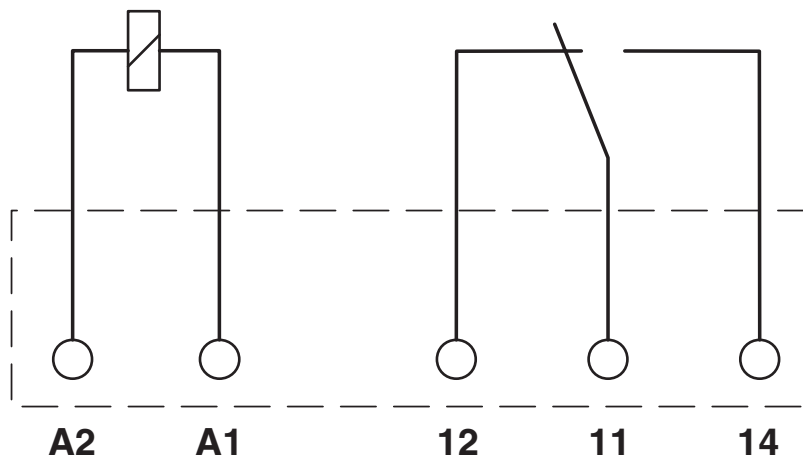

Single relay - REL-MR- 60DC/21

2961118

<https://www.phoenixcontact.com/de/produkte/2961118>

Drilling plan/solder pad geometry

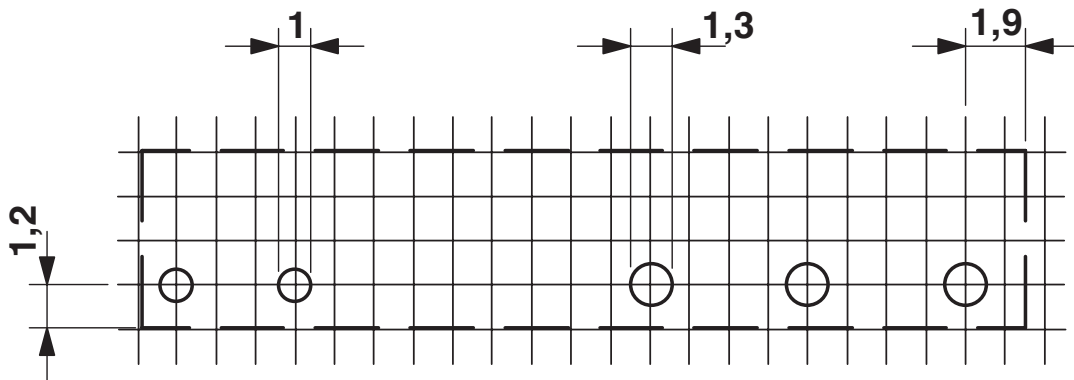

a = pitch division 1.25 mm and 1.27 mm

Diagram

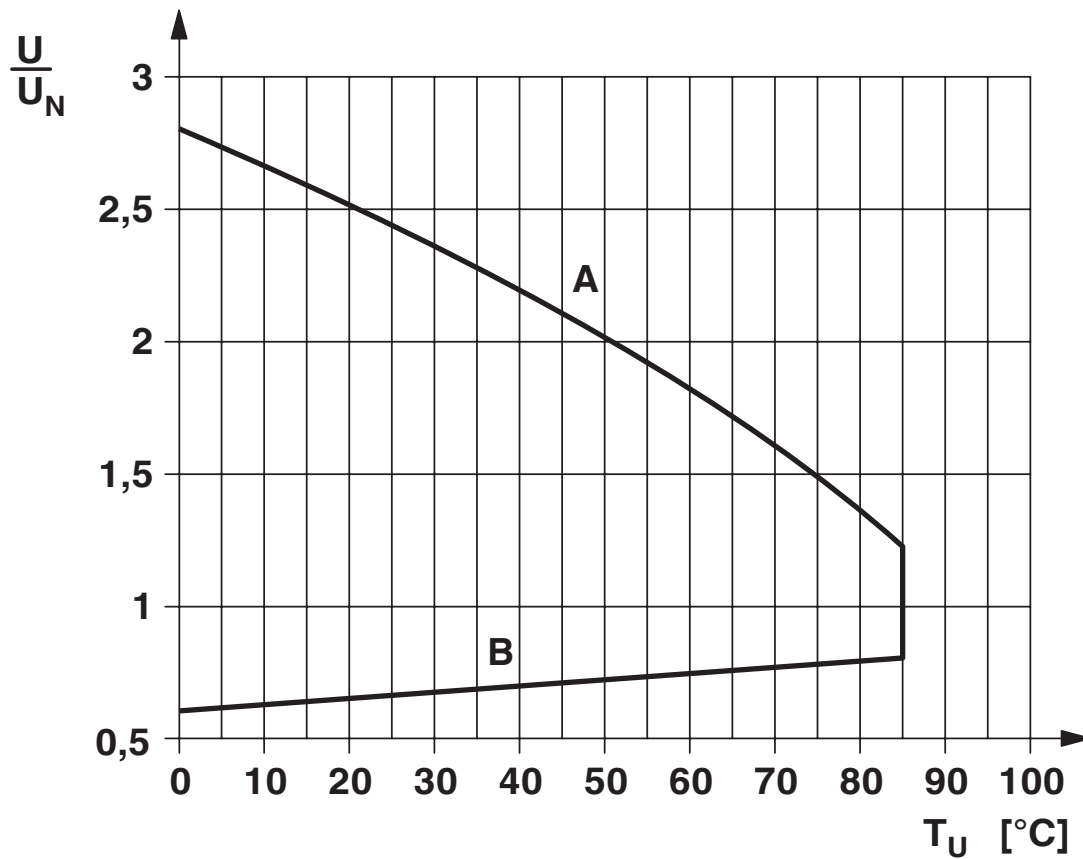

Single relay - REL-MR- 60DC/21

2961118

<https://www.phoenixcontact.com/de/produkte/2961118>

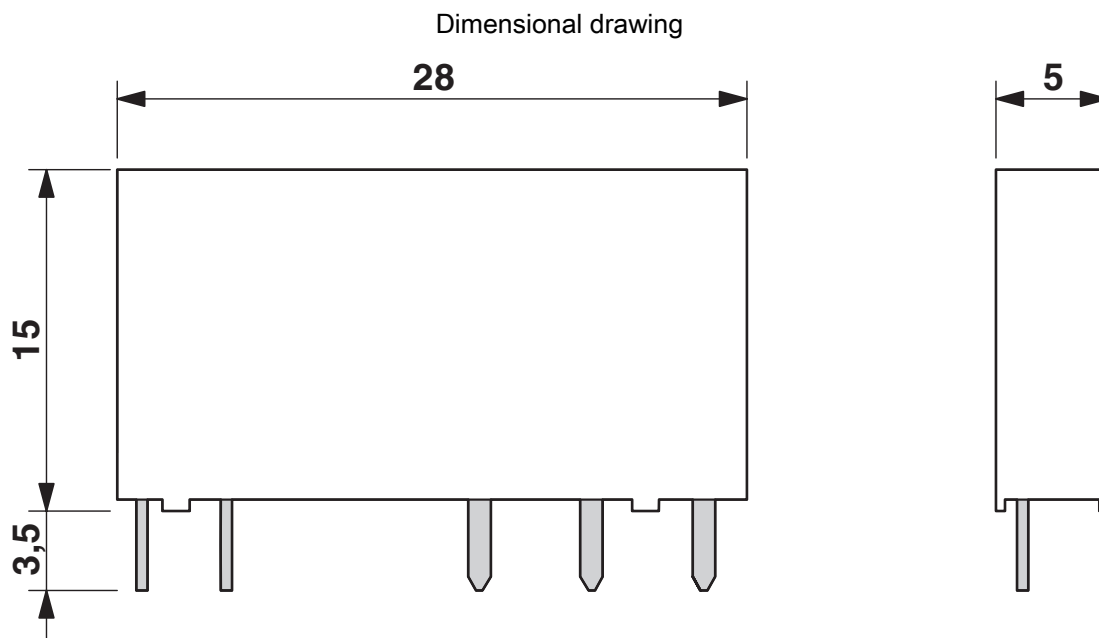

Single relay - REL-MR- 60DC/21



2961118

<https://www.phoenixcontact.com/de/produkte/2961118>

Approvals



cUL Recognized
Approval ID: FILE E 172140



UL Recognized
Approval ID: FILE E 172140



EAC
Approval ID: TR_TS_D_00573_c



UL Recognized
Approval ID: FILE E 172140



EAC
Approval ID: RU*C-DE.*08.B.00010



VDE Zeichengenehmigung
Approval ID: 40010212

	Nominal Voltage U_N	Nominal Current I_N	Cross Section AWG	Cross Section mm^2
Reports with production monitoring			-	-



VDE Zeichengenehmigung
Approval ID: 40032864

	Nominal Voltage U_N	Nominal Current I_N	Cross Section AWG	Cross Section mm^2
Mark approval certificate			-	-



PRS
Approval ID: TE/2109/880590/16



cUL Recognized
Approval ID: FILE E 172140



VDE Zeichengenehmigung
Approval ID: 40054426

Single relay - REL-MR- 60DC/21



2961118

<https://www.phoenixcontact.com/de/produkte/2961118>

Classifications

ECLASS

ECLASS-9.0	27371601
ECLASS-10.0.1	27371601
ECLASS-11.0	27371601

ETIM

ETIM 8.0	EC001437
----------	----------

UNSPSC

UNSPSC 21.0	39122300
-------------	----------

Single relay - REL-MR- 60DC/21

2961118

<https://www.phoenixcontact.com/de/produkte/2961118>



Environmental Product Compliance

China RoHS	Environmentally friendly use period: unlimited = EFUP-e
	No hazardous substances above threshold values

Single relay - REL-MR- 60DC/21

2961118

<https://www.phoenixcontact.com/de/produkte/2961118>



Accessories

Relay base

Relay base - PLC-BPT- 60DC/21 - 2900279

<https://www.phoenixcontact.com/de/produkte/2900279>



6.2 mm PLC basic terminal block with Push-in connection, without relay or solid-state relay, for mounting on DIN rail NS 35/7,5, 1 changeover contact, input voltage 60 V DC

Relay base

Relay base - PLC-BSC- 60DC/21 - 2966100

<https://www.phoenixcontact.com/de/produkte/2966100>



6.2 mm PLC basic terminal block with screw connection, without relay or solid-state relay, for mounting on DIN rail NS 35/7,5, 1 changeover contact, input voltage 60 V DC

Single relay - REL-MR- 60DC/21

2961118

<https://www.phoenixcontact.com/de/produkte/2961118>



Relay base

Relay base - PLC-BPT-120UC/21 - 2900280

<https://www.phoenixcontact.com/de/produkte/2900280>



6.2 mm PLC basic terminal block with Push-in connection, without relay or solid-state relay, for mounting on DIN rail NS 35/7,5, 1 changeover contact, input voltage 120 V AC/DC

Relay base

Relay base - PLC-BSC-120UC/21 - 2966032

<https://www.phoenixcontact.com/de/produkte/2966032>



6.2 mm PLC basic terminal block with screw connection, without relay or solid-state relay, for mounting on DIN rail NS 35/7,5, 1 changeover contact, input voltage 120 V AC/DC

Single relay - REL-MR- 60DC/21

2961118

<https://www.phoenixcontact.com/de/produkte/2961118>



Relay base

Relay base - PLC-BSC-125DC/21 - 2980018

<https://www.phoenixcontact.com/de/produkte/2980018>



6.2 mm PLC basic terminal block with screw connection, without relay or solid-state relay, for mounting on DIN rail NS 35/7,5, 1 changeover contact, input voltage 125 V DC

Relay base

Relay base - PLC-BPT-230UC/21 - 2900281

<https://www.phoenixcontact.com/de/produkte/2900281>



6.2 mm PLC basic terminal block with Push-in connection, without relay or solid-state relay, for mounting on DIN rail NS 35/7,5, 1 changeover contact, input voltage 230 V AC/DC

Single relay - REL-MR- 60DC/21

2961118

<https://www.phoenixcontact.com/de/produkte/2961118>



Relay base

Relay base - PLC-BSC-230UC/21 - 2966045

<https://www.phoenixcontact.com/de/produkte/2966045>



6.2 mm PLC basic terminal block with screw connection, without relay or solid-state relay, for mounting on DIN rail NS 35/7,5, 1 changeover contact, input voltage 230 V AC/DC

Relay base

Relay base - PLC-BPT-120UC/ 1/SEN - 2900451

<https://www.phoenixcontact.com/de/produkte/2900451>



6.2 mm PLC basic terminal block for input functions with push-in connection, without relay or solid-state relay, for mounting on DIN rail NS 35/7,5, with sensor supply voltage distribution (BB), 1 N/O contact, input voltage 120 V AC/DC

Single relay - REL-MR- 60DC/21

2961118

<https://www.phoenixcontact.com/de/produkte/2961118>



Relay base

Relay base - PLC-BSC-120UC/ 1/SEN - 2966074

<https://www.phoenixcontact.com/de/produkte/2966074>



6.2 mm PLC basic terminal block for input functions with screw connection, without relay or solid-state relay, for mounting on DIN rail NS 35/7,5, with sensor supply voltage distribution (BB), 1 N/O contact, input voltage 120 V AC/DC

Relay base

Relay base - PLC-BPT-230UC/ 1/SEN - 2900452

<https://www.phoenixcontact.com/de/produkte/2900452>



6.2 mm PLC basic terminal block for input functions with push-in connection, without relay or solid-state relay, for mounting on DIN rail NS 35/7,5, with sensor supply voltage distribution (BB), 1 N/O contact, input voltage 230 V AC/DC

Single relay - REL-MR- 60DC/21

2961118

<https://www.phoenixcontact.com/de/produkte/2961118>



Relay base

Relay base - PLC-BSC-230UC/ 1/SEN - 2966087

<https://www.phoenixcontact.com/de/produkte/2966087>



6.2 mm PLC basic terminal block for input functions with screw connection, without relay or solid-state relay, for mounting on NS 35/7,5 DIN rail, with sensor supply voltage distribution (BB), 1 N/O contact, input voltage: 230 V AC/DC

Relay base

Relay base - PLC-BPT-120UC/21/SO46 - 2900453

<https://www.phoenixcontact.com/de/produkte/2900453>



6.2 mm PLC basic terminal block against interference currents/voltages on the control side with Push-in connection, without relay or solid-state relay, for mounting on DIN rail NS 35/7,5, with integrated RCZ filter, 1 changeover contact, input voltage 120 V AC

Single relay - REL-MR- 60DC/21

2961118

<https://www.phoenixcontact.com/de/produkte/2961118>

Relay base

Relay base - PLC-BSC-120UC/21/SO46 - 2980319

<https://www.phoenixcontact.com/de/produkte/2980319>



6.2 mm PLC basic terminal block with protection against interference currents/voltages on the control side, with screw connection, without relay or solid-state relay, for mounting on DIN rail NS 35/7,5, with integrated RCZ filter, 1 changeover contact, input voltage 120 V AC

Relay base

Relay base - PLC-BPT-230UC/21/SO46 - 2900455

<https://www.phoenixcontact.com/de/produkte/2900455>



6.2 mm PLC basic terminal block against interference currents/voltages on the control side with Push-in connection, without relay or solid-state relay, for mounting on DIN rail NS 35/7,5, with integrated RCZ filter, 1 changeover contact, input voltage 230 V AC

Single relay - REL-MR- 60DC/21

2961118

<https://www.phoenixcontact.com/de/produkte/2961118>

Relay base

Relay base - PLC-BSC-230UC/21/SO46 - 2980335

<https://www.phoenixcontact.com/de/produkte/2980335>



6.2 mm PLC basic terminal block with protection against interference currents/voltages on the control side, with screw connection, without relay or solid-state relay, for mounting on DIN rail NS 35/7,5, with integrated RCZ filter, 1 changeover contact, input voltage 230 V AC

Relay base

Relay base - PLC-BPT-120UC/ 1/SEN/SO46 - 2900456

<https://www.phoenixcontact.com/de/produkte/2900456>



6.2 mm PLC basic terminal block with interference current and interference voltage protection on the control side, with push-in connection, without relay or solid-state relay, with sensor supply voltage distribution (BB), 1 N/O contact, input voltage 120 V AC

Single relay - REL-MR- 60DC/21

2961118

<https://www.phoenixcontact.com/de/produkte/2961118>



Relay base

Relay base - PLC-BSC-120UC/ 1/SEN/SO46 - 2980322

<https://www.phoenixcontact.com/de/produkte/2980322>



6.2 mm PLC basic terminal block with interference current and interference voltage protection on the control side, with screw connection, without relay or solid-state relay, with sensor supply voltage distribution (BB), 1 N/O contact, input voltage 120 V AC

Relay base

Relay base - PLC-BPT-230UC/ 1/SEN/SO46 - 2900457

<https://www.phoenixcontact.com/de/produkte/2900457>



6.2 mm PLC basic terminal block with interference current and interference voltage protection on the control side, with push-in connection, without relay or solid-state relay, with sensor supply voltage distribution (BB), 1 N/O contact, input voltage 230 V AC

Single relay - REL-MR- 60DC/21

2961118

<https://www.phoenixcontact.com/de/produkte/2961118>



Relay base

Relay base - PLC-BSC-230UC/ 1/SEN/SO46 - 2980348

<https://www.phoenixcontact.com/de/produkte/2980348>



6.2 mm PLC basic terminal block with interference current and interference voltage protection on the control side, with screw connection, without relay or solid-state relay, with sensor supply voltage distribution (BB), 1 N/O contact, input voltage 230 V AC

Phoenix Contact 2022 © - all rights reserved

<https://www.phoenixcontact.com>

PHOENIX CONTACT Deutschland GmbH

Flachsmarktstraße 8

D-32825 Blomberg

+49 52 35/3-1 20 00

info@phoenixcontact.de