

Contact insert - HC-B24-I-PT-F

1407735

<https://www.phoenixcontact.com/pc/products/1407735>



Please be informed that the data shown in this PDF document is generated from our Online Catalog. Please find the complete data in the user documentation. Our General Terms of Use for Downloads are valid.

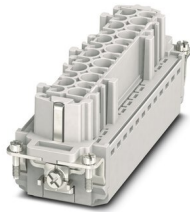

Contact insert, number of positions: 24+PE, size: B24, number of connections per position: 1, Socket, Push-in connection, 500 V, 16 A, 0.14 mm² ... 2.5 mm², application: Power

Your advantages

- Easy installation without tools, even when mounted, with push-in connection technology
- Shortest installation time compared to other connection technologies
- Quick and effortless wiring, in particular when space is tight
- Automatic cabling with robots possible
- Safe wiring and operation with color-coded actuators
- Shock and vibration-resistant in accordance with DIN EN 61373
- Cost-effective and fast coding with plastic profiles
- Test connection for 2 mm test plug

Contact insert - HC-B24-I-PT-F



1407735

<https://www.phoenixcontact.com/pc/products/1407735>

Commercial Data

Item number	1407735
Packing unit	1 pc
Minimum order quantity	1 pc
Product Key	BF7ABC
Catalog Page	Page 547 (C-2-2019)
GTIN	4046356777704
Weight per Piece (including packing)	116.1 g
Weight per Piece (excluding packing)	115 g
Customs tariff number	85366990
Country of origin	CN

Contact insert - HC-B24-I-PT-F

1407735

<https://www.phoenixcontact.com/pc/products/1407735>

Technical Data

Notes

General	only use flexible conductors with ferrules
General	Connectors may be operated only when there is no load/voltage.

Product properties

Type	B24 B48
Product type	Contact insert with a fixed no. of positions
Number of positions	24
Connection profile	24+PE
Application	Power
Number of connections per position	1
Contact type	rolled
Series	HC-B

Insulation characteristics

Overvoltage category	III
Degree of pollution	3

Connection data

Connection technology

Connection technology	Push-in connection
Number of connections per position	1

Conductor connection

Connection cross section AWG	26 ... 14
Stripping length	8 mm ... 10 mm

Dimensions

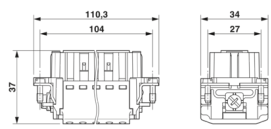
Dimensional drawing	
Width	34 mm
Height	37 mm
Length	111 mm
Drill hole distance, horizontal	104 mm
Drill hole distance, vertical	27 mm

Mechanical characteristics

Contact diameter	2.5 mm
------------------	--------

Contact insert - HC-B24-I-PT-F



1407735

<https://www.phoenixcontact.com/pc/products/1407735>

Electrical properties

Rated voltage (III/3)	500 V
Rated surge voltage	6 kV
Rated current	16 A (power contacts)
SCCR	5 kA (UL 2237)

Material specifications

Flammability rating according to UL 94	V0
Contact material	Copper alloy
Contact surface material	Ag/Sn (tarnish protection)
Contact carrier material	PC
Standards/regulations	PC: Fire protection in rail vehicles - requirement sets R22, R23, and R24 acc. to DIN EN 45545-2 (Risk level HL1 - HL3)

Connector

Insertion/withdrawal cycles	≥ 500
-----------------------------	-------

Mounting

Assembly instructions	To ensure correct use, installation in housing with IP54 protection or better is required
-----------------------	---

Ambient conditions

Ambient temperature (operation)	-40 °C ... 125 °C (including heating up of contacts)
---------------------------------	--

Standards and regulations

Testing

Standards/regulations	PC: Fire protection in rail vehicles - requirement sets R22, R23, and R24 acc. to DIN EN 45545-2 (Risk level HL1 - HL3)
-----------------------	---

Contact insert - HC-B24-I-PT-F

1407735

<https://www.phoenixcontact.com/pc/products/1407735>



Drawings

Schematic diagram

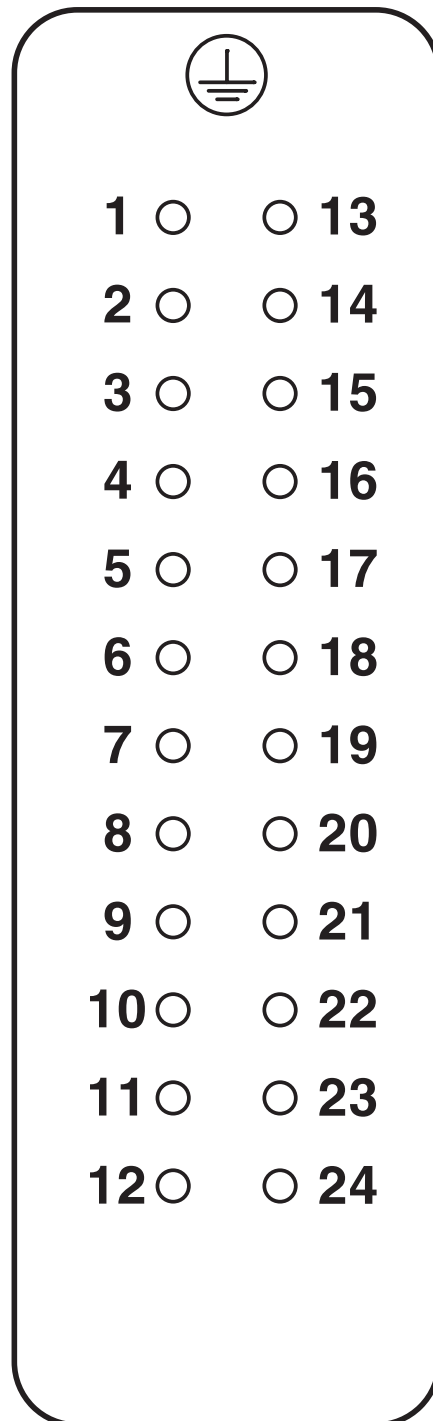

Connector pin assignment, connection side

Contact insert - HC-B24-I-PT-F

1407735

<https://www.phoenixcontact.com/pc/products/1407735>

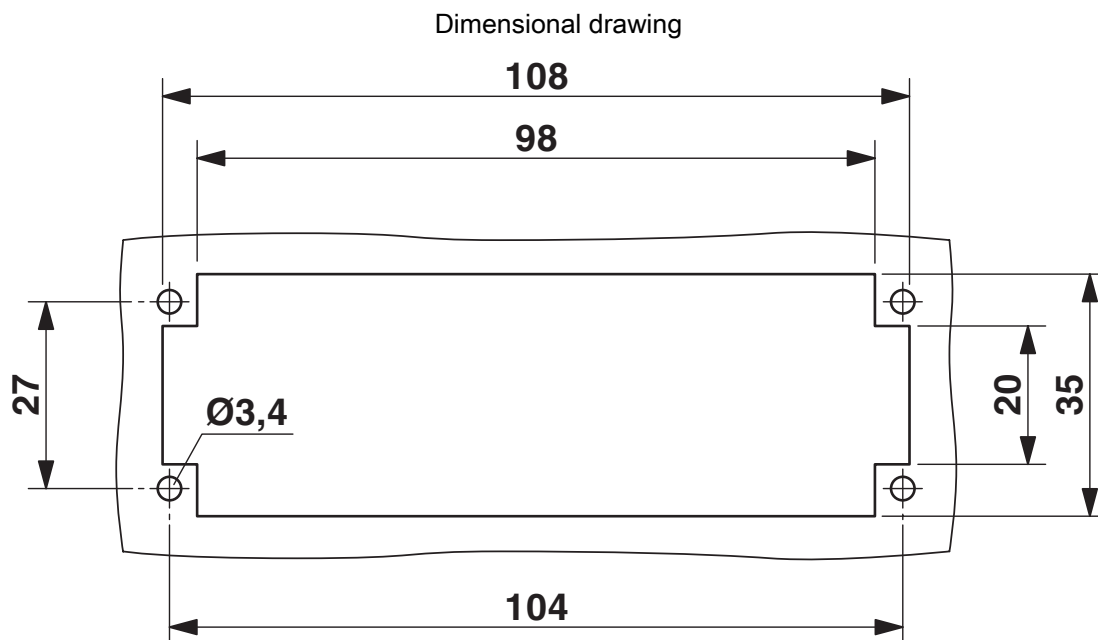

Mounting cutout when used without housing

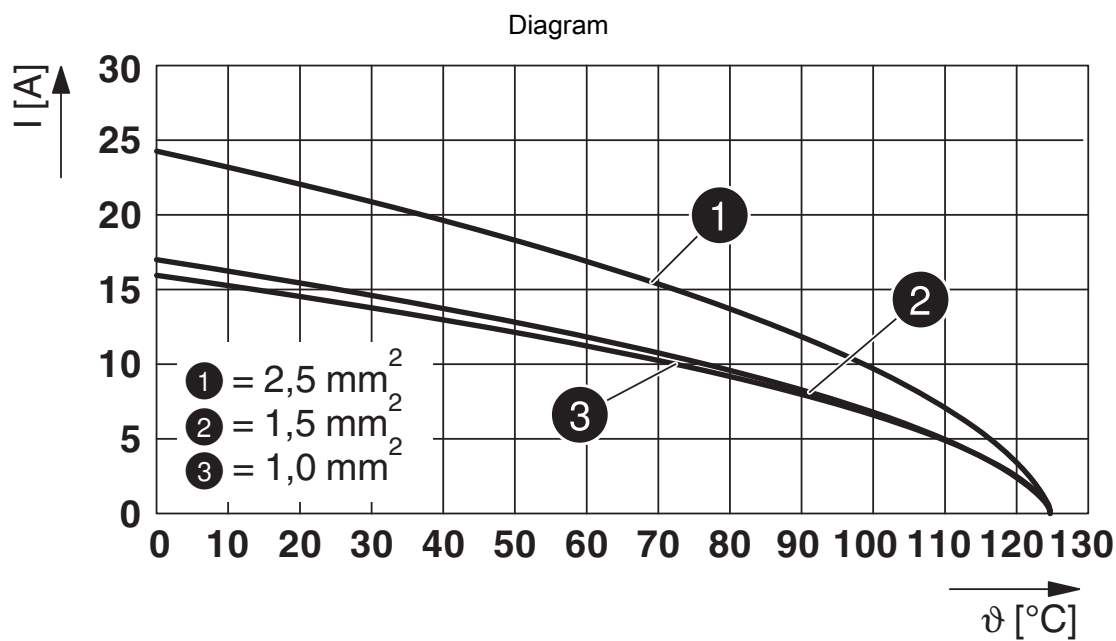

Derating diagram

Contact insert - HC-B24-I-PT-F

1407735

<https://www.phoenixcontact.com/pc/products/1407735>



Dimensional drawing

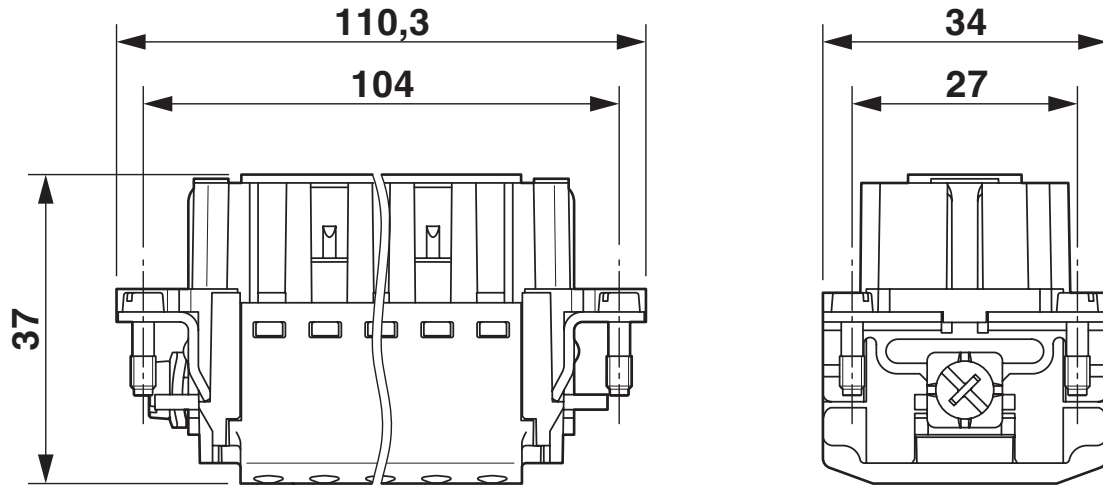

Dimensional drawing

Contact insert - HC-B24-I-PT-F



1407735

<https://www.phoenixcontact.com/pc/products/1407735>

Approvals

DNV

Approval ID: TAE000037S



CSA

Approval ID: 13631

Nominal Voltage U_N	Nominal Current I_N	Cross Section AWG	Cross Section mm^2
600 V	10 A	- 14	-



UL Recognized

Approval ID: FILE E 118976

Nominal Voltage U_N	Nominal Current I_N	Cross Section AWG	Cross Section mm^2
600 V	13 A	- 14	-



EAC

Approval ID: RU C-DE.AI30.B.01102



cULus Recognized

Approval ID: E468743

Nominal Voltage U_N	Nominal Current I_N	Cross Section AWG	Cross Section mm^2
600 V	13 A	- 14	-



EAC

Approval ID: RU C-DE.BL08.B.00511

Contact insert - HC-B24-I-PT-F



1407735

<https://www.phoenixcontact.com/pc/products/1407735>

Classifications

ECLASS

ECLASS-9.0	27440205
ECLASS-10.0.1	27440205
ECLASS-11.0	27440205

ETIM

ETIM 8.0	EC000438
----------	----------

UNSPSC

UNSPSC 21.0	39121500
-------------	----------

Contact insert - HC-B24-I-PT-F



1407735

<https://www.phoenixcontact.com/pc/products/1407735>

Environmental Product Compliance

China RoHS	Environmentally friendly use period: unlimited = EFUP-e
	No hazardous substances above threshold values

Contact insert - HC-B24-I-PT-F

1407735

<https://www.phoenixcontact.com/pc/products/1407735>



Accessories

Electrical crimping tool

Electrical crimping tool - CF CRIMPHANDY 0,5 - 1212463

<https://www.phoenixcontact.com/pc/products/1212463>



Mobile handheld device, battery-powered, for processing on-tape ferrules 0.5 mm² with functional end, suitable for PVC insulated conductors (H05V-K), incl. battery, charger, CUTFOX 12 cable cutter, waste guide plate 2, service tool for error correction, and one strip of ferrules 0.5 mm², packed in a robust case.

Electrical crimping tool

Electrical crimping tool - CF CRIMPHANDY 0,75 - 1212464

<https://www.phoenixcontact.com/pc/products/1212464>



Mobile handheld device, battery-powered, for processing on-tape ferrules 0.75 mm² with functional end, suitable for PVC insulated conductors (H05V-K), incl. battery, charger, CUTFOX 12 cable cutter, waste guide plate 2, service tool for error correction, and one strip of ferrules 0.75 mm², packed in a robust case.

Contact insert - HC-B24-I-PT-F

1407735

<https://www.phoenixcontact.com/pc/products/1407735>



Electrical crimping tool

Electrical crimping tool - CF CRIMPHANDY 1,0 - 1212465

<https://www.phoenixcontact.com/pc/products/1212465>



Mobile handheld device, battery-powered, for processing on-tape ferrules 1.0 mm² with functional end, suitable for PVC insulated conductors (H05V-K), incl. battery, charger, CUTFOX 12 cable cutter, waste guide plate 2, service tool for error correction, and one strip of ferrules 1.0 mm², packed in a robust case.

Electrical crimping tool

Electrical crimping tool - CF CRIMPHANDY 1,5 - 1212466

<https://www.phoenixcontact.com/pc/products/1212466>



Mobile handheld device, battery-powered, for processing on-tape ferrules 1.5 mm² with functional end, suitable for PVC insulated conductors (H07V-K), incl. battery, charger, CUTFOX 12 cable cutter, waste guide plate 2, service tool for error correction, and one strip of ferrules 1.5 mm², packed in a robust case.

Contact insert - HC-B24-I-PT-F

1407735

<https://www.phoenixcontact.com/pc/products/1407735>



Coding bolt

Coding bolt - HC-CB - 1772722

<https://www.phoenixcontact.com/pc/products/1772722>



Coding pin, prevents mismatching of up to six connectors with an identical number of positions

Strain relief clamp

Strain relief clamp - HC-B-ZG - 1685327

<https://www.phoenixcontact.com/pc/products/1685327>



Strain relief clamps contact inserts of series: B-, BB-, D 40, D 64, DD and HV, straight cable exit

Contact insert - HC-B24-I-PT-F

1407735

<https://www.phoenixcontact.com/pc/products/1407735>



Strain relief clamp

Strain relief clamp - HC-B-ZS - 1685330

<https://www.phoenixcontact.com/pc/products/1685330>



Strain relief clamps contact inserts of series: B-, BB-, D 40, D 64, DD and HV, lateral cable exit

Screw

Screw - HC-B-PES - 1604997

<https://www.phoenixcontact.com/pc/products/1604997>



PE screw, for contact inserts HC-B / HC-BB / HC-DD / HC-D40 / HC-D64

Contact insert - HC-B24-I-PT-F

1407735

<https://www.phoenixcontact.com/pc/products/1407735>



Contact insert

Contact insert - HC-B24-I-PT-M - 1407736

<https://www.phoenixcontact.com/pc/products/1407736>

HEAVYCON pin insert, B24 series, 24 + PE-pos., push-in connection

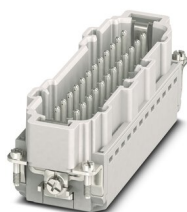

DIN rail mounting frame

DIN rail mounting frame - HC-CIF-B24-HFWL-PL - 1424337

<https://www.phoenixcontact.com/pc/products/1424337>

DIN rail mounting frame, type: B24, for contact inserts, Top frame



Contact insert - HC-B24-I-PT-F

1407735

<https://www.phoenixcontact.com/pc/products/1407735>



DIN rail mounting frame

DIN rail mounting frame - HC-CIF-B06-24-BFAFL-PL - 1424338

<https://www.phoenixcontact.com/pc/products/1424338>



DIN rail mounting frame, type: B6 - B24, for contact inserts, Base frame

Docking frames

Docking frames - HC-B 24-ANDOCK - 1586141

<https://www.phoenixcontact.com/pc/products/1586141>



Docking frame for racks, for contact inserts of B24 type, with four M5 flat headed screws, rack balance x/y axis ± 1.5 mm

Contact insert - HC-B24-I-PT-F

1407735

<https://www.phoenixcontact.com/pc/products/1407735>



Adapter

Adapter - HC-B-PE-PT - 1054672

<https://www.phoenixcontact.com/pc/products/1054672>



PE adapter with PT connection, for 1 PE connection, for HC-B / HC-BB / HC-DD / HC-D40 / HC-D64 contact inserts

Coding element

Coding element - HC-CST - 1676857

<https://www.phoenixcontact.com/pc/products/1676857>



Coding peg for coding up to 16 connectors

Contact insert - HC-B24-I-PT-F

1407735

<https://www.phoenixcontact.com/pc/products/1407735>



Coding element

Coding element - HC-CBU - 1676860

<https://www.phoenixcontact.com/pc/products/1676860>



Coding socket for coding up to 16 connectors

Coding profile

Coding profile - CP-HC - 1686478

<https://www.phoenixcontact.com/pc/products/1686478>



Coding profile, 4 coding profiles per strip, for insertion in coding keyways

Contact insert - HC-B24-I-PT-F

1407735

<https://www.phoenixcontact.com/pc/products/1407735>



PE multiplier

PE multiplier - HC-B-2PE-PT - 1054675

<https://www.phoenixcontact.com/pc/products/1054675>

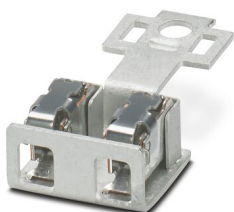

PE adapter with PT connection, for 2 PE connections, for HC-B / HC-BB / HC-DD / HC-D40 / HC-D64 contact inserts

PE multiplier

PE multiplier - HC-B-3PE - 1644326

<https://www.phoenixcontact.com/pc/products/1644326>



PE multiplier, for 3 PE connections, for HC-B / HC-BB / HC-DD / HC-D40 / HC-D64 contact inserts

Contact insert - HC-B24-I-PT-F

1407735

<https://www.phoenixcontact.com/pc/products/1407735>

Crimping pliers

Crimping pliers - CRIMPFOX CENTRUS 6S - 1213144

<https://www.phoenixcontact.com/pc/products/1213144>



Crimping pliers, for uninsulated and insulated ferrules, DIN 46228 Part 1 and 4, from 0.14 mm² ... 6 mm², also for TWIN ferrules up to 2 x 4 mm², automatic cross section adjustment, lateral insertion, equipped with fall protection

Crimping pliers

Crimping pliers - CRIMPFOX CENTRUS 10S - 1213154

<https://www.phoenixcontact.com/pc/products/1213154>



Crimping pliers, for uninsulated and insulated ferrules, DIN 46228 Part 1 and 4, from 0.14 mm² ... 10 mm², also for TWIN ferrules up to 2 x 4 mm², automatic cross section adjustment, lateral insertion, equipped with fall protection

Contact insert - HC-B24-I-PT-F

1407735

<https://www.phoenixcontact.com/pc/products/1407735>



Crimping pliers

Crimping pliers - CRIMPFOX 6 - 1212034

<https://www.phoenixcontact.com/pc/products/1212034>



Crimping pliers, for ferrules without insulating collar according to DIN 46228 Part 1 and ferrules with insulating collar according to DIN 46228 Part 4, 0.25 mm² ... 6.0 mm², lateral entry, trapezoidal crimp

Crimping pliers

Crimping pliers - CRIMPFOX 10S - 1212045

<https://www.phoenixcontact.com/pc/products/1212045>



Crimping pliers, for ferrules without insulating collar according to DIN 46228 Part 1 and ferrules with insulating collar according to DIN 46228 Part 4, 0.14 mm² ... 10 mm², unlockable pressure lock, lateral entry

Phoenix Contact 2022 © - all rights reserved
<https://www.phoenixcontact.com>

PHOENIX CONTACT GmbH & Co. KG
Flachsmarktstraße 8
D-32825 Blomberg
+49 (0) 5235-3 00
info@phoenixcontact.com