

# PCB header - MC 1,5/ 5-G-3,81

1803303

<https://www.phoenixcontact.com/de/produkte/1803303>

Please be informed that the data shown in this PDF document is generated from our Online Catalog. Please find the complete data in the user documentation. Our General Terms of Use for Downloads are valid.

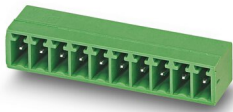

PCB headers, nominal cross section: 1.5 mm<sup>2</sup>, color: green, nominal current: 8 A, rated voltage (III/2): 160 V, contact surface: Tin, type of contact: Male connector, number of potentials: 5, number of rows: 1, number of positions: 5, number of connections: 5, product range: MC 1,5/-G, pitch: 3.81 mm, screw head form: L Slotted, pin layout: Linear pinning, solder pin [P]: 3.4 mm, number of solder pins per potential: 1, plug-in system: COMBICON MC 1,5, Pin connector pattern alignment: Standard, locking: without, mounting: without, type of packaging: packed in cardboard

## Your advantages

- Well-known mounting principle allows worldwide use
- Maximum flexibility when it comes to device design – one header for connectors with different connection technologies

# PCB header - MC 1,5/ 5-G-3,81



1803303

<https://www.phoenixcontact.com/de/produkte/1803303>

## Commercial Data

Item number	1803303
Packing unit	250 pc
Minimum order quantity	250 pc
Sales Key	E1 - Leiterplattenanschl.
Product Key	AABSBA
Catalog Page	Page 224 (C-1-2013)
GTIN	4017918045616
Weight per Piece (including packing)	1,399 g
Weight per Piece (excluding packing)	1,262 g
Customs tariff number	85366930
Country of origin	DE

## Technical Data

### Product properties

Type	Standard
Product line	COMBICON Connectors S
Product type	PCB headers
Number of positions	5
Pitch	3.81 mm
Number of connections	5
Number of rows	1
Mounting flange	without
Number of potentials	5
Pin layout	Linear pinning

### Electrical properties

Nominal current $I_N$	8 A
Nominal voltage $U_N$	160 V
Pollution degree	3
Contact resistance	1.3 mΩ
Rated voltage (III/3)	160 V
Rated surge voltage (III/3)	2.5 kV
Rated voltage (III/2)	160 V
Rated surge voltage (III/2)	2.5 kV

### Mounting

Mounting type Wave soldering	Wave soldering
Mounting type	Wave soldering
Drive form screw head	Slotted (L)

### Material specifications

#### Material data - contact

Note	WEEE/RoHS-compliant, free of whiskers according to IEC 60068-2-82/JEDEC JESD 201
Contact material	Cu alloy
Surface characteristics	Tin-plated
Metal surface contact area (top layer)	Tin (3 - 5 μm Sn)
Metal surface contact area (middle layer)	Nickel (1 - 3 μm Ni)
Metal surface soldering area (top layer)	Tin (3 - 5 μm Sn)
Metal surface soldering area (middle layer)	Nickel (1 - 3 μm Ni)

#### Material data - housing

Housing color	green (6021)
Insulating material	PBT
Insulating material group	IIIa

# PCB header - MC 1,5/ 5-G-3,81

1803303

<https://www.phoenixcontact.com/de/produkte/1803303>

CTI according to IEC 60112	225
Flammability rating according to UL 94	V0

## Dimensions

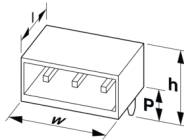
Dimensional drawing	
Pitch	3.81 mm
Width [w]	20.44 mm
Height [h]	10.65 mm
Length [l]	9.2 mm
Installed height	7.25 mm
Solder pin length [P]	3.4 mm

## Mechanical tests

### Test for conductor damage and slackening

Specification	IEC 60999-1:1999-11
Result	Test passed

### Pull-out test

Specification	IEC 60999-1:1999-11
Conductor cross section/conductor type/tractive force setpoint/actual value	0.14 mm <sup>2</sup> / solid / > 7 N
	0.14 mm <sup>2</sup> / flexible / > 7 N
	1.5 mm <sup>2</sup> / solid / > 40 N
	1.5 mm <sup>2</sup> / flexible / > 40 N

### Insertion and withdrawal forces

Result	Test passed
No. of cycles	25
Insertion strength per pos. approx.	6 N
Withdraw strength per pos. approx.	4 N

### Torque test

Specification	IEC 60999-1:1999-11
---------------	---------------------

### Contact holder in insert

Specification	IEC 60512-15-1:2008-05
Contact holder in insert Requirements >20 N	Test passed

### Resistance of inscriptions

Specification	IEC 60068-2-70:1995-12
Result	Test passed

1803303

<https://www.phoenixcontact.com/de/produkte/1803303>

## Polarization and coding

Specification	IEC 60512-13-5:2006-02
Result	Test passed

## Visual inspection

Specification	IEC 60512-1-1:2002-02
Result	Test passed

## Dimension check

Specification	IEC 60512-1-2:2002-02
Result	Test passed

## Electrical tests

### Thermal test | Test group C

Specification	IEC 60512-5-1:2002-02
Tested number of positions	20

### Insulation resistance

Specification	IEC 60512-3-1:2002-02
Insulation resistance, neighboring positions	> 5 MΩ

### Air clearances and creepage distances |

Specification	IEC 60664-1:2007-04
Insulating material group	IIIa
Comparative tracking index (IEC 60112)	CTI 225
Rated insulation voltage (III/3)	160 V
Rated surge voltage (III/3)	2.5 kV
minimum clearance value - non-homogenous field (III/3)	1.5 mm
minimum creepage distance (III/3)	2.5 mm
Rated insulation voltage (III/2)	160 V
Rated surge voltage (III/2)	2.5 kV
minimum clearance value - non-homogenous field (III/2)	1.5 mm
minimum creepage distance (III/2)	1.6 mm
Rated insulation voltage (II/2)	250 V
Rated surge voltage (II/2)	2.5 kV
minimum clearance value - non-homogenous field (II/2)	1.5 mm
minimum creepage distance (II/2)	2.5 mm

## Environmental and real-life conditions

### Vibration test

Specification	IEC 60068-2-6:2007-12
Frequency	10 - 150 - 10 Hz
Sweep speed	1 octave/min
Amplitude	0.35 mm (10 - 60.1 Hz)

# PCB header - MC 1,5/ 5-G-3,81



1803303

<https://www.phoenixcontact.com/de/produkte/1803303>

Sweep speed	5g (60.1 - 150 Hz)
Test duration per axis	2.5 h

## Durability test

Specification	IEC 60512-9-1:2010-03
Impulse withstand voltage at sea level	2.95 kV
Contact resistance R <sub>1</sub>	1.3 mΩ
Contact resistance R <sub>2</sub>	1.5 mΩ
Insertion/withdrawal cycles	25
Insulation resistance, neighboring positions	> 5 MΩ

## Climatic test

Specification	ISO 6988:1985-02
Corrosive stress	0.2 dm <sup>3</sup> SO <sub>2</sub> on 300 dm <sup>3</sup> /40 °C/1 cycle
Thermal stress	100 °C/168 h
Power-frequency withstand voltage	1.39 kV

## Ambient conditions

Ambient temperature (operation)	-40 °C ... 100 °C (dependent on the derating curve)
Ambient temperature (storage/transport)	-40 °C ... 70 °C
Relative humidity (storage/transport)	30 % ... 70 %
Ambient temperature (assembly)	-5 °C ... 100 °C

## Packaging specifications

Type of packaging	packed in cardboard
-------------------	---------------------

Drawings

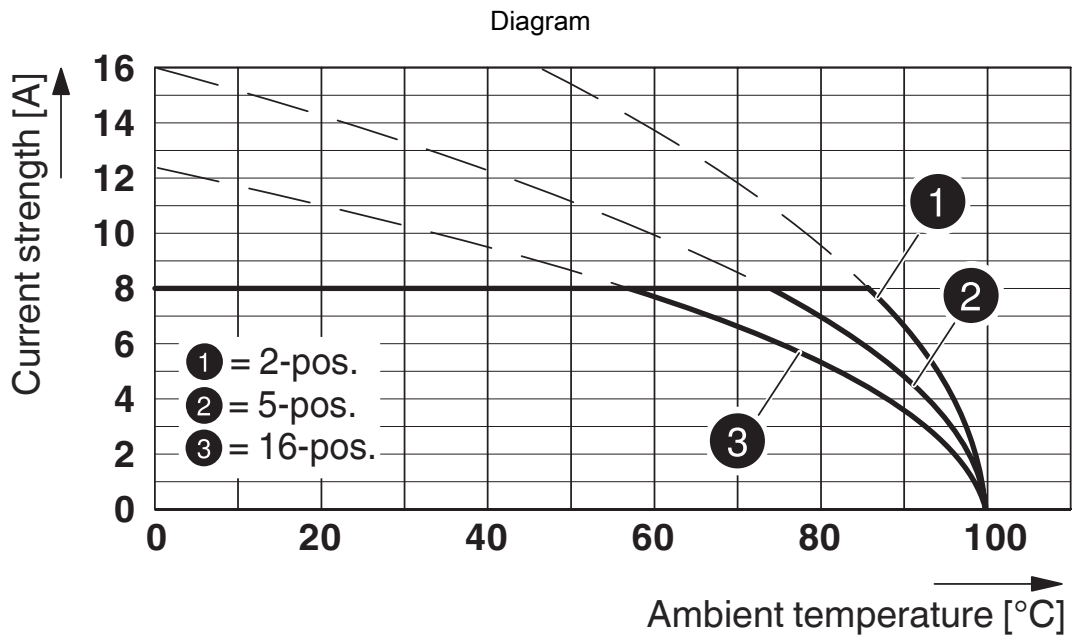

Type: IMC 1,5/...-G-3,81 with MC 1,5/...-G-3,81

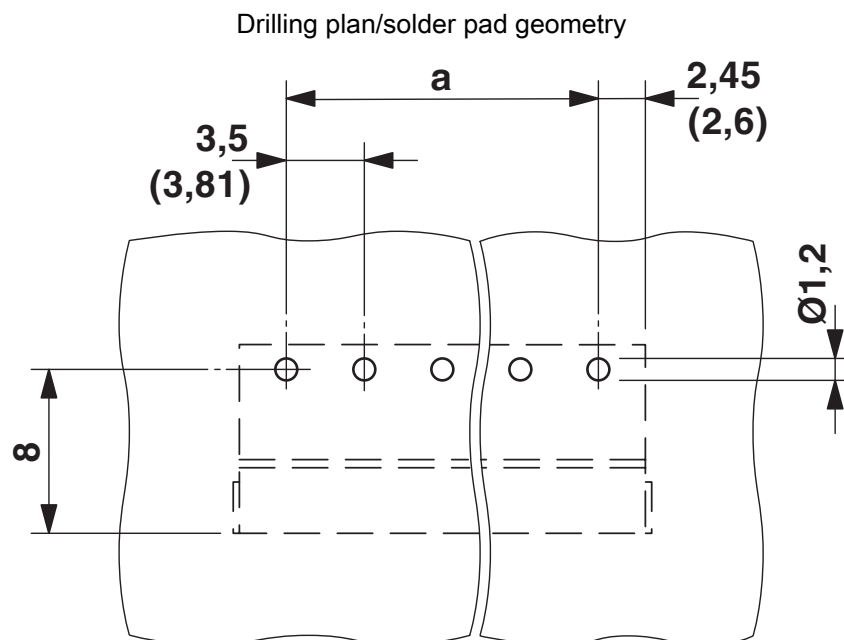

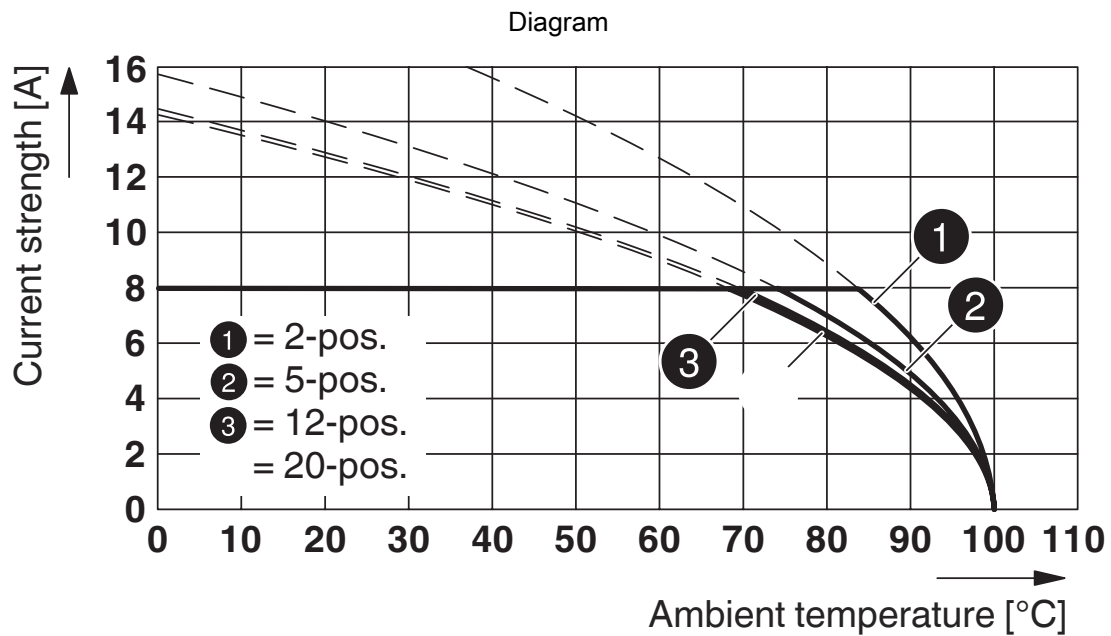

Type: FMC 1,5/...-ST-3,81 with MC 1,5/...-G-3,81

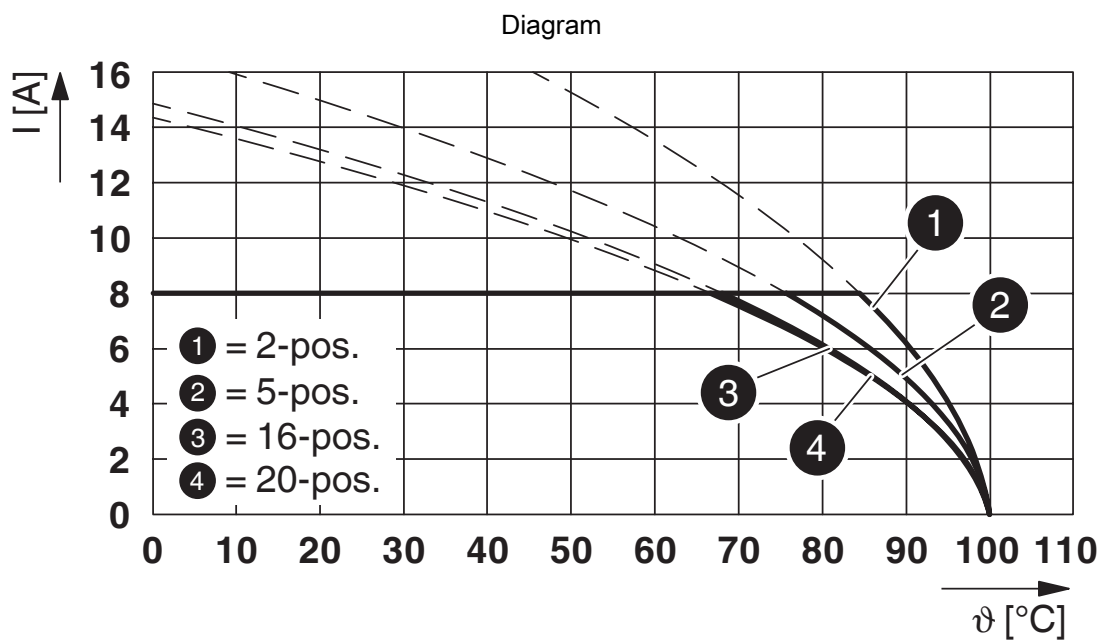

Type: FRONT-MC 1,5/...-ST-3,81 with MC 1,5/...-G-3,81



1803303

<https://www.phoenixcontact.com/de/produkte/1803303>

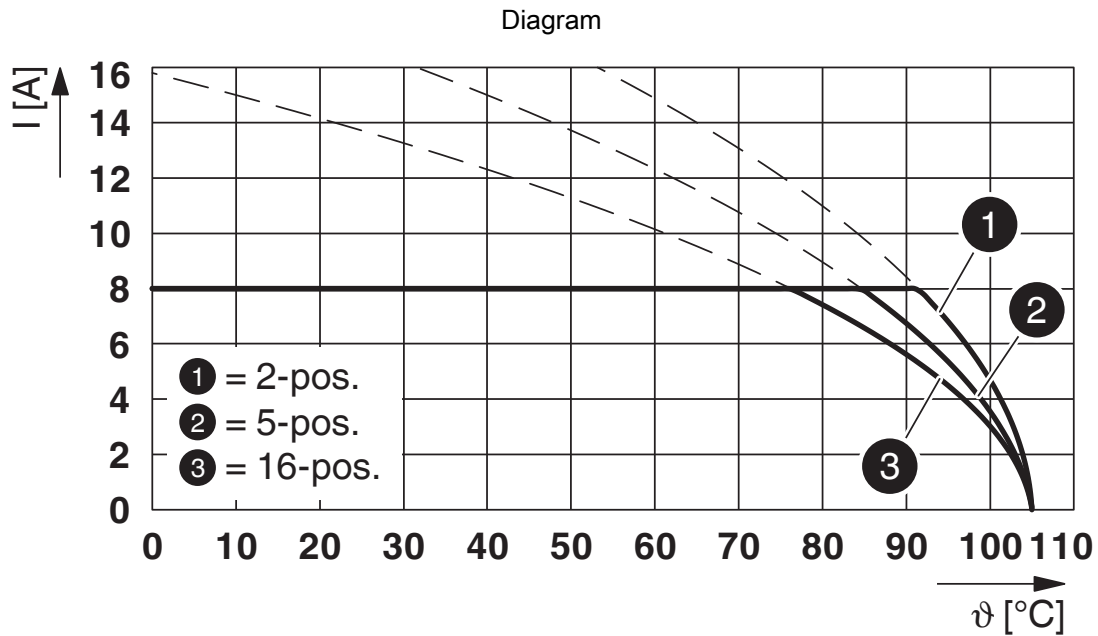

Type: LPC 1,5/...-ST-3,81 with MC 1,5/...-G-3,81

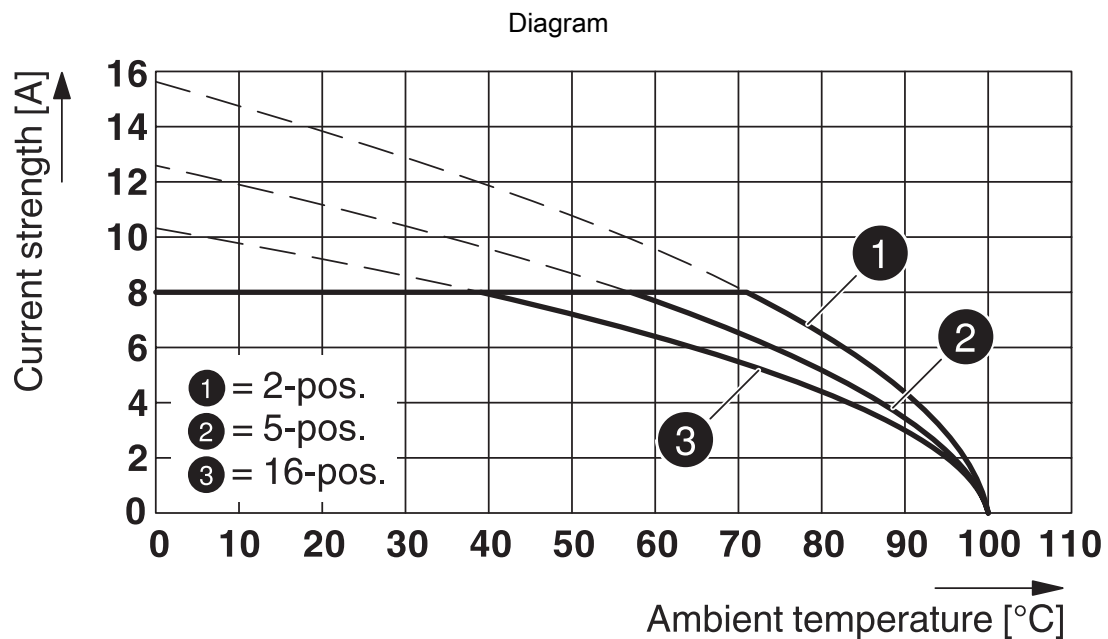

Type: MCVW 1,5/...-ST-3,81 with MC 1,5/...-G-3,81

# PCB header - MC 1,5/ 5-G-3,81

1803303

<https://www.phoenixcontact.com/de/produkte/1803303>

Dimensional drawing

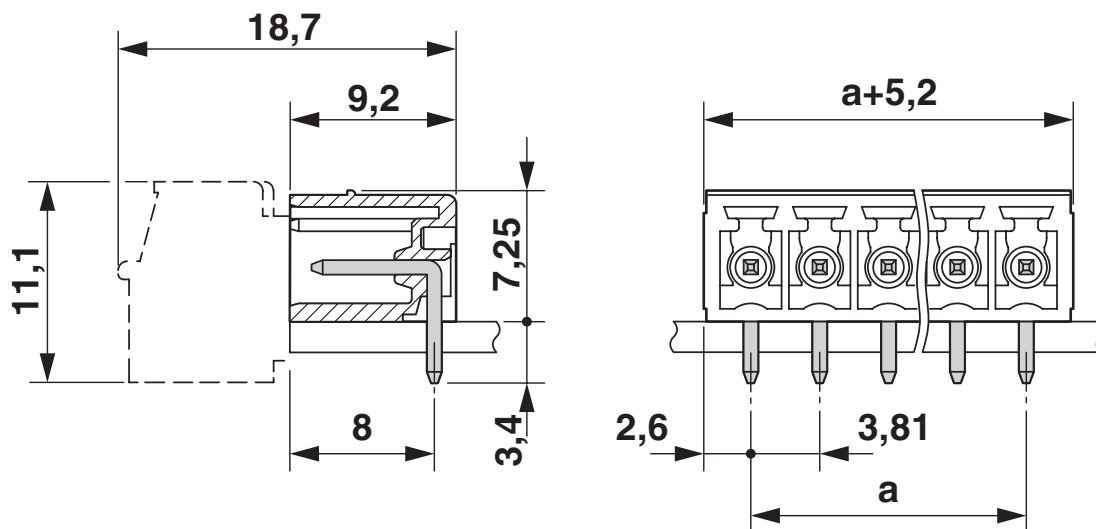

Diagram

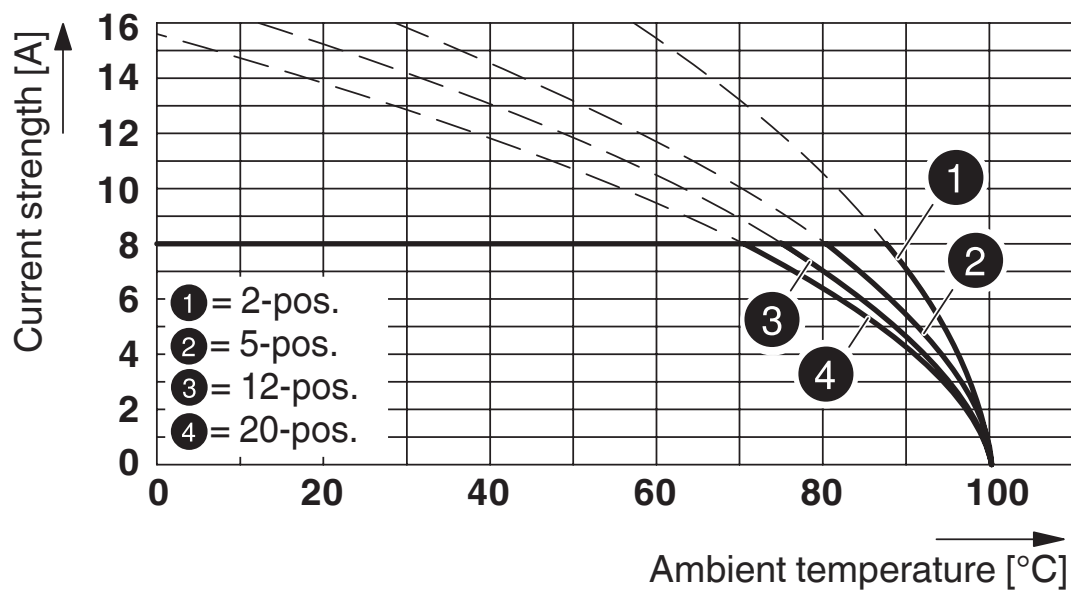

Type: MC 1,5/...-ST-3,81 with MC 1,5/...-G-3,81

# PCB header - MC 1,5/ 5-G-3,81



1803303

<https://www.phoenixcontact.com/de/produkte/1803303>

## Approvals

 <b>CSA</b> Approval ID: 13631				
	Nominal Voltage $U_N$	Nominal Current $I_N$	Cross Section AWG	Cross Section $\text{mm}^2$
Use group B	300 V	8 A	-	-
Use group D	300 V	8 A	-	-

 <b>IECEE CB Scheme</b> Approval ID: DE1-60987-B1B2				
	Nominal Voltage $U_N$	Nominal Current $I_N$	Cross Section AWG	Cross Section $\text{mm}^2$
	160 V	8 A	-	-

 <b>EAC</b> Approval ID: B.01687				
--	--	--	--	--

 <b>cULus Recognized</b> Approval ID: E60425-20110128				
	Nominal Voltage $U_N$	Nominal Current $I_N$	Cross Section AWG	Cross Section $\text{mm}^2$
Use group B	300 V	8 A	-	-
Use group D	300 V	8 A	-	-

 <b>VDE report with production monitoring</b> Approval ID: 40011723				
	Nominal Voltage $U_N$	Nominal Current $I_N$	Cross Section AWG	Cross Section $\text{mm}^2$
	160 V	8 A	-	-

# PCB header - MC 1,5/ 5-G-3,81



1803303

<https://www.phoenixcontact.com/de/produkte/1803303>

## Classifications

### ECLASS

ECLASS-9.0	27440402
ECLASS-10.0.1	27440402
ECLASS-11.0	27460201

### ETIM

ETIM 8.0	EC002637
----------	----------

### UNSPSC

UNSPSC 21.0	39121400
-------------	----------

# PCB header - MC 1,5/ 5-G-3,81

1803303

<https://www.phoenixcontact.com/de/produkte/1803303>



## Environmental Product Compliance

China RoHS	Environmentally friendly use period: unlimited = EFUP-e
	No hazardous substances above threshold values

# PCB header - MC 1,5/ 5-G-3,81

1803303

<https://www.phoenixcontact.com/de/produkte/1803303>



## Accessories

### Marker card

Marker card - SK 3,81/2,8:FORTL.ZAHLEN - 0804109

<https://www.phoenixcontact.com/de/produkte/0804109>

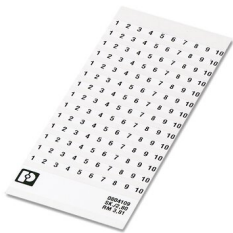

Marker card, white, labeled, horizontal: consecutive numbers 1 ... 10, 11 ... 20, etc. up to 91 ... (99)100, mounting type: adhesive, for terminal block width: 3.81 mm, lettering field size: 3.81 x 2.8 mm

---

### Fiber optic

Fiber optic - MC 1,5/10-LWL 1,5-3,81 - 1841174

<https://www.phoenixcontact.com/de/produkte/1841174>



MINI COMBICON fiber optics, 3.81 mm pitch, 10-pos., separable for other numbers of positions (minimum: 2-pos.), inserts into the back of the MC header, color: transparent, dimension a: 1.5 mm

# PCB header - MC 1,5/ 5-G-3,81

1803303

<https://www.phoenixcontact.com/de/produkte/1803303>

## Fiber optic

Fiber optic - MC 1,5/10-LWL 2,3-3,81 - 1841190

<https://www.phoenixcontact.com/de/produkte/1841190>

MINI COMBICON fiber optics, 3.81 mm pitch, 10-pos., separable for other numbers of positions (minimum: 2-pos.), inserts into the back of the MC header, color: transparent, dimension a: 2.3 mm



---

## Fiber optic

Fiber optic - MC 1,5/10-LWL 4-3,81 - 1841213

<https://www.phoenixcontact.com/de/produkte/1841213>

MINI COMBICON fiber optics, 3.81 mm pitch, 10-pos., separable for other numbers of positions (minimum: 2-pos.), inserts into the back of the MC header, color: transparent, dimension a: 4 mm



# PCB header - MC 1,5/ 5-G-3,81

1803303

<https://www.phoenixcontact.com/de/produkte/1803303>



## Marker pen

Marker pen - B-STIFT - 1051993

<https://www.phoenixcontact.com/de/produkte/1051993>



Marker pen, for manual labeling of unprinted Zack strips, smear-proof and waterproof, line thickness 0.5 mm

---

## Printed-circuit board connector

Printed-circuit board connector - FMC 1,5/ 5-ST-3,81 - 1745920

<https://www.phoenixcontact.com/de/produkte/1745920>

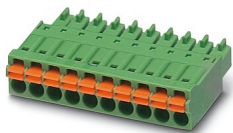

PCB connector, nominal cross section: 1.5 mm<sup>2</sup>, color: green, nominal current: 8 A, rated voltage (III/2): 160 V, contact surface: Tin, type of contact: Female connector, number of potentials: 5, number of rows: 1, number of positions: 5, number of connections: 5, product range: FMC 1,5/..-ST, pitch: 3.81 mm, connection method: Push-in spring connection, conductor/PCB connection direction: 0 °, number of solder pins per potential: 1, plug-in system: COMBICON MC 1,5, locking: without, mounting: without, type of packaging: packed in cardboard



# PCB header - MC 1,5/ 5-G-3,81

1803303

<https://www.phoenixcontact.com/de/produkte/1803303>

## PCB connector

PCB connector - MC 1,5/ 5-ST-3,81 - 1803604

<https://www.phoenixcontact.com/de/produkte/1803604>



PCB connector, nominal cross section: 1.5 mm<sup>2</sup>, color: green, nominal current: 8 A, rated voltage (III/2): 160 V, contact surface: Tin, type of contact: Female connector, number of potentials: 5, number of rows: 1, number of positions: 5, number of connections: 5, product range: MC 1,5/..-ST, pitch: 3.81 mm, connection method: Screw connection with tension sleeve, screw head form: L Slotted, conductor/PCB connection direction: 0 °, number of solder pins per potential: 1, plug-in system: COMBICON MC 1,5, locking: without, mounting: without, type of packaging: packed in cardboard

## PCB connector

PCB connector - MCVW 1,5/ 5-ST-3,81 - 1827004

<https://www.phoenixcontact.com/de/produkte/1827004>

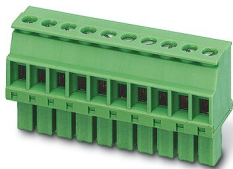

PCB connector, nominal cross section: 1.5 mm<sup>2</sup>, color: green, nominal current: 8 A, rated voltage (III/2): 160 V, contact surface: Tin, type of contact: Female connector, number of potentials: 5, number of rows: 1, number of positions: 5, number of connections: 5, product range: MCVW 1,5/..-ST, pitch: 3.81 mm, connection method: Screw connection with tension sleeve, screw head form: L Slotted, conductor/PCB connection direction: -90 °, number of solder pins per potential: 1, plug-in system: COMBICON MC 1,5, locking: without, mounting: without, type of packaging: packed in cardboard

# PCB header - MC 1,5/ 5-G-3,81

1803303

<https://www.phoenixcontact.com/de/produkte/1803303>



## PCB connector

PCB connector - MCVR 1,5/ 5-ST-3,81 - 1827156

<https://www.phoenixcontact.com/de/produkte/1827156>

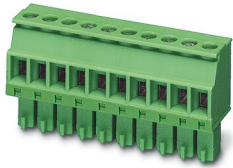

PCB connector, nominal cross section: 1.5 mm<sup>2</sup>, color: green, nominal current: 8 A, rated voltage (III/2): 160 V, contact surface: Tin, type of contact: Female connector, number of potentials: 5, number of rows: 1, number of positions: 5, number of connections: 5, product range: MCVR 1,5/...-ST, pitch: 3.81 mm, connection method: Screw connection with tension sleeve, screw head form: L Slotted, conductor/PCB connection direction: 90 °, number of solder pins per potential: 1, plug-in system: COMBICON MC 1,5, locking: without, mounting: without, type of packaging: packed in cardboard

---

## Printed-circuit board connector

Printed-circuit board connector - FRONT-MC 1,5/ 5-ST-3,81 - 1850699

<https://www.phoenixcontact.com/de/produkte/1850699>

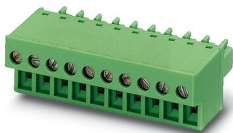

PCB connector, nominal cross section: 1.5 mm<sup>2</sup>, color: green, nominal current: 8 A, rated voltage (III/2): 160 V, contact surface: Tin, type of contact: Female connector, number of potentials: 5, number of rows: 1, number of positions: 5, number of connections: 5, product range: FRONT-MC 1,5/...-ST, pitch: 3.81 mm, connection method: Front screw connection, screw head form: L Slotted, conductor/PCB connection direction: 0 °, number of solder pins per potential: 1, plug-in system: COMBICON MC 1,5, locking: without, mounting: without, type of packaging: packed in cardboard

# PCB header - MC 1,5/ 5-G-3,81

1803303

<https://www.phoenixcontact.com/de/produkte/1803303>

## PCB connector

PCB connector - FK-MCP 1,5/ 5-ST-3,81 - 1851070

<https://www.phoenixcontact.com/de/produkte/1851070>

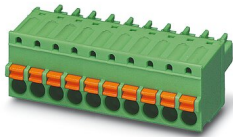

PCB connector, nominal cross section: 1.5 mm<sup>2</sup>, color: green, nominal current: 8 A, rated voltage (III/2): 160 V, contact surface: Tin, type of contact: Female connector, number of potentials: 5, number of rows: 1, number of positions: 5, number of connections: 5, product range: FK-MCP 1,5/...-ST, pitch: 3.81 mm, connection method: Push-in spring connection, conductor/PCB connection direction: 0 °, number of solder pins per potential: 1, plug-in system: COMBICON MC 1,5, locking: without, mounting: without, type of packaging: packed in cardboard

---

## PCB connector

PCB connector - MCC 1/ 5-STZ-3,81 - 1852202

<https://www.phoenixcontact.com/de/produkte/1852202>



PCB connector, nominal cross section: 1 mm<sup>2</sup>, color: green, nominal current: 8 A, rated voltage (III/2): 160 V, type of contact: Female connector, number of potentials: 5, number of rows: 1, number of positions: 5, number of connections: 5, product range: MCC 1/...-STZ, pitch: 3.81 mm, connection method: Crimp connection, conductor/PCB connection direction: 0 °, number of solder pins per potential: 1, plug-in system: COMBICON MC 1,5, locking: without, mounting: without, type of packaging: packed in cardboard, Corresponding female crimp contacts with current [A] and conductor cross section range [mm<sup>2</sup>] data: 5A/MCC-MT 0,2-0,35 (1859988); 8A/MCC-MT 0,5-1,0 (1859991)

# PCB header - MC 1,5/ 5-G-3,81

1803303

<https://www.phoenixcontact.com/de/produkte/1803303>



## Printed-circuit board connector

Printed-circuit board connector - QC 0,5/ 5-ST-3,81 - 1897429

<https://www.phoenixcontact.com/de/produkte/1897429>

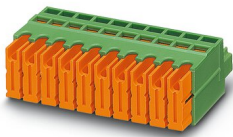

PCB connector, nominal cross section: 0.5 mm<sup>2</sup>, color: green, nominal current: 6 A, rated voltage (III/2): 200 V, contact surface: Tin, type of contact: Female connector, number of potentials: 5, number of rows: 1, number of positions: 5, number of connections: 5, product range: QC 0,5/...-ST, pitch: 3.81 mm, connection method: Displacement connection, conductor/PCB connection direction: 0 °, number of solder pins per potential: 1, plug-in system: COMBICON MC 1,5, locking: without, mounting: without, type of packaging: packed in cardboard

---

Phoenix Contact 2022 © - all rights reserved

<https://www.phoenixcontact.com>

PHOENIX CONTACT Deutschland GmbH

Flachsmarktstraße 8

D-32825 Blomberg

+49 52 35/3-1 20 00

[info@phoenixcontact.de](mailto:info@phoenixcontact.de)