

Electronic circuit breaker - CB E1 24DC/4A NO P



2800904

<https://www.phoenixcontact.com/de/produkte/2800904>

Please be informed that the data shown in this PDF document is generated from our Online Catalog. Please find the complete data in the user documentation. Our General Terms of Use for Downloads are valid.

Electronic circuit breaker, 1-pos., active current limitation, 1 N/O contact, plug for base element.



Your advantages

- Individually adjustable with protective plugs
- Protective plug with fixed nominal current value as protection against unintentional changes
- Active current limitation to improve the capacity of the upstream power supply
- Increased system transparency with integrated remote message function

Electronic circuit breaker - CB E1 24DC/4A NO P



2800904

<https://www.phoenixcontact.com/de/produkte/2800904>

Commercial Data

Item number	2800904
Packing unit	1 pc
Minimum order quantity	1 pc
Note	Made to Order (non-returnable)
Sales Key	L1 - Schutzschalter
Product Key	CLA134
Catalog Page	Page 382 (C-4-2019)
GTIN	4046356690744
Weight per Piece (including packing)	35,2 g
Weight per Piece (excluding packing)	35,2 g
Customs tariff number	85362010
Country of origin	DE

Electronic circuit breaker - CB E1 24DC/4A NO P



2800904

<https://www.phoenixcontact.com/de/produkte/2800904>

Technical Data

Notes

General	When mounted in rows without convection cooling, the nominal device current should only be led to a maximum of 80% due to the thermal effect during continuous operation (100% operating factor). Special precautionary measures must be taken in systems or machines, to prevent components from restarting (e.g., use of a safety PLC). Parallel connection of multiple circuit breakers is not permitted.
---------	--

Product properties

Type	Male
Product type	Device circuit breakers
Number of positions	1
No. of channels	1

Insulation characteristics

Degree of pollution	2
---------------------	---

Electrical properties

No. of channels	1
Operating voltage	24 V DC
Operating voltage	18 V DC ... 30 V DC
Nominal current I_N	4 A
Rated surge voltage	0.5 kV
Tripping method	E (electronic)
Required backup fuse	not required, integrated failsafe element
Dielectric strength	max. 30 V DC (Load circuit)
Active current limitation	typ. $1.25 \times I_N$
Fuse	electronic
Closed circuit current I_0	typ. 8 mA (When switched on) typ. 17 mA (With alarm output)
Power dissipation	0.81 W (Nominal operation)
Temperature derating	4 A (at 50 °C)
Voltage drop	100 mV (at I_N)
Shutdown time	200 ms (see time/current characteristic curve)
Undervoltage switch-off	< 14 V (typ. OFF) > 17 V (typ. ON)
Max. capacitive load	20000 μ F
Type of contact	floating signal contact
Minimum operating voltage U_{min} DC	10 V DC
Maximum operating voltage U_{max} DC	30 V DC
Minimum operating current I_{min}	10 mA
Max. operating current I_{max}	0.5 A

Electronic circuit breaker - CB E1 24DC/4A NO P



2800904

<https://www.phoenixcontact.com/de/produkte/2800904>

Dimensions

Dimensional drawing	
Width	12.3 mm
Width	12.3 mm
Height	45 mm
Height	45 mm
Depth	52 mm
Depth	52 mm
Complete module width	12.3 mm
Complete module height	90 mm
Complete module depth	77.3 mm

Material specifications

Color	gray
Flammability rating according to UL 94	V-0

Environmental and real-life conditions

Ambient conditions

Degree of protection	IP30 (Actuation area)
Ambient temperature (operation)	-25 °C ... 50 °C (non-condensing)
Ambient temperature (storage/transport)	-40 °C ... 70 °C
Humidity test	96 h, 95 % RH, 40 °C
Vibration (operation)	3g (according to IEC 60068-2-6, Test Fc)

Approval data

UL approval

Identification	UL Listed UL 508
	UL Recognized UL 2367

UL approval

Identification	DNV GL
----------------	--------

Standards and regulations

Standards/specifications	EN 61000-6-3
Standards/specifications	EN 61000-6-2

Mounting

Mounting type	on base element
---------------	-----------------

Electronic circuit breaker - CB E1 24DC/4A NO P

2800904

<https://www.phoenixcontact.com/de/produkte/2800904>

Drawings

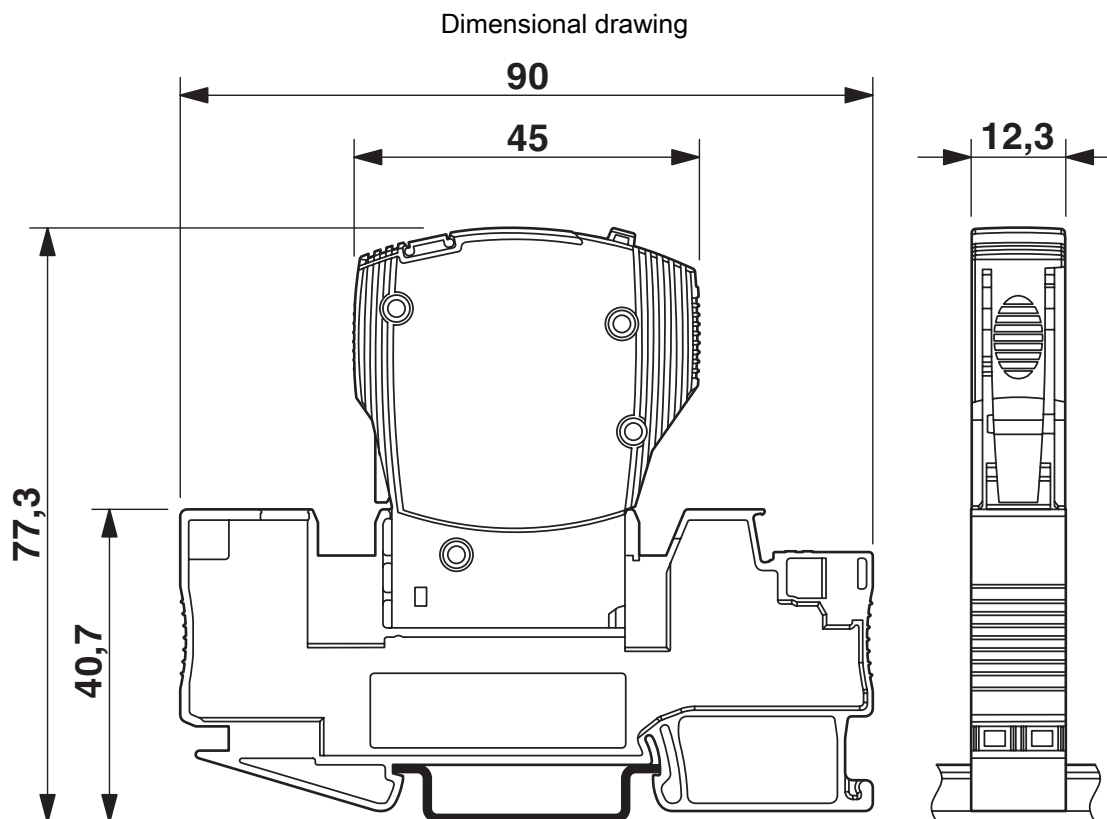

The figure shows the complete module consisting of a base element and connector

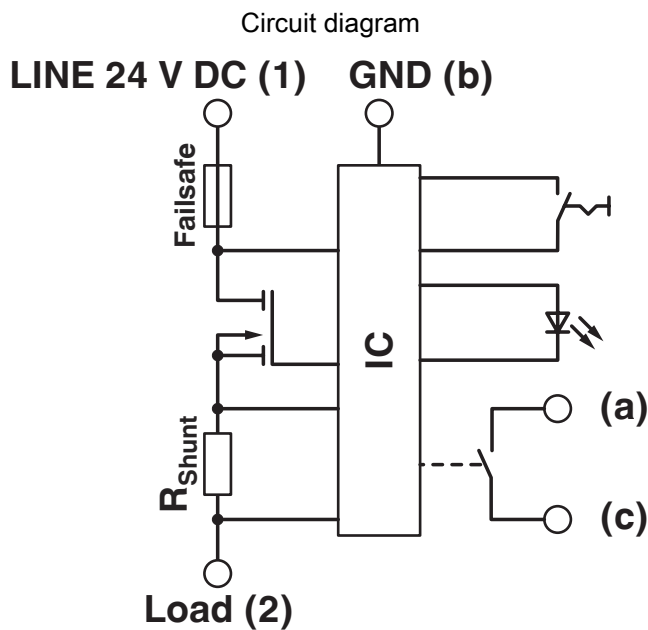

Electronic circuit breaker - CB E1 24DC/4A NO P

2800904

<https://www.phoenixcontact.com/de/produkte/2800904>

Application drawing

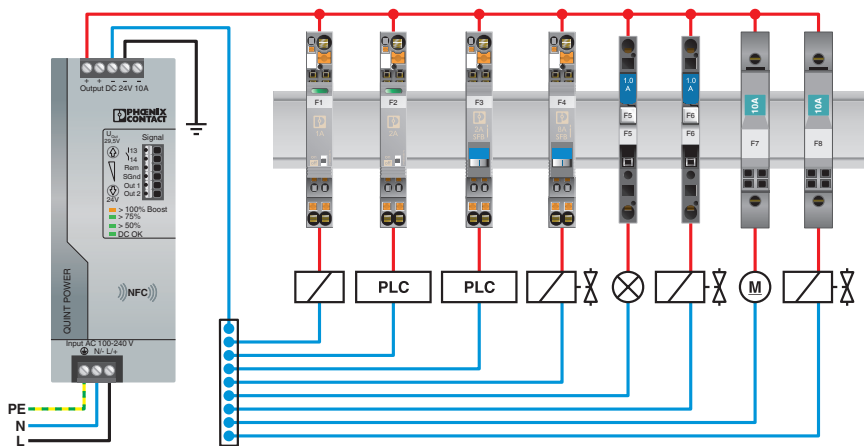

Diagram

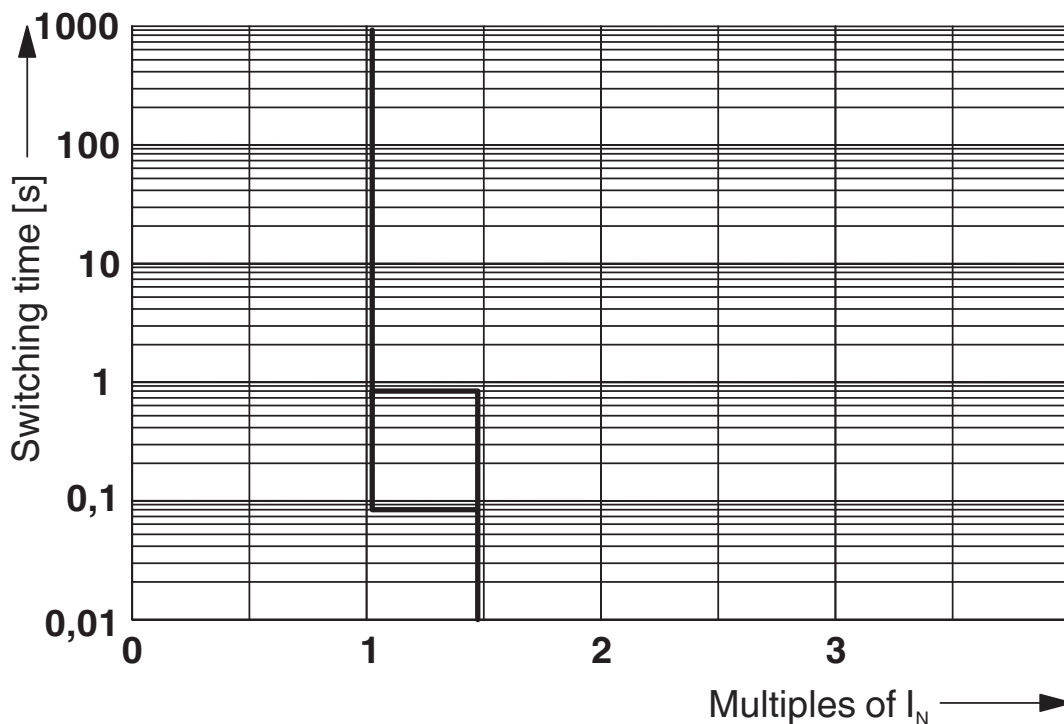

Trigger characteristic

Electronic circuit breaker - CB E1 24DC/4A NO P



2800904

<https://www.phoenixcontact.com/de/produkte/2800904>

Approvals



UL Recognized

Approval ID: FILE E 317172



DNV GL

Approval ID: TAE00003KA



UL Listed

Approval ID: FILE E 140324



cUL Listed

Approval ID: FILE E 140324

cULus Listed

Electronic circuit breaker - CB E1 24DC/4A NO P



2800904

<https://www.phoenixcontact.com/de/produkte/2800904>

Classifications

ECLASS

ECLASS-9.0	27141116
ECLASS-10.0.1	27140401
ECLASS-11.0	27140401

ETIM

ETIM 8.0	EC003538
----------	----------

UNSPSC

UNSPSC 21.0	39121400
-------------	----------

Electronic circuit breaker - CB E1 24DC/4A NO P



2800904

<https://www.phoenixcontact.com/de/produkte/2800904>

Environmental Product Compliance

REACH SVHC	Lead 7439-92-1
China RoHS	Environmentally Friendly Use Period = 25;
	For information on hazardous substances, refer to the manufacturer's declaration available under "Downloads"

Electronic circuit breaker - CB E1 24DC/4A NO P

2800904

<https://www.phoenixcontact.com/de/produkte/2800904>

Mandatory Accessories

Base element

Base element - CB 1/6-2/4 PT-BE - 2800929

<https://www.phoenixcontact.com/de/produkte/2800929>

Base element with push-in connection technology for CB ... device circuit breakers

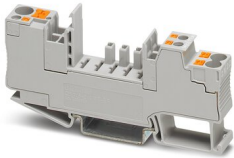

Base element

Base element - CB 1/10-1/10 UT-BE - 2801305

<https://www.phoenixcontact.com/de/produkte/2801305>

Base element with screw connection technology for CB... device circuit breakers

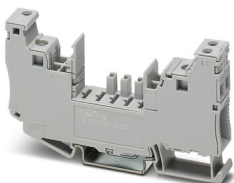

Accessories

Electronic circuit breaker - CB E1 24DC/4A NO P

2800904

<https://www.phoenixcontact.com/de/produkte/2800904>

Bridge

Bridge - CB PT BRIDGE - 2801014

<https://www.phoenixcontact.com/de/produkte/2801014>



Bridge plug for bridging contacts 1 to 2 for CB base elements

Bridge

Bridge - CB RC BRIDGE - 2801616

<https://www.phoenixcontact.com/de/produkte/2801616>



Bridge plug for bridging contacts 11 to 14 for CB base elements

Electronic circuit breaker - CB E1 24DC/4A NO P

2800904

<https://www.phoenixcontact.com/de/produkte/2800904>

Plug-in bridge

Plug-in bridge - FBS 2-6 - 3030336

<https://www.phoenixcontact.com/de/produkte/3030336>



Plug-in bridge, pitch: 6.2 mm, color: red

Plug-in bridge

Plug-in bridge - FBS 3-6 - 3030242

<https://www.phoenixcontact.com/de/produkte/3030242>



Plug-in bridge, pitch: 6.2 mm, color: red

Electronic circuit breaker - CB E1 24DC/4A NO P

2800904

<https://www.phoenixcontact.com/de/produkte/2800904>

Plug-in bridge

Plug-in bridge - FBS 4-6 - 3030255

<https://www.phoenixcontact.com/de/produkte/3030255>



Plug-in bridge, pitch: 6.2 mm, color: red

Plug-in bridge

Plug-in bridge - FBS 5-6 - 3030349

<https://www.phoenixcontact.com/de/produkte/3030349>



Plug-in bridge, pitch: 6.2 mm, color: red

Electronic circuit breaker - CB E1 24DC/4A NO P

2800904

<https://www.phoenixcontact.com/de/produkte/2800904>

Plug-in bridge

Plug-in bridge - FBS 10-6 - 3030271

<https://www.phoenixcontact.com/de/produkte/3030271>



Plug-in bridge, pitch: 6.2 mm, color: red

Plug-in bridge

Plug-in bridge - FBS 20-6 - 3030365

<https://www.phoenixcontact.com/de/produkte/3030365>



Plug-in bridge, pitch: 6.2 mm, color: red

Electronic circuit breaker - CB E1 24DC/4A NO P



2800904

<https://www.phoenixcontact.com/de/produkte/2800904>

Plug-in bridge

Plug-in bridge - FBS 50-6 - 3032224

<https://www.phoenixcontact.com/de/produkte/3032224>



Plug-in bridge, pitch: 6.2 mm, color: red

Front cutter

Front cutter - CUTFOX-FBS - 1212124

<https://www.phoenixcontact.com/de/produkte/1212124>



Cutting tool, for separating individual jumper bars from FBS ... plug-in bridges and EB ... insertion bridges

Electronic circuit breaker - CB E1 24DC/4A NO P



2800904

<https://www.phoenixcontact.com/de/produkte/2800904>

Zack Marker strip, flat

Zack Marker strip, flat - ZBF 12:UNBEDRUCKT - 0809735

<https://www.phoenixcontact.com/de/produkte/0809735>



Zack Marker strip, flat, Strip, white, unlabeled, can be labeled with: PLOTMARK, CMS-P1-PLOTTER, mounting type: snapped, for terminal block width: 12 mm, lettering field size: 5.15 x 12.15 mm, Number of individual labels: 5

Zack Marker strip, flat

Zack Marker strip, flat - ZBF 12 CUS - 0825018

<https://www.phoenixcontact.com/de/produkte/0825018>



Zack Marker strip, flat, can be ordered: Strip, white, labeled according to customer specifications, mounting type: snap into flat marker groove, for terminal block width: 12 mm, lettering field size: 5.15 x 12.15 mm, Number of individual labels: 5

Phoenix Contact 2022 © - all rights reserved
<https://www.phoenixcontact.com>

PHOENIX CONTACT Deutschland GmbH
Flachsmarktstraße 8
D-32825 Blomberg
+49 52 35/3-1 20 00
info@phoenixcontact.de