

Cable sleeve - CES-STPG-GY-2X9



1410440

<https://www.phoenixcontact.com/pc/products/1410440>

Please be informed that the data shown in this PDF document is generated from our Online Catalog. Please find the complete data in the user documentation. Our General Terms of Use for Downloads are valid.

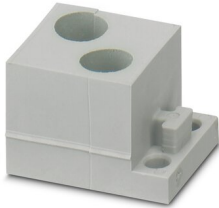

Cable sleeve, small, no. of conductors: 2, type: Round cable, slotted, external cable diameter: 2x 8.4 mm ... 8.7 mm, material: SEBS (halogen-free), color: gray, length: 29.5 mm, width: 19.5 mm, height: 17 mm

Product Description

Slotted cable sleeve

Commercial Data

Item number	1410440
Packing unit	10 pc
Minimum order quantity	1 pc
Product Key	BF7CCX
Catalog Page	Page 681 (C-2-2019)
GTIN	4046356776271
Weight per Piece (including packing)	6.07 g
Weight per Piece (excluding packing)	6.07 g
Customs tariff number	40169997
Country of origin	PL

Cable sleeve - CES-STPG-GY-2X9

1410440

<https://www.phoenixcontact.com/pc/products/1410440>

Technical Data

Product properties

Product type	Cable sleeve
No. of conductors	2

Dimensions

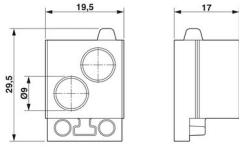
Dimensional drawing	
Width	19.5 mm
Height	17 mm
Length	29.5 mm

Material specifications

Color	gray
Material	SEBS
Material	SEBS (halogen-free)
Flammability rating according to UL 94	V0

Cable / line

External cable diameter	2x 8.4 mm ... 8.7 mm
-------------------------	----------------------

Characteristics

Seal size	small
Design, Format	Round cable
Design, Cable seal	slotted

Environmental and real-life conditions

Ambient conditions

Degree of protection	IP54
Ambient temperature (operation)	-40 °C ... 80 °C (static)

Cable sleeve - CES-STPG-GY-2X9

1410440

<https://www.phoenixcontact.com/pc/products/1410440>



Drawings

Dimensional drawing

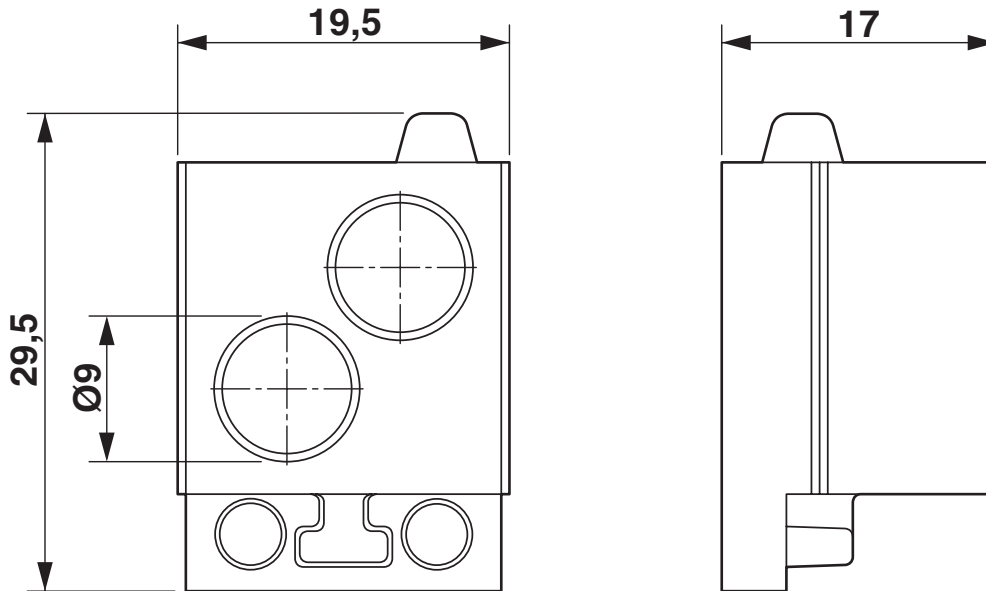

Dimensional drawing

Cable sleeve - CES-STPG-GY-2X9



1410440

<https://www.phoenixcontact.com/pc/products/1410440>

Approvals



cUL Recognized

Approval ID: NITW8.E255026



UL Recognized

Approval ID: NITW2.E255026

DNV

Approval ID: TAE00003VJ

cULus Recognized

Cable sleeve - CES-STPG-GY-2X9



1410440

<https://www.phoenixcontact.com/pc/products/1410440>

Classifications

ECLASS

ECLASS-9.0	27144425
ECLASS-10.0.1	27144425
ECLASS-11.0	27144425

ETIM

ETIM 8.0	EC000451
----------	----------

UNSPSC

UNSPSC 21.0	39121400
-------------	----------

Cable sleeve - CES-STPG-GY-2X9



1410440

<https://www.phoenixcontact.com/pc/products/1410440>

Environmental Product Compliance

China RoHS	Environmentally friendly use period: unlimited = EFUP-e
	No hazardous substances above threshold values

Cable sleeve - CES-STPG-GY-2X9

1410440

<https://www.phoenixcontact.com/pc/products/1410440>



Accessories

Filler plugs

Filler plugs - KDT-ST 9 - 3063989

<https://www.phoenixcontact.com/pc/products/3063989>

Filler plugs, material: PA, length: 20 mm, diameter: 9 mm



Sealing frame

Sealing frame - CES-B10-HFFS-PLBK - 0801663

<https://www.phoenixcontact.com/pc/products/0801663>

Sealing frame with locking latch, size B10, with flat gasket, for 6 small sleeves



Cable sleeve - CES-STPG-GY-2X9

1410440

<https://www.phoenixcontact.com/pc/products/1410440>



Sealing frame

Sealing frame - CES-B16-HFFS-PLBK - 0801662

<https://www.phoenixcontact.com/pc/products/0801662>



Sealing frame with locking latch, size B16, with flat gasket, for 8 small sleeves

Sealing frame

Sealing frame - CES-B24-HFFS-PLBK - 0801661

<https://www.phoenixcontact.com/pc/products/0801661>



Sealing frame with locking latch, size B24, with flat gasket, for 10 small sleeves

Cable sleeve - CES-STPG-GY-2X9

1410440

<https://www.phoenixcontact.com/pc/products/1410440>

Sealing frame

Sealing frame - CES-B10-SFFS-PLBK - 0801660

<https://www.phoenixcontact.com/pc/products/0801660>



Sealing frame with screw locking, size B10, with flat gasket, for 6 small sleeves

Sealing frame

Sealing frame - CES-B16-SFFS-PLBK - 0801659

<https://www.phoenixcontact.com/pc/products/0801659>



Sealing frame with screw locking, size B16, with flat gasket, for 8 small sleeves

Cable sleeve - CES-STPG-GY-2X9

1410440

<https://www.phoenixcontact.com/pc/products/1410440>



Sealing frame

Sealing frame - CES-B24-SFFS-PLBK - 0801658

<https://www.phoenixcontact.com/pc/products/0801658>



Sealing frame with screw locking, size B24, with flat gasket, for 10 small sleeves

Phoenix Contact 2022 © - all rights reserved

<https://www.phoenixcontact.com>

PHOENIX CONTACT GmbH & Co. KG

Flachsmarktstraße 8

D-32825 Blomberg

+49 (0) 5235-3 00

info@phoenixcontact.com