

FO converters - PSI-MOS-PROFIB/FO 850 T



2708261

<https://www.phoenixcontact.com/pc/products/2708261>

Please be informed that the data shown in this PDF document is generated from our Online Catalog. Please find the complete data in the user documentation. Our General Terms of Use for Downloads are valid.



FO converter with integrated optical diagnostics, alarm contact, for PROFIBUS up to 12 Mbps, T-coupler with two FO interfaces (BFOC), 850 nm, for PCF/fiberglass cable (multimode)

Product Description

The **PSI-MOS-PROFIB/FO...** devices convert copper-based PROFIBUS interfaces to fiber optics. The integrated optical diagnostics allow permanent monitoring of the FO paths during installation and also during operation. The floating switch contact is activated when the signal output on the fiber optic paths drops to a critical level. The **PSI-MOS-PROFIB/FO...** T T-couplers allow the interface to be converted for two **FO cables**. They can be used to create linear structures and ring structures for increased system availability.

Your advantages

- Can be combined with the PSI copper repeater in a modular way using DIN rail connectors
- Supply voltage and data signals routed through the DIN rail connectors
- Connections can be plugged in via a COMBICON screw terminal block
- Automatic data rate detection or fixed data rate setting via DIP switches
- Redundant power supply
- High-quality electrical isolation between all interfaces (PROFIBUS // fiber optic ports // power supply // DIN rail connector)
- Approved for use in zone 2
- Integrated optical diagnostics for continuous monitoring of FO paths
- Intrinsically safe fiber optic interface (Ex op is) for direct connection to devices in zone 1
- Floating switch contact for advance warning of critical FO paths
- Suitable for all data rates up to 12 Mbps
- Bit retiming for any cascading depth
- Shipbuilding approval in accordance with DNV GL

Commercial Data

Item number	2708261
Packing unit	1 pc
Minimum order quantity	1 pc
Product Key	DNC211
Catalog Page	Page 431 (C-6-2019)
GTIN	4017918973964
Weight per Piece (including packing)	265.2 g
Weight per Piece (excluding packing)	265.2 g
Customs tariff number	85176200

FO converters - PSI-MOS-PROFIB/FO 850 T



2708261

<https://www.phoenixcontact.com/pc/products/2708261>

Country of origin	DE
-------------------	----

Technical Data

Notes

Utilization restriction

EMC note	EMC: class A product, see manufacturer's declaration in the download area
----------	---------------------------------------------------------------------------

Utilization restriction

CCCex note	Use in potentially explosive areas is not permitted in China.
------------	---------------------------------------------------------------

Product properties

Product type	Media converter
MTTF	212 Years (SN 29500 standard, temperature 25°C, operating cycle 21%)
	150 Years (SN 29500 standard, temperature 40°C, operating cycle 34.25%)
	86 Years (SN 29500 standard, temperature 40°C, operating cycle 100%)
MTBF	149 Years (Telcordia standard, 25°C temperature, 21% operating cycle (5 days a week, 8 hours a day))
	24 Years (Telcordia standard, 40°C temperature, 34.25% operating cycle (5 days a week, 12 hours a day))

Electrical properties

Electrical isolation	VCC // RS-485
Maximum power dissipation for nominal condition	2.88 W
Test voltage data interface/power supply	1.5 kV _{rms} (50 Hz, 1 min.)

Supply

Supply voltage range	18 V DC ... 30 V DC (via pluggable COMBICON screw terminal block)
Nominal supply voltage	24 V DC (in acc. with UL)
Typical current consumption	120 mA (24 V DC)
Max. current consumption	130 mA
	≤ 2 A (For operation in a joining station, via the DIN rail connector)
Connection method	COMBICON plug-in screw terminal block

Output data

Switching

Output name	Relay output
Output description	Alarm output
Number of outputs	1
Maximum switching voltage	60 V DC (Resistive Load, General Load)
	30 V AC (Resistive load)
	42 V AC (peak, resistive load)

FO converters - PSI-MOS-PROFIB/FO 850 T



2708261

<https://www.phoenixcontact.com/pc/products/2708261>

Limiting continuous current	0.46 A
-----------------------------	--------

Connection data

Supply

Connection method	COMBICON plug-in screw terminal block
Stripping length	7 mm
Tightening torque	0.56 Nm ... 0.79 Nm

Interfaces

Bit distortion, input	± 35 % (permitted)
Bit distortion, output	< 6.25 %
Bit delay	< 1 bit (DIP 7 = OFF, standard operation)
	11 bit (DIP 7 = ON, redundancy operation)
Signal	PROFIBUS

Data: optical FO

No. of channels	2
Transmit capacity, minimum	-4.2 dBm (200/230 μm)
	-17.8 dBm (50/125 μm)
	-14.6 dBm (62,5/125 μm)
Transmission length incl. 3 dB system reserve	2600 m (with F-G 50/125 2.5 dB/km)
	3300 m (with F-G 62,5/125 3.0 dB/km)
	800 m (With F-K 200/230 10 dB/km with quick mounting connector)
Transmission protocol	Protocol-transparent to the RS-485 interface
Connection method	B-FOC (ST®)
Wavelength	850 nm
Minimum receiver sensitivity	-30 dBm (50/125 μm)
Maximum receiver sensitivity	-3 dBm (200/230 μm)
Transmission medium	PCF fiber
	Multi-mode fiberglass

Data: PROFIBUS acc. to IEC 61158, RS-485 2-wire, half duplex, automatic control

Serial transmission speed	≤ 12 Mbps
Connection method	D-SUB-9 female connector
Transmission length	≤ 1200 m (depending on the data rate, with shielded, twisted pair data cable)
Conductor cross section flexible max.	2.5 mm ²
Conductor cross section flexible min.	0.2 mm ²
Conductor cross section solid max.	2.5 mm ²
Conductor cross section solid min.	0.2 mm ²
Max. AWG conductor cross section, flexible	14
Min. AWG conductor cross section, flexible	24
Single-wire/terminal point, solid AWG max.	14
Single-wire/terminal point, solid AWG min.	24

2708261

<https://www.phoenixcontact.com/pc/products/2708261>

Transmission medium	Copper
File format/coding	UART (11 Bit, NRZ)
Data direction switching	Automatic control
Output nominal voltage	5 V ±0.25 (50 mA)

Dimensions

Width	35 mm
Height	99 mm
Depth	106 mm

Material specifications

Material	PA 6.6-FR (Housing)
----------	---------------------

Cable / line

FO cable

Fiber types	50/125 µm
	62.5/125 µm
	Fiberglass

Environmental and real-life conditions

Ambient conditions

Degree of protection	IP20
Ambient temperature (operation)	-20 °C ... 60 °C
Ambient temperature (storage/transport)	-40 °C ... 85 °C
Altitude	≤ 5000 m (For restrictions, see the manufacturer's declaration for altitude operation)
	≤ 2000 m (Hazardous locations)
Permissible humidity (operation)	30 % ... 95 % (non-condensing)

Approval data

CE

Certificate	CE-compliant
-------------	--------------

EAC

Identification	EAC
----------------	-----

ATEX

Identification	<input type="checkbox"/> II 3 G Ex nA nC IIC T4 Gc X
Note	Please follow the special installation instructions in the documentation!

ATEX, FO interface

Identification	<input type="checkbox"/> II (2) G [Ex op is Gb] IIC
	<input type="checkbox"/> II (2) D [Ex op is Db] IIIC
Certificate	PTB 06 ATEX 2042 U

2708261

<https://www.phoenixcontact.com/pc/products/2708261>

Note	Please follow the special installation instructions in the documentation!
------	---------------------------------------------------------------------------

UL, USA / Canada

Identification	Class I, Zone 2, AEx nc IIC T5
	Class I, Zone 2, Ex nC nL IIC T5 X
	Class I, Div. 2, Groups A, B, C, D

PROFIBUS interoperability

Note	Tested by independent PNO test laboratory (PN059-485-01)
------	----------------------------------------------------------

ABB certification

Identification	Industrial ^{IT} enabled
Note	This certification is a trademark of ABB.

Corrosive gas test

Identification	ISA-S71.04-1985 G3 Harsh Group A
----------------	----------------------------------

Shipbuilding

Identification	DNV GL
----------------	--------

DNV GL data

Temperature	B
Humidity	A
Vibration	A
EMC	B
Enclosure	Required protection according to the Rules shall be provided upon installation on board

EMC data

Electromagnetic compatibility	Conformance with EMC Directive 2014/30/EU
Noise emission	EN 55011
Noise immunity	EN 61000-6-2:2005

Electrostatic discharge

Standards/regulations	EN 61000-4-2
-----------------------	--------------

Electrostatic discharge

Contact discharge	± 6 kV
Discharge in air	± 8 kV
Comments	Criterion B

Electromagnetic HF field

Standards/regulations	EN 61000-4-3
-----------------------	--------------

Electromagnetic HF field

Field intensity	10 V/m
Comments	Criterion A

Fast transients (burst)

FO converters - PSI-MOS-PROFIB/FO 850 T



2708261

<https://www.phoenixcontact.com/pc/products/2708261>

Standards/regulations	EN 61000-4-4
-----------------------	--------------

Fast transients (burst)

Input	± 2 kV
Signal	± 2 kV
Comments	Criterion B

Surge current load (surge)

Standards/regulations	EN 61000-4-5
-----------------------	--------------

Surge current load (surge)

Input	± 0.5 kV
Signal	± 1 kV
Comments	Criterion B

Conducted interference

Standards/regulations	EN 61000-4-6
-----------------------	--------------

Conducted interference

Comments	Criterion A
Voltage	10 V

Emitted interference

Standards/regulations	EN 55011
Comments	Class A, industrial applications
Criterion A	Normal operating behavior within the specified limits.
Criterion B	Temporary impairment to operational behavior that is corrected by the device itself.

Standards and regulations

Free from substances that could impair the application of coating	in accordance with VW-AUDI-Seat central standard P-VW 3.10.7 57 65 0
-------------------------------------------------------------------	----------------------------------------------------------------------

Air clearances and creepage distances

Standards/regulations	DIN EN 60664-1
	VDE 0110-1
	DIN EN 50178
	EN 60950

Mounting

Mounting type	DIN rail mounting
---------------	-------------------

2708261

<https://www.phoenixcontact.com/pc/products/2708261>

Drawings

Application drawing

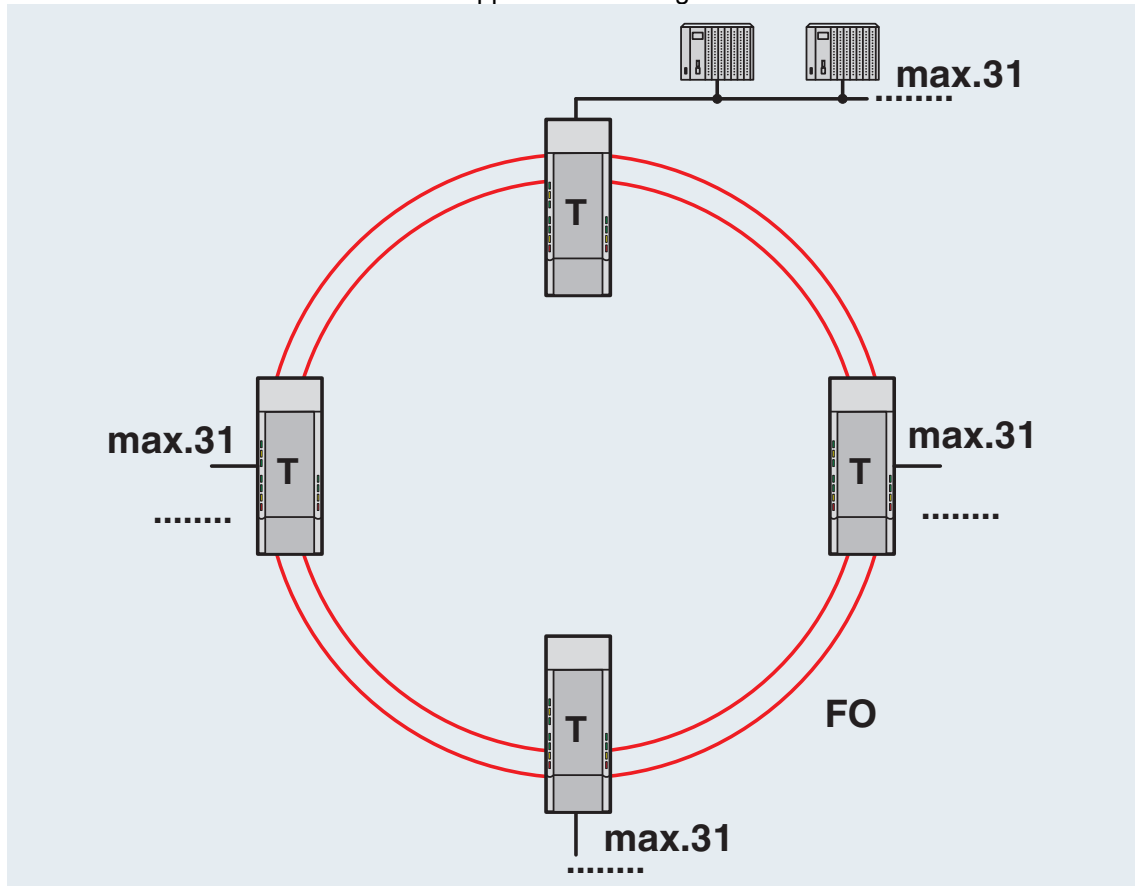

Redundant FO ring

FO converters - PSI-MOS-PROFIB/FO 850 T



2708261

<https://www.phoenixcontact.com/pc/products/2708261>

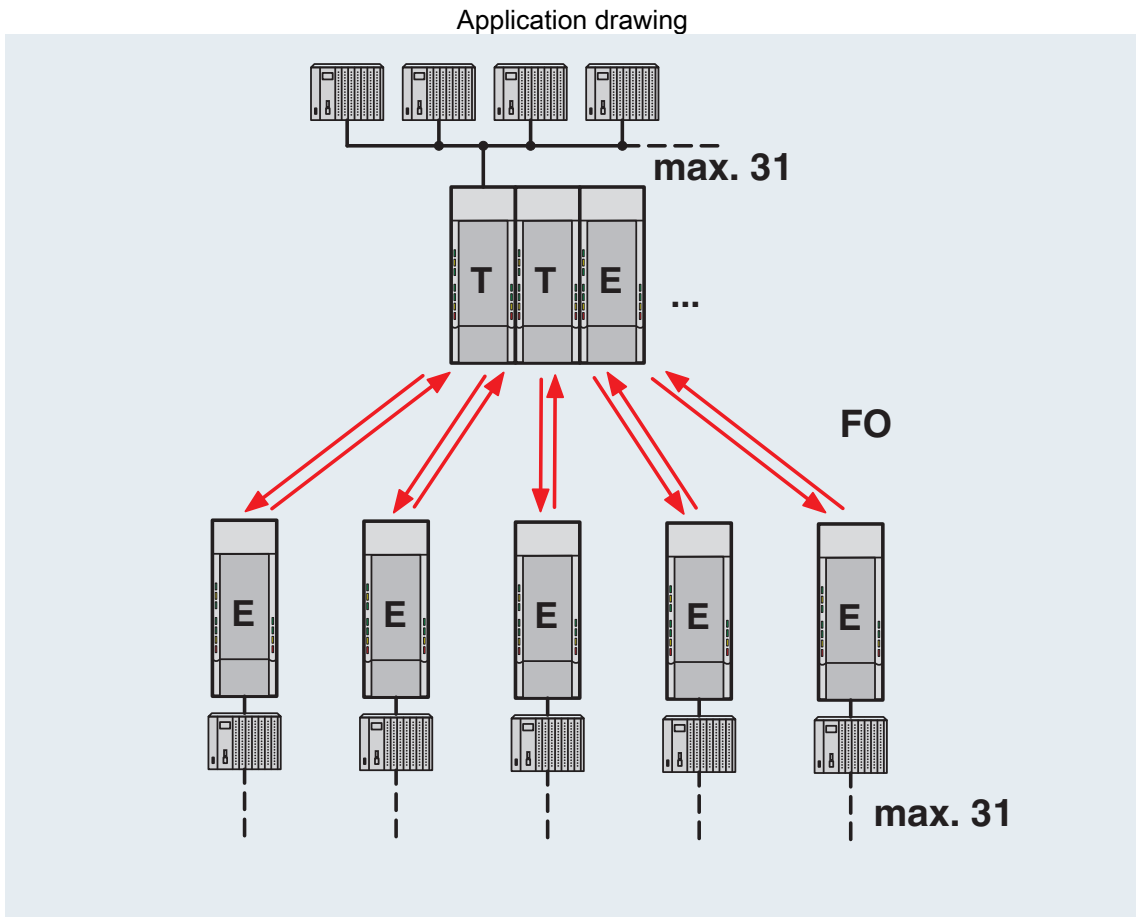

Star structure

Application drawing

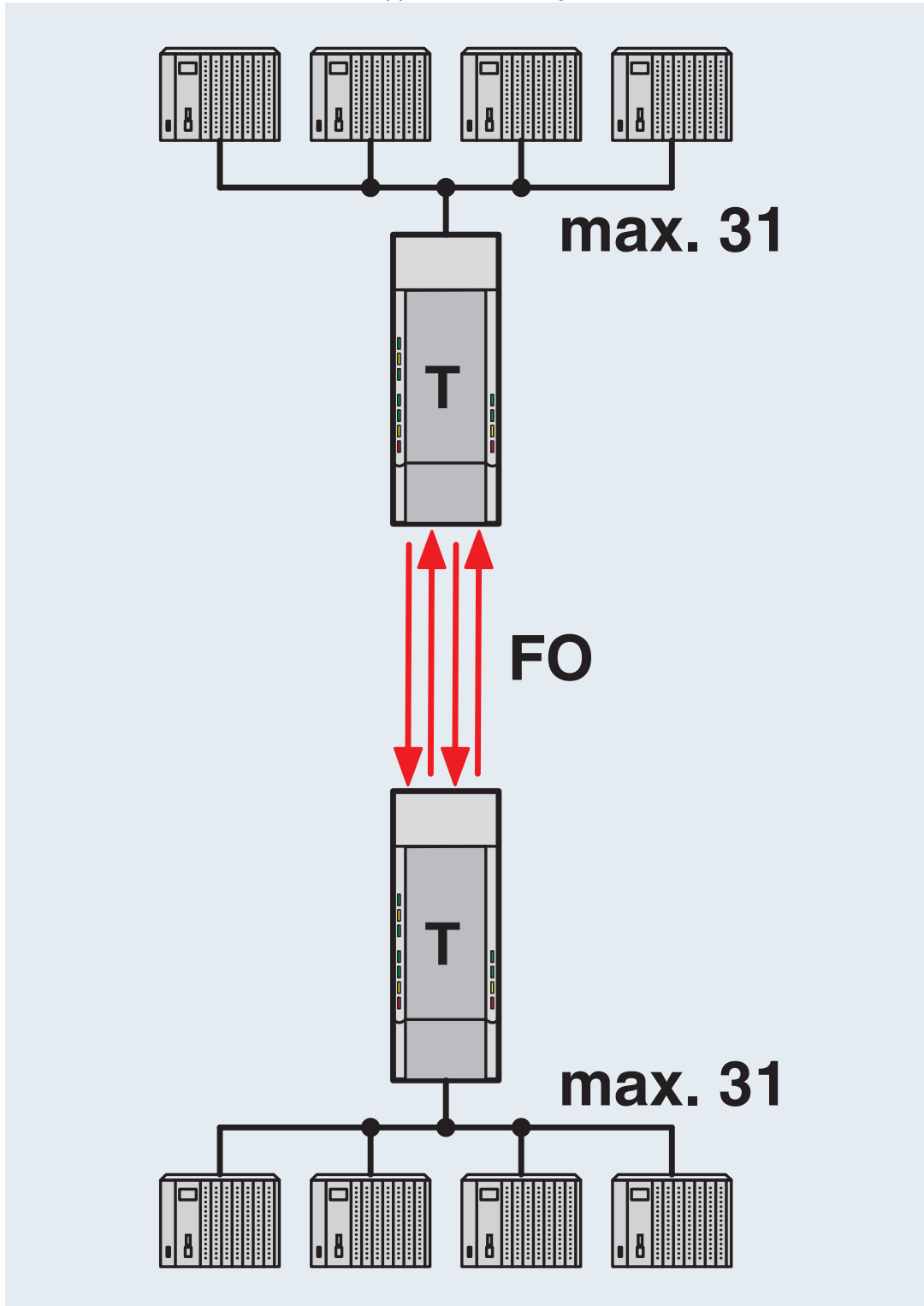

Redundant point-to-point connection

Application drawing

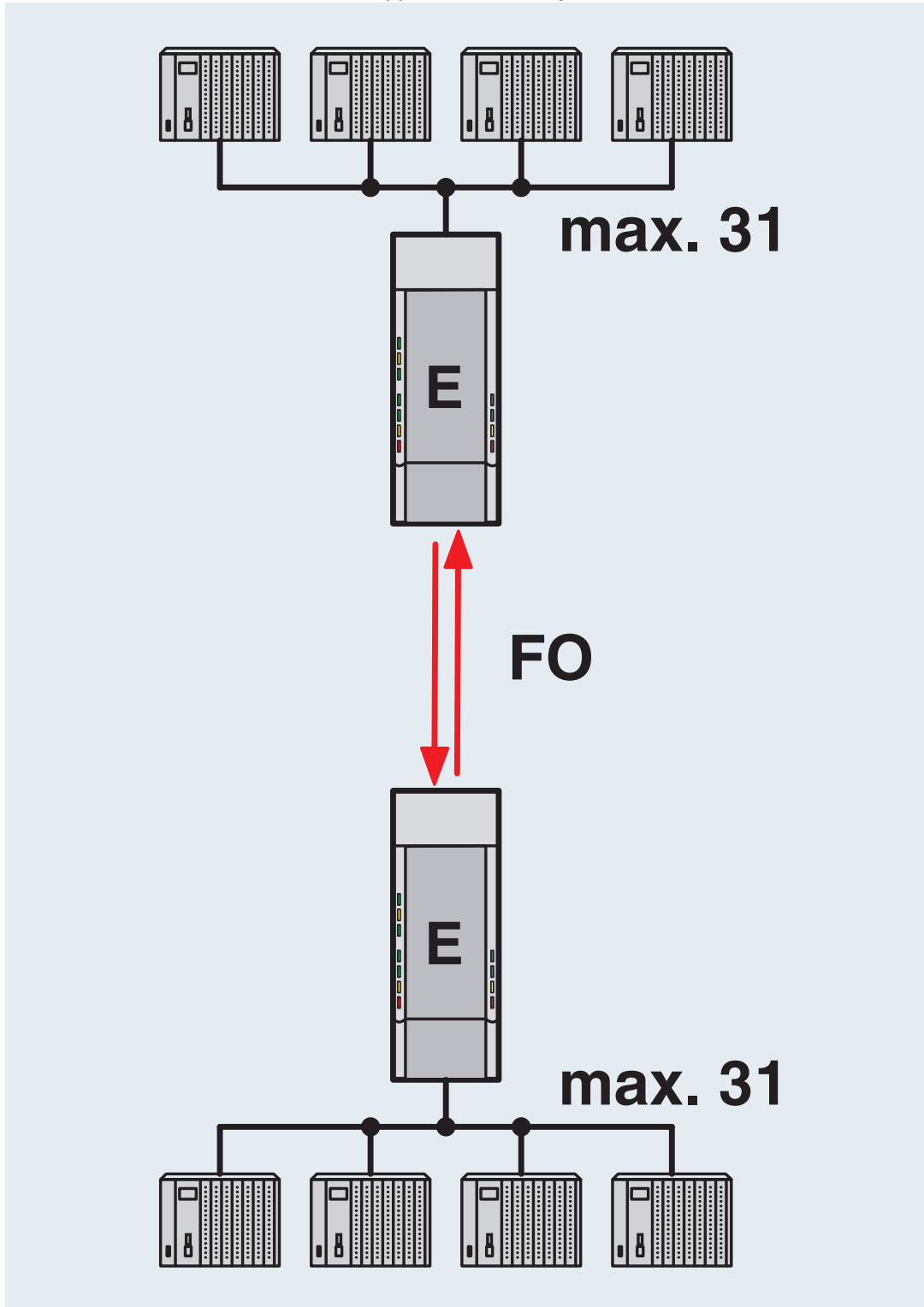

Point-to-point connection

2708261

<https://www.phoenixcontact.com/pc/products/2708261>

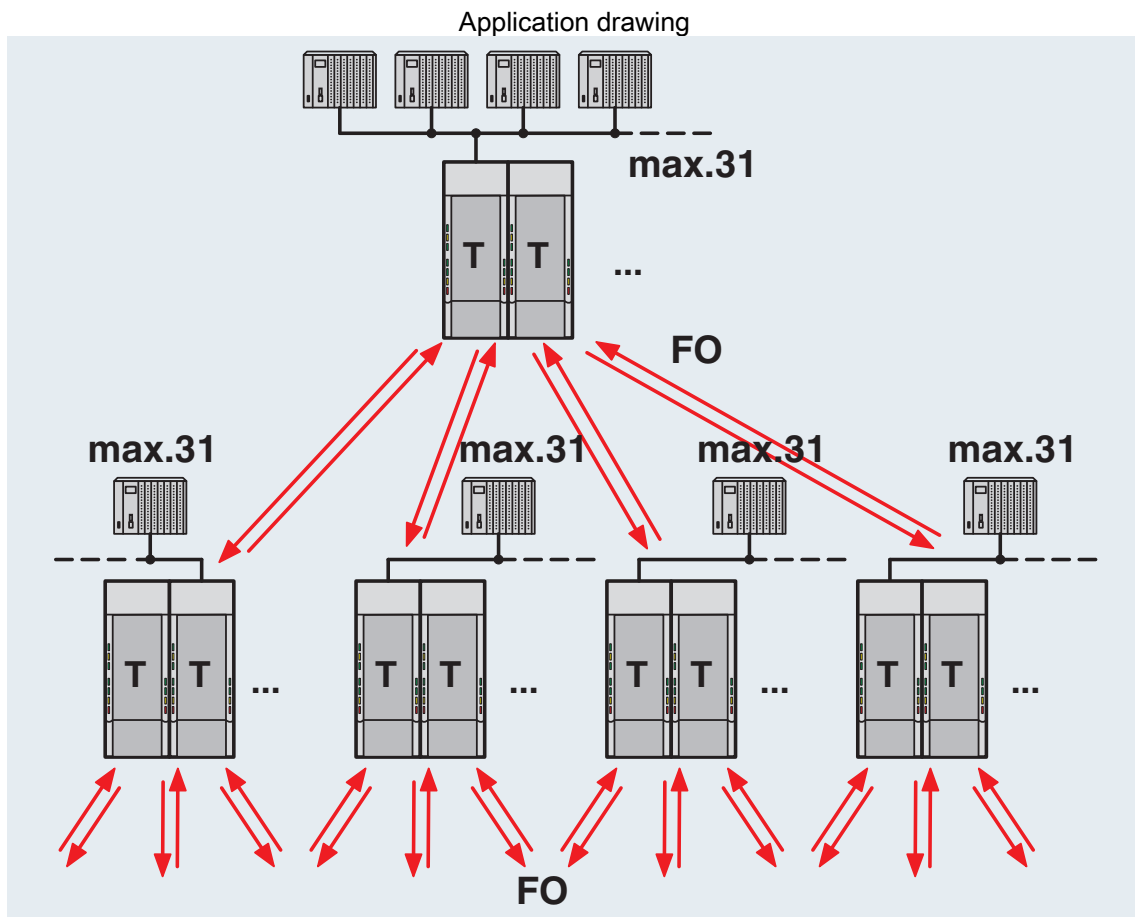

Tree structure

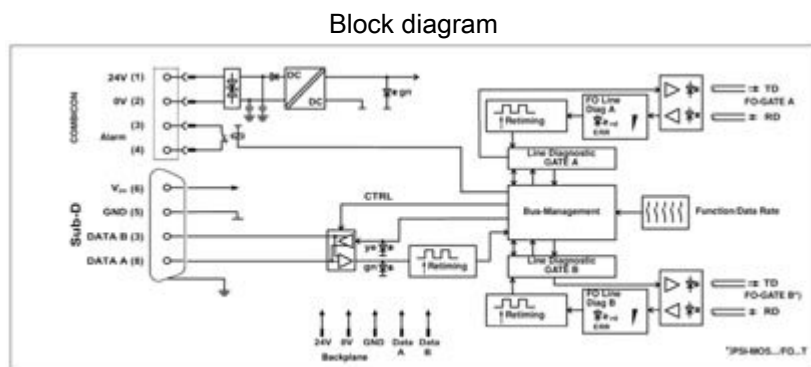

*) only with PSI-MOS.../FO...T

FO converters - PSI-MOS-PROFIB/FO 850 T

2708261

<https://www.phoenixcontact.com/pc/products/2708261>

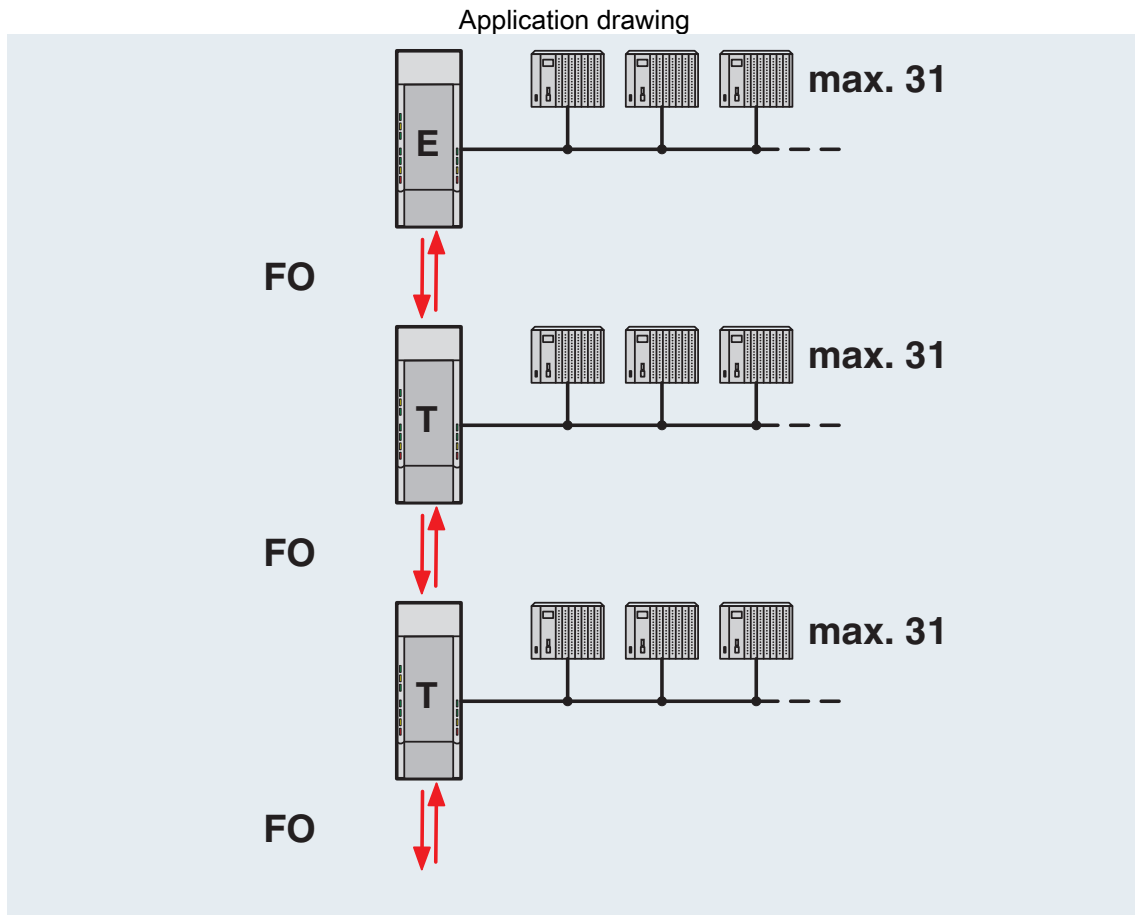

Line structure

2708261

<https://www.phoenixcontact.com/pc/products/2708261>

Approvals



cUL Recognized
Approval ID: FILE E 238705



UL Recognized
Approval ID: FILE E 238705



EAC
Approval ID: EAC-Zulassung



DNV GL
Approval ID: TAA00001KR

Nominal Voltage U_N	Nominal Current I_N	Cross Section AWG	Cross Section mm^2
		-	-



EAC
Approval ID: RU *-DE.A*30.B.01735



KC
Approval ID: MSIP-REI-PCK-2708261



ATEX
Approval ID: PTB 06 ATEX 2042U

Nominal Voltage U_N	Nominal Current I_N	Cross Section AWG	Cross Section mm^2
		-	-



ATEX
Approval ID: PxCIF06ATEX2708261X



cUL Listed
Approval ID: FILE E 199827



UL Listed
Approval ID: FILE E 199827

cULus Recognized

FO converters - PSI-MOS-PROFIB/FO 850 T

2708261

<https://www.phoenixcontact.com/pc/products/2708261>



cULus Listed

FO converters - PSI-MOS-PROFIB/FO 850 T



2708261

<https://www.phoenixcontact.com/pc/products/2708261>

Classifications

ECLASS

ECLASS-9.0	19170114
ECLASS-10.0.1	19170132
ECLASS-11.0	19170411

ETIM

ETIM 8.0	EC001467
----------	----------

UNSPSC

UNSPSC 21.0	43201500
-------------	----------

FO converters - PSI-MOS-PROFIB/FO 850 T



2708261

<https://www.phoenixcontact.com/pc/products/2708261>

Environmental Product Compliance

REACH SVHC	Lead 7439-92-1
China RoHS	Environmentally Friendly Use Period = 50 years
	For information on hazardous substances, refer to the manufacturer's declaration available under "Downloads"

FO converters - PSI-MOS-PROFIB/FO 850 T



2708261

<https://www.phoenixcontact.com/pc/products/2708261>

Accessories

FO connectors

FO connectors - PSM-SET-B-FOC/4-HCS - 2708481

<https://www.phoenixcontact.com/pc/products/2708481>

B-FOC (ST) connector set for PCF fiber, for self assembly consisting of 4 quick mounting connectors with bend protection sleeve



FO cable

FO cable - PSM-LWL-HCS-RUGGED-200/230 - 2799885

<https://www.phoenixcontact.com/pc/products/2799885>

PCF cable, duplex 200 μm /230 μm , by the meter without male connector, for installation in stationary systems and machines



FO converters - PSI-MOS-PROFIB/FO 850 T

2708261

<https://www.phoenixcontact.com/pc/products/2708261>

FO cable

FO cable - PSM-LWL-HCSO-200/230 - 2799445

<https://www.phoenixcontact.com/pc/products/2799445>



PCF cable, duplex 200/230 μm , by the meter, without connector, for outdoor installation

FO cable

FO cable - PSM-LWL-GDM-RUGGED- 50/125 - 2799322

<https://www.phoenixcontact.com/pc/products/2799322>



Fiber glass cable, duplex 50 μm /125 μm , by the meter, without male connector, for installation in stationary systems and machines

FO converters - PSI-MOS-PROFIB/FO 850 T

2708261

<https://www.phoenixcontact.com/pc/products/2708261>

FO cable

FO cable - PSM-LWL-GDO- 50/125 - 2799432

<https://www.phoenixcontact.com/pc/products/2799432>



Fiberglass cable, duplex 50/125 μm , by the meter, without connector, for outdoor installation

Power supply unit

Power supply unit - QUINT4-SYS-PS/1AC/24DC/2.5/SC - 2904614

<https://www.phoenixcontact.com/pc/products/2904614>



Primary-switched power supply unit, QUINT POWER, Screw connection, DIN rail mounting, input: 1-phase, output: 24 V DC / 2.5 A

FO converters - PSI-MOS-PROFIB/FO 850 T

2708261

<https://www.phoenixcontact.com/pc/products/2708261>

DIN rail bus connectors

DIN rail bus connectors - ME 17,5 TBUS 1,5/ 5-ST-3,81 GN - 2709561

<https://www.phoenixcontact.com/pc/products/2709561>

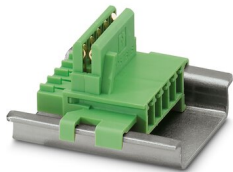

DIN rail connector for DIN rail mounting. Universal for TBUS housing. Gold-plated contacts, 5-pos.

DIN rail bus connectors

DIN rail bus connectors - ME 17,5 TBUS 1,5/PP000-3,81 BK - 2890014

<https://www.phoenixcontact.com/pc/products/2890014>

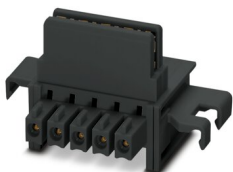

DIN rail connector for DIN rail mounting. Universal for TBUS housing. Gold-plated contacts, 2-pos.

2708261

<https://www.phoenixcontact.com/pc/products/2708261>

DIN rail bus connectors

DIN rail bus connectors - ME 17,5 TBUS 1,5/ 5-ST-3,81 KMGY - 2713645

<https://www.phoenixcontact.com/pc/products/2713645>

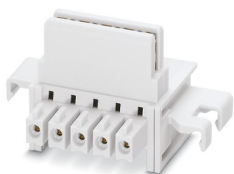

DIN rail connector, color: light grey, nominal current: 8 A (parallel contacts), rated voltage (III/2): 125 V, number of positions: 5, pitch: 3.81 mm, mounting: DIN rail mounting, locking: without, mounting: without, type of packaging: packed in cardboard, Item with gold-plated contacts, bus connectors for connecting with electronics housings, 5 parallel contacts

Assembly tool

Assembly tool - PSM-HCS-KONFTOOL/B-FOC - 2708465

<https://www.phoenixcontact.com/pc/products/2708465>



HCS assembly kit for B-FOC(ST) quick mounting connectors, including stripping blade, stripping pliers, aramide yarn scissors, fiber stripper, microscope, fiber cleaving tool for standard HCS and HCS GI fibers, four B-FOC(ST) connectors for standard HCS fiber, and documentation

FO converters - PSI-MOS-PROFIB/FO 850 T



2708261

<https://www.phoenixcontact.com/pc/products/2708261>

Measuring instrument

Measuring instrument - PSM-FO-POWERMETER - 2799539

<https://www.phoenixcontact.com/pc/products/2799539>



Fiber optic measuring case, consisting of an optical power meter, F-SMA, B-FOC adapters, reference fibers and operating instructions

Fiber optic coupling

Fiber optic coupling - PSM-SET-BFOC-LINK/2 - 2799429

<https://www.phoenixcontact.com/pc/products/2799429>

Coupling; set consisting of 2 couplings for connecting B-FOC plugs



FO converters - PSI-MOS-PROFIB/FO 850 T

2708261

<https://www.phoenixcontact.com/pc/products/2708261>

D-SUB bus connector

D-SUB bus connector - SUBCON-PLUS-PROFIB/SC2 - 2708232

<https://www.phoenixcontact.com/pc/products/2708232>

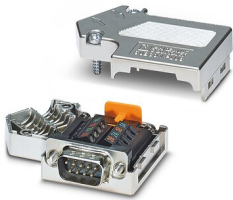

D-SUB connector, 9-pos., male connector, 35° cable entry, bus system: PROFIBUS DP up to 12 Mbps, termination resistor can be switched on via slide switch, pin assignment: 3, 5, 6, 8; screw connection terminal blocks

D-SUB bus connector

D-SUB bus connector - SUBCON-PLUS-PROFIB/PG/SC2 - 2708245

<https://www.phoenixcontact.com/pc/products/2708245>



D-SUB connector, 9-pos., male connector, 35° cable entry, bus system: PROFIBUS DP up to 12 Mbps with PG D-SUB socket for connecting a programming device, termination resistor can be switched on via slide switch, pin assignment: 3, 5, 6, 8; screw connection terminal blocks

FO converters - PSI-MOS-PROFIB/FO 850 T

2708261

<https://www.phoenixcontact.com/pc/products/2708261>

D-SUB bus connector

D-SUB bus connector - SUBCON-PLUS-PROFIB/AX/SC - 2744380

<https://www.phoenixcontact.com/pc/products/2744380>



D-SUB connector, 9-pos., male connector, axial version with two cable entries, bus system: PROFIBUS DP up to 12 Mbps, termination resistor can be switched on via slide switch, pin assignment: 3, 5, 6, 8; screw connection terminal blocks

Screwdriver

Screwdriver - SZS 0,4X2,5 VDE - 1205037

<https://www.phoenixcontact.com/pc/products/1205037>



Screwdriver, slot-headed, VDE insulated, size: 0.4 x 2.5 x 80 mm, 2-component grip, with non-slip grip

FO converters - PSI-MOS-PROFIB/FO 850 T

2708261

<https://www.phoenixcontact.com/pc/products/2708261>

Stripping tool

Stripping tool - PSM-STRIP-FC/PROFIB - 2744623

<https://www.phoenixcontact.com/pc/products/2744623>

Quick stripping tool for PROFIBUS cable, type Fast Connect



Connection distributor

Connection distributor - PSM PTK - 2760623

<https://www.phoenixcontact.com/pc/products/2760623>

Passive RS-485 T-distributor, fitted with one 9-pin D-SUB pin strip and two 9-pin D-SUB socket strips

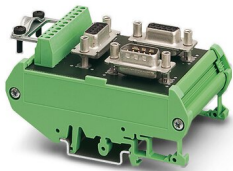

FO converters - PSI-MOS-PROFIB/FO 850 T



2708261

<https://www.phoenixcontact.com/pc/products/2708261>

Connection distributor

Connection distributor - PSM PTK-4 - 2799364

<https://www.phoenixcontact.com/pc/products/2799364>

Passive RS-485 T-distributor, fitted with one 9-pin D-SUB pin strip and five 9-pin D-SUB socket strips



Repeater

Repeater - PSI-REP-PROFIBUS/12MB - 2708863

<https://www.phoenixcontact.com/pc/products/2708863>

Modular repeater for electrical isolation and range increase for PROFIBUS up to 12 Mbps, 4-way isolation, rail-mountable, supply 24 V DC



FO converters - PSI-MOS-PROFIB/FO 850 T

2708261

<https://www.phoenixcontact.com/pc/products/2708261>

Repeater

Repeater - PSM-ME-RS485/RS485-P - 2744429

<https://www.phoenixcontact.com/pc/products/2744429>



Repeater, for potential separation and range increase in RS-485 2-wire bus systems, 3-way isolation, rail-mountable

Bus system cable

Bus system cable - PSM-CABLE-PROFIB/FC - 2744652

<https://www.phoenixcontact.com/pc/products/2744652>



By the meter, Bus system cable, PROFIBUS (12 Mbps), shielded, PVC FR VI/PVC, violet, 2-wire (1X2XAWG22/1), color single wire: Red, green, cable length: Free entry (1.0 ... 1000.0 m)

FO converters - PSI-MOS-PROFIB/FO 850 T

2708261

<https://www.phoenixcontact.com/pc/products/2708261>

FO patch cable

FO patch cable - FOC-ST:PA-SC:PA-OM2:D01/1 - 1115574

<https://www.phoenixcontact.com/pc/products/1115574>

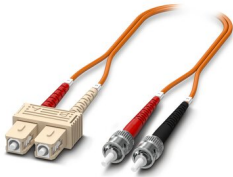

Multi-mode OM2 duplex jumper, ST-SC, UPC polishing, length 1 m

FO patch cable

FO patch cable - FOC-ST:PA-SC:PA-OM2:D01/2 - 1115573

<https://www.phoenixcontact.com/pc/products/1115573>

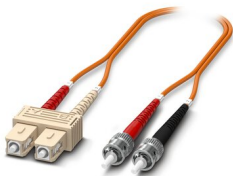

Multi-mode OM2 duplex jumper, ST-SC, UPC polishing, length 2 m

FO converters - PSI-MOS-PROFIB/FO 850 T

2708261

<https://www.phoenixcontact.com/pc/products/2708261>

FO patch cable

FO patch cable - FOC-ST:PA-ST:PA-OM2:D01/1 - 1115560

<https://www.phoenixcontact.com/pc/products/1115560>

Multi-mode OM2 duplex jumper, ST-ST, UPC polishing, length 1 m



FO patch cable

FO patch cable - FOC-ST:PA-ST:PA-OM2:D01/2 - 1115557

<https://www.phoenixcontact.com/pc/products/1115557>

Multi-mode OM2 duplex jumper, ST-ST, UPC polishing, length 2 m



FO converters - PSI-MOS-PROFIB/FO 850 T

2708261

<https://www.phoenixcontact.com/pc/products/2708261>

Fiber optic cable

Fiber optic cable - FOC-LC:PA-ST:PA-OM2:D01/1 - 1115588

<https://www.phoenixcontact.com/pc/products/1115588>

Multi-mode OM2 duplex jumper, LC-ST, UPC polishing, length 1 m

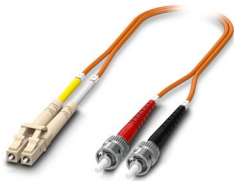

Fiber optic cable

Fiber optic cable - FOC-LC:PA-ST:PA-OM2:D01/2 - 1115587

<https://www.phoenixcontact.com/pc/products/1115587>

Multi-mode OM2 duplex jumper, LC-ST, UPC polishing, length 2 m

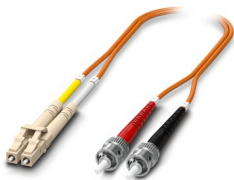

FO converters - PSI-MOS-PROFIB/FO 850 T

2708261

<https://www.phoenixcontact.com/pc/products/2708261>

FO patch cable

FO patch cable - FOC-LC:PA-ST:PA-OM1:D01/1 - 1146499

<https://www.phoenixcontact.com/pc/products/1146499>

Multi-mode OM1 duplex jumper, LC-ST, UPC polishing, length 1 m

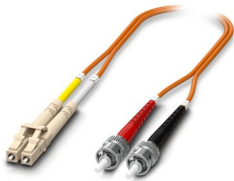

FO patch cable

FO patch cable - FOC-LC:PA-ST:PA-OM1:D01/2 - 1146508

<https://www.phoenixcontact.com/pc/products/1146508>

Multi-mode OM1 duplex jumper, LC-ST, UPC polishing, length 2 m

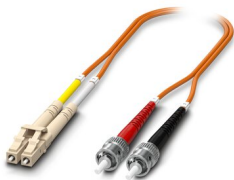

FO converters - PSI-MOS-PROFIB/FO 850 T

2708261

<https://www.phoenixcontact.com/pc/products/2708261>

FO patch cable

FO patch cable - FOC-ST:PA-ST:PA-OM1:D01/1 - 1146501

<https://www.phoenixcontact.com/pc/products/1146501>

Multi-mode OM1 duplex jumper, ST-ST, UPC polishing, length 1 m



FO patch cable

FO patch cable - FOC-ST:PA-ST:PA-OM1:D01/2 - 1146509

<https://www.phoenixcontact.com/pc/products/1146509>

Multi-mode OM1 duplex jumper, ST-ST, UPC polishing, length 2 m



FO converters - PSI-MOS-PROFIB/FO 850 T

2708261

<https://www.phoenixcontact.com/pc/products/2708261>

Termination resistor

Termination resistor - PSI-TERMINATOR-PB-TBUS - 2702636

<https://www.phoenixcontact.com/pc/products/2702636>



Active termination resistor for PROFIBUS and RS-485 bus systems, redundant power supply, routing of the supply voltage via DIN rail connector, electrical isolation, switchable termination, integrated programming interface

D-SUB bus connector

D-SUB bus connector - SUBCON-PLUS-PROFIB/AX/M12 - 2902321

<https://www.phoenixcontact.com/pc/products/2902321>



D-SUB plug, 9-pos., pin, assignment: 3, 5, 6, 8; two M12 cable glands (B-coded) under 180° (axial). Bus system: PROFIBUS DP up to 12 Mbps. Termination resistor via separate M12 terminator.

FO converters - PSI-MOS-PROFIB/FO 850 T

2708261

<https://www.phoenixcontact.com/pc/products/2708261>

D-SUB bus connector

D-SUB bus connector - SUBCON-PLUS-PROFIB/90X/M12 - 2902729

<https://www.phoenixcontact.com/pc/products/2902729>

D-SUB plug, 9-pos., pin, assignment: 3, 5, 6, 8; two 90° cable entries M12 (B-coded). Bus system: PROFIBUS DP up to 12 Mbps. Termination resistor via separate M12 terminator. Long version; S7-compatible.

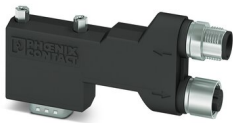

D-SUB bus connector

D-SUB bus connector - SUBCON-PLUS-PROFIB/90/M12 - 2902318

<https://www.phoenixcontact.com/pc/products/2902318>

D-SUB plug, 9-pos., pin, assignment: 3, 5, 6, 8; two 90° M12 cable glands (B-coded). Bus system: PROFIBUS DP up to 12 Mbps. Termination resistor via separate M12 terminator.



FO converters - PSI-MOS-PROFIB/FO 850 T



2708261

<https://www.phoenixcontact.com/pc/products/2708261>

D-SUB bus connector

D-SUB bus connector - SUBCON-PLUS-PROFIB/35/M12 - 2902320

<https://www.phoenixcontact.com/pc/products/2902320>



D-SUB plug, 9-pos., pin, assignment: 3, 5, 6, 8; two 35° cable entries M12 (B-coded). Bus system: PROFIBUS DP up to 12 Mbps. Termination resistor via separate M12 terminator.

FO patch cable

FO patch cable - FOC-HCS-RUGGED-1014/IP20/... - 2901555

<https://www.phoenixcontact.com/pc/products/2901555>



Robust PCF installation cable for assembly (IP20 heads only) for installation in stationary systems and machines, aramid strain relief elements, with individual elements made from FRNC material, halogen-free, ozone and UV resistant, with a polyurethane (PUR) outer sheath

FO converters - PSI-MOS-PROFIB/FO 850 T

2708261

<https://www.phoenixcontact.com/pc/products/2708261>

FO patch cable

FO patch cable - FOC-HCS-RUGGED-1014/... - 1402191

<https://www.phoenixcontact.com/pc/products/1402191>

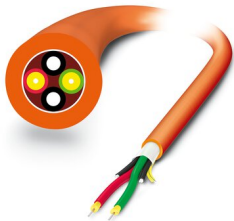

rugged PCF installation cable for inner areas with highly tear-proof aramid strain-relief elements. Individual elements made from highly flexible FRNC material. The cable is halogen-free, ozone and UV resistant and has a rugged polyurethane (PUR) outer sheath.

FO patch cable

FO patch cable - FOC-HCSO-1015/IP20/... - 2901557

<https://www.phoenixcontact.com/pc/products/2901557>



Highly rugged PCF round cable (IP20 heads only) for assembly and for outdoor installation with integrated moisture barrier as well as rodent-proof scrim. Individual elements made from highly flexible FRNC material. The wire is ozone and UV resistant with a very rugged polyethylene outer sheath.

FO converters - PSI-MOS-PROFIB/FO 850 T



2708261

<https://www.phoenixcontact.com/pc/products/2708261>

FO patch cable

FO patch cable - FOC-GDM-RUGGED-1016/IP20/... - 2901558

<https://www.phoenixcontact.com/pc/products/2901558>

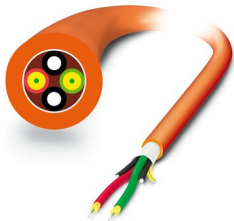

Robust GOF installation cable for assembly (IP20 heads only) for installation in stationary systems and machines, aramid strain-relief elements, with individual elements made from FRNC material, halogen-free, ozone and UV resistant, with a polyurethane (PUR) outer sheath

FO patch cable

FO patch cable - FOC-GDO-1017/IP20/... - 2901559

<https://www.phoenixcontact.com/pc/products/2901559>



Highly rugged GOF round cable (IP20 heads only) for assembly and for outdoor installation with integrated moisture barrier as well as rodent-proof scrim. Individual elements made from highly flexible FRNC material. The wire is ozone and UV resistant with a very rugged polyethylene outer sheath.

Phoenix Contact 2022 © - all rights reserved
<https://www.phoenixcontact.com>

PHOENIX CONTACT GmbH & Co. KG
Flachsmarktstraße 8
D-32825 Blomberg
+49 (0) 5235-3 00
info@phoenixcontact.com