

FO converters - PSI-MOS-RS485W2/FO 660 E



2708313

<https://www.phoenixcontact.com/pc/products/2708313>

Please be informed that the data shown in this PDF document is generated from our Online Catalog. Please find the complete data in the user documentation. Our General Terms of Use for Downloads are valid.



FO converter with integrated optical diagnostics, alarm contact, for RS-485 2-wire bus systems (SUCONET K, Modbus ...) up to 500 kbps, NRZ coding, terminal device with one FO interface (FSMA), 660 nm, for polymer/PCF fiber cable

Product Description

The **PSI-MOS-RS485W2/FO...** FO converters convert the electrical data signal into an optical one by protocol transparent means. The integrated optical diagnostics allow permanent monitoring of the FO paths during installation and also during operation. The floating switch contact is activated when the signal output on the fiber optic paths drops to a critical level. The **PSI-MOS-RS485W2/FO... E** termination devices convert an RS-485 interface to a fiber optic cable. They are ideal for point-to-point connections.

Your advantages

- Can be combined with the PSI copper repeater in a modular way using DIN rail connectors
- Supply voltage and data signals routed through the DIN rail connectors
- Connections can be plugged in via a COMBICON screw terminal block
- Automatic data rate detection or fixed data rate setting via DIP switches
- High-quality electrical isolation between all interfaces (RS-485 // fiber optic ports // power supply // DIN rail connector)
- Redundant power supply possible by means of optional system power supply unit
- Approved for use in zone 2
- Intrinsically safe fiber optic interface (Ex op is) for direct connection to devices in zone 1
- Integrated optical diagnostics for continuous monitoring of FO paths
- Floating switch contact for advance warning of critical FO paths
- Suitable for data rates up to 500 kbps
- Bit retiming for any cascading depth
- Shipbuilding approval in accordance with DNV GL

Commercial Data

Item number	2708313
Packing unit	1 pc
Minimum order quantity	1 pc
Product Key	DNC212
Catalog Page	Page 435 (C-6-2019)
GTIN	4017918974015
Weight per Piece (including packing)	232.4 g
Weight per Piece (excluding packing)	186.98 g
Customs tariff number	85176200

FO converters - PSI-MOS-RS485W2/FO 660 E



2708313

<https://www.phoenixcontact.com/pc/products/2708313>

Country of origin	DE
-------------------	----

Technical Data

Notes

Utilization restriction

EMC note	EMC: class A product, see manufacturer's declaration in the download area
----------	---

Utilization restriction

CCCex note	Use in potentially explosive areas is not permitted in China.
------------	---

Product properties

Product type	Media converter
MTTF	967 Years (SN 29500 standard, temperature 25°C, operating cycle 21%)
	428 Years (SN 29500 standard, temperature 40°C, operating cycle 34.25%)
	176 Years (SN 29500 standard, temperature 40°C, operating cycle 100%)
MTBF	358 Years (Telcordia standard, 25°C temperature, 21% operating cycle (5 days a week, 8 hours a day))
	73 Years (Telcordia standard, 40°C temperature, 34.25% operating cycle (5 days a week, 12 hours a day))

Electrical properties

Electrical isolation	VCC // RS-485
Maximum power dissipation for nominal condition	2.4 W
Test voltage data interface/power supply	1.5 kV _{rms} (50 Hz, 1 min.)

Supply

Supply voltage range	18 V DC ... 30 V DC (via pluggable COMBICON screw terminal block)
Nominal supply voltage	24 V DC (in acc. with UL)
Typical current consumption	100 mA (24 V DC)
Max. current consumption	130 mA
	≤ 2 A (For operation in a joining station, via the DIN rail connector)
Connection method	COMBICON plug-in screw terminal block

Output data

Switching

Output name	Relay output
Output description	Alarm output
Number of outputs	1
Maximum switching voltage	60 V DC (Resistive Load, General Load)
	30 V AC (Resistive load)
	42 V AC (peak, resistive load)

Limiting continuous current	0.46 A
-----------------------------	--------

Connection data

Supply

Connection method	COMBICON plug-in screw terminal block
Stripping length	7 mm
Tightening torque	0.56 Nm ... 0.79 Nm

Interfaces

Bit distortion, input	± 35 % (permitted)
Bit distortion, output	< 6.25 %
Bit delay	≤ 1 bit
Signal	Modbus
	S-BUS
	Suconet K
	J-BUS
	DATA HIGHWAY

Data: optical FO

No. of channels	1
Transmit capacity, minimum	-4.6 dBm (980/1000 μm)
	-16 dBm (200/230 μm)
Transmission length incl. 3 dB system reserve	100 m (With F-P 980/1000 230 dB/km with quick mounting connector)
	800 m (With F-K 200/230 10 dB/km with quick mounting connector)
Transmission protocol	Protocol-transparent to the RS-485 interface
Connection method	F-SMA
Wavelength	660 nm
Minimum receiver sensitivity	-30.2 dBm
Maximum receiver sensitivity	-3 dBm (980/1000 μm)
Transmission medium	Polymer fiber
	PCF fiber

Data: RS-485 interface, 2-wire

Serial transmission speed	4.8/ 9.6/ 19.2/ 38.4/ 57.6/ 75/ 93.75/ 115.2/ 136/ 187.5/ 375/ 500 kbps
Connection method	Pluggable screw connection
Transmission length	≤ 1200 m (depending on the data rate, with shielded, twisted data cable)
Termination resistor	390 Ω (Can be connected)
	220 Ω
	390 Ω
Conductor cross section flexible max.	2.5 mm ²
Conductor cross section flexible min.	0.2 mm ²
Conductor cross section solid max.	2.5 mm ²

FO converters - PSI-MOS-RS485W2/FO 660 E



2708313

<https://www.phoenixcontact.com/pc/products/2708313>

Conductor cross section solid min.	0.2 mm ²
Max. AWG conductor cross section, flexible	14
Min. AWG conductor cross section, flexible	24
Single-wire/terminal point, solid AWG max.	14
Single-wire/terminal point, solid AWG min.	24
Transmission medium	Copper
File format/coding	UART (11/10 bit switchable; NRZ), slip-tolerant
Data direction switching	Automatic control

Dimensions

Width	35 mm
Height	99 mm
Depth	105 mm

Material specifications

Material	PA 6.6-FR (Housing)
----------	---------------------

Cable / line

FO cable

Fiber types	980/1000 µm
	200/230 µm
	Polymer fiber
	PCF fiber

Environmental and real-life conditions

Ambient conditions

Degree of protection	IP20
Ambient temperature (operation)	-20 °C ... 60 °C
Ambient temperature (storage/transport)	-40 °C ... 85 °C
Altitude	≤ 5000 m (For restrictions, see the manufacturer's declaration for altitude operation)
	≤ 2000 m (Hazardous locations)
Permissible humidity (operation)	30 % ... 95 % (non-condensing)

Approval data

CE

Certificate	CE-compliant
-------------	--------------

ATEX

Identification	□ II 3 G Ex ec IIC T4 Gc
Certificate	UL 21 ATEX 2550X
Note	Please follow the special installation instructions in the documentation!

ATEX, FO interface

FO converters - PSI-MOS-RS485W2/FO 660 E



2708313

<https://www.phoenixcontact.com/pc/products/2708313>

Identification	<input type="checkbox"/> II (2) G [Ex op is Gb] IIC
	<input type="checkbox"/> II (2) D [Ex op is Db] IIIC
Certificate	PTB 06 ATEX 2042 U
Note	Please follow the special installation instructions in the documentation!

IECEX

Identification	Ex ec IIC T4 Gc
Certificate	IECEX ULD 21.00013X

UL, USA / Canada

Identification	Class I, Zone 2, AEx ec IIC T4 Gc
	Ex ec IIC T4 Gc X
	Class I, Div. 2, Groups A, B, C, D

Corrosive gas test

Identification	ISA-S71.04-1985 G3 Harsh Group A
----------------	----------------------------------

Shipbuilding

Identification	DNV GL
----------------	--------

DNV GL data

Temperature	B
Humidity	A
Vibration	A
EMC	B
Enclosure	Required protection according to the Rules shall be provided upon installation on board

EMC data

Electromagnetic compatibility	Conformance with EMC Directive 2014/30/EU
Noise emission	EN 55011
Noise immunity	EN 61000-6-2:2005

Electrostatic discharge

Standards/regulations	EN 61000-4-2
-----------------------	--------------

Electrostatic discharge

Contact discharge	± 6 kV
Discharge in air	± 8 kV
Comments	Criterion B

Electromagnetic HF field

Standards/regulations	EN 61000-4-3
-----------------------	--------------

Electromagnetic HF field

Field intensity	10 V/m
Comments	Criterion A

2708313

<https://www.phoenixcontact.com/pc/products/2708313>

Fast transients (burst)

Standards/regulations	EN 61000-4-4
-----------------------	--------------

Fast transients (burst)

Input	± 2 kV
Signal	± 2 kV
Comments	Criterion B

Surge current load (surge)

Standards/regulations	EN 61000-4-5
-----------------------	--------------

Surge current load (surge)

Input	± 0.5 kV
Signal	± 1 kV
Comments	Criterion B

Conducted interference

Standards/regulations	EN 61000-4-6
-----------------------	--------------

Conducted interference

Comments	Criterion A
Voltage	10 V

Emitted interference

Standards/regulations	EN 55011
Comments	Class A, industrial applications
Criterion A	Normal operating behavior within the specified limits.
Criterion B	Temporary impairment to operational behavior that is corrected by the device itself.

Standards and regulations

Free from substances that could impair the application of coating	in accordance with VW-AUDI-Seat central standard P-VW 3.10.7 57 65 0
---	--

Mounting

Mounting type	DIN rail mounting
---------------	-------------------

Drawings

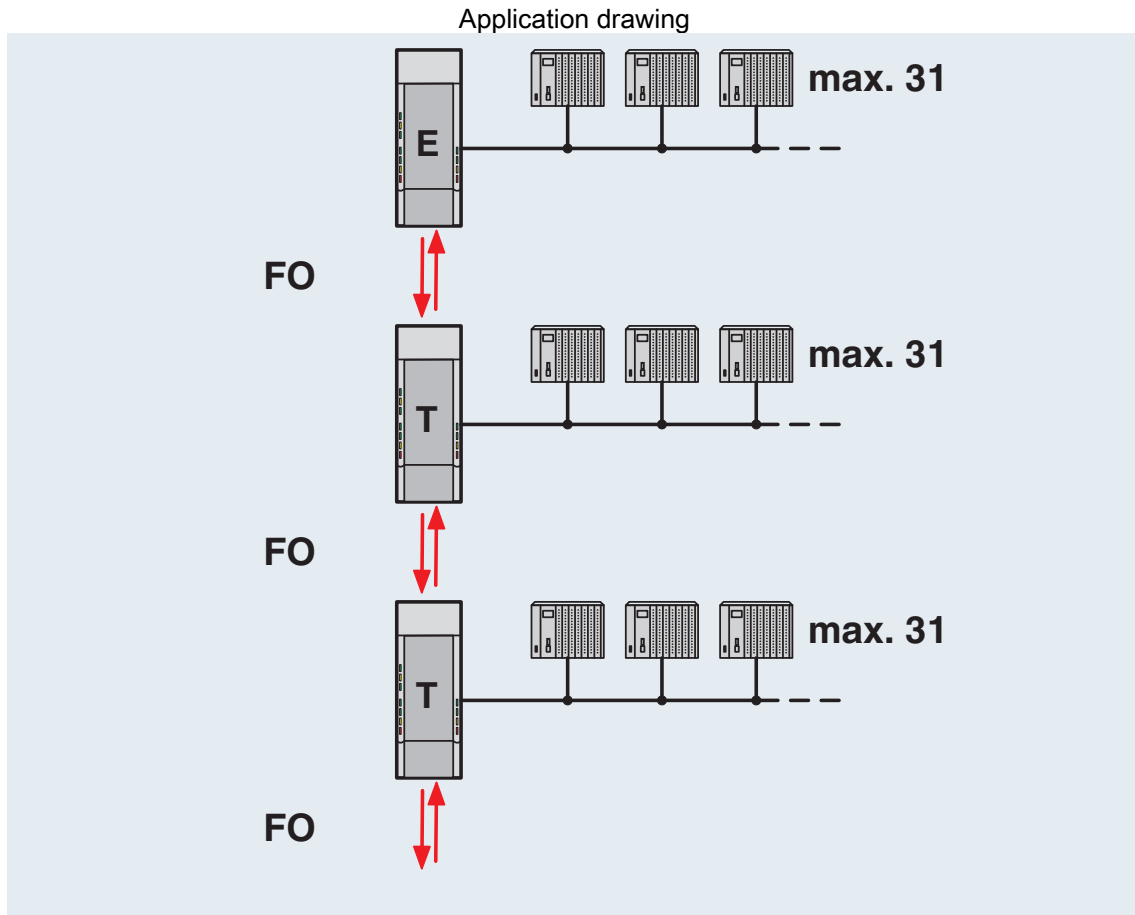

Line structure

2708313

<https://www.phoenixcontact.com/pc/products/2708313>

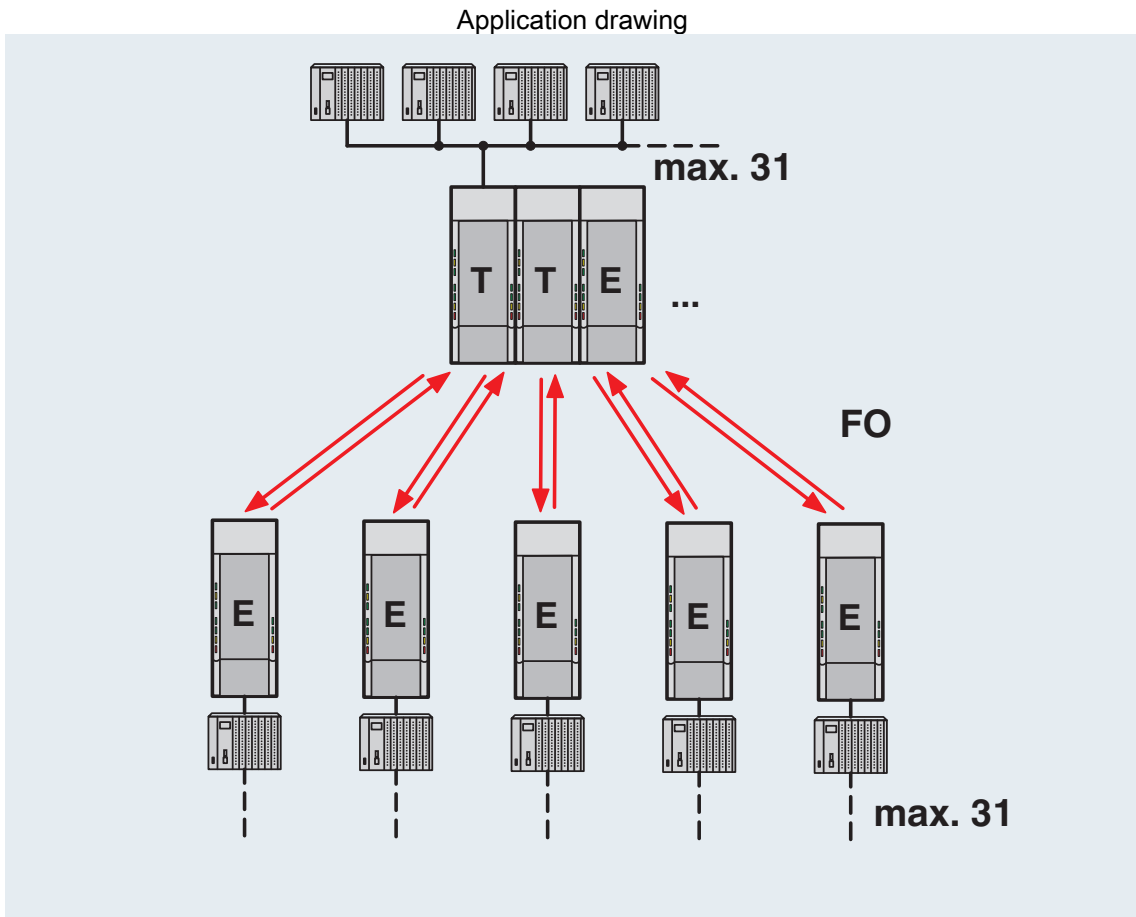

Star structure

FO converters - PSI-MOS-RS485W2/FO 660 E



2708313

<https://www.phoenixcontact.com/pc/products/2708313>

Schematic diagram

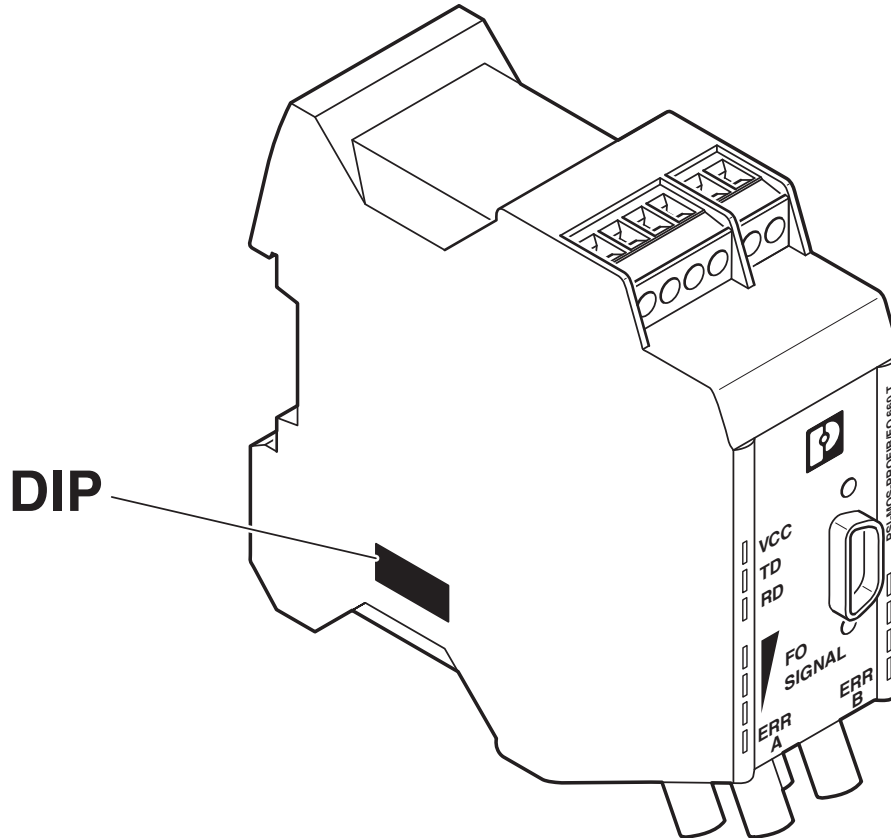

Position of DIP switches

Application drawing

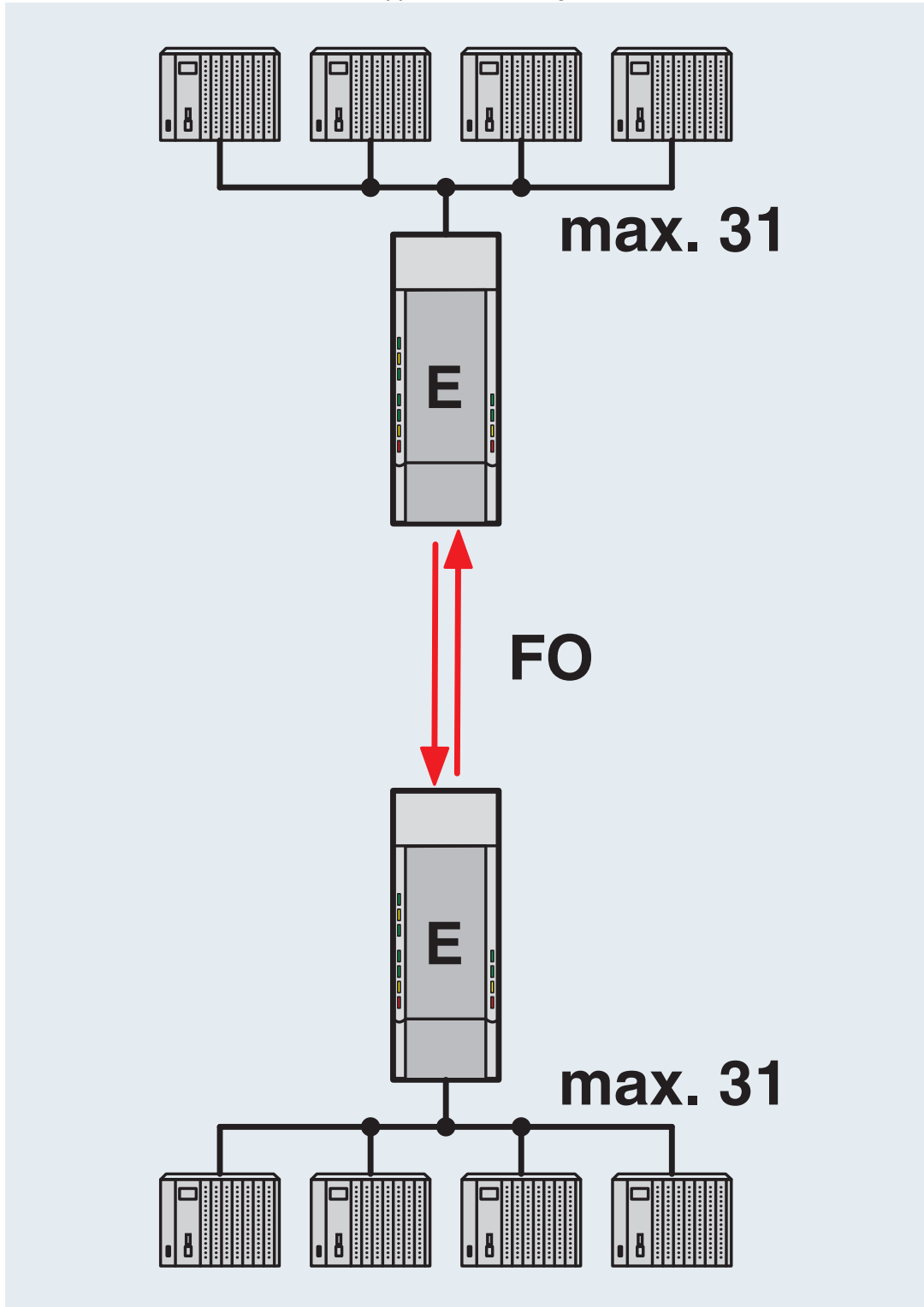

Point-to-point connection

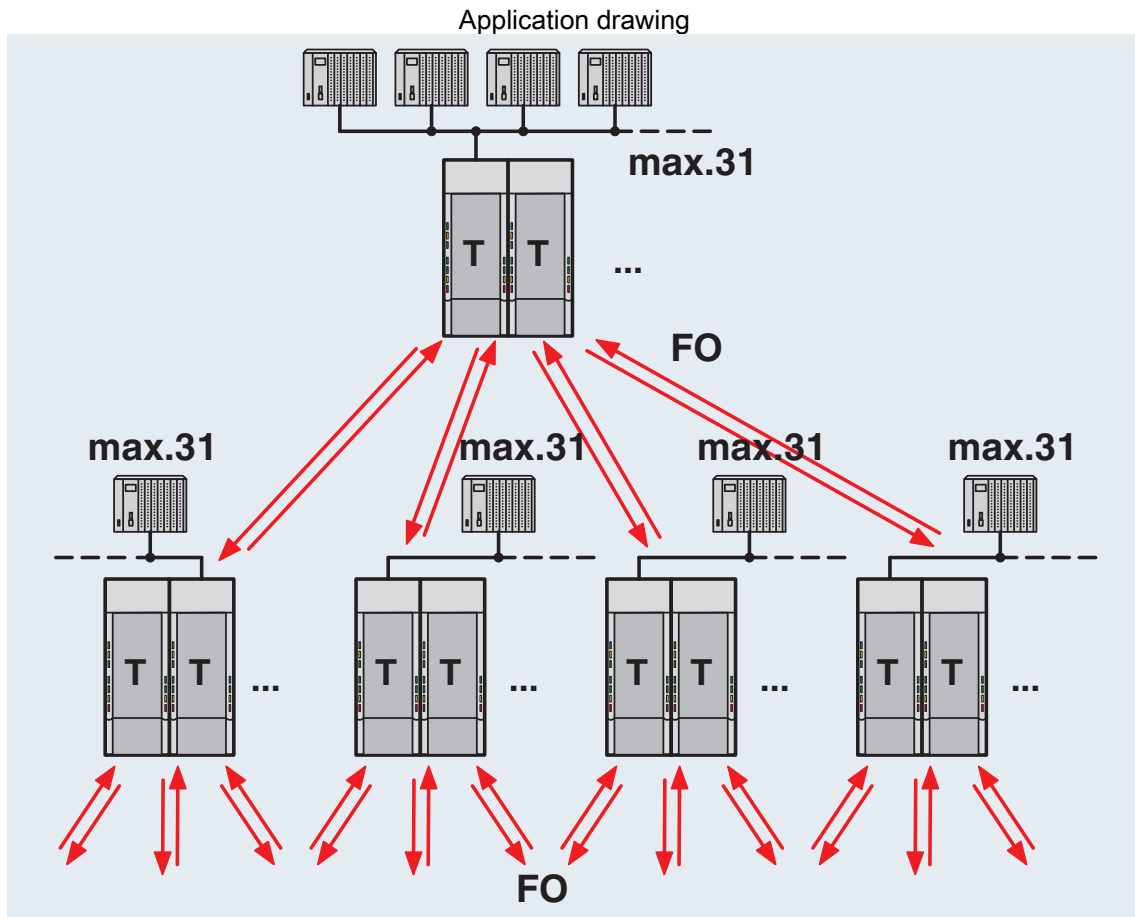

Tree structure

FO converters - PSI-MOS-RS485W2/FO 660 E



2708313

<https://www.phoenixcontact.com/pc/products/2708313>

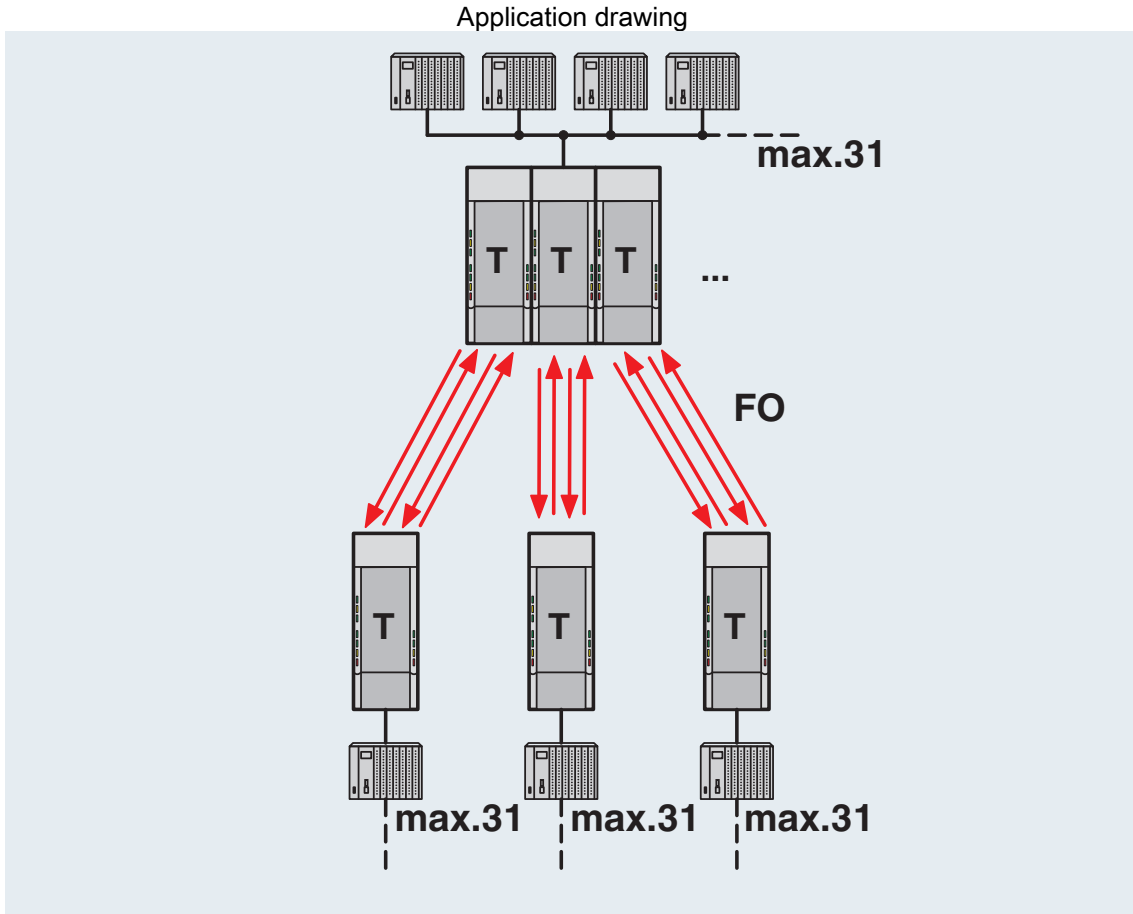

Redundant structure

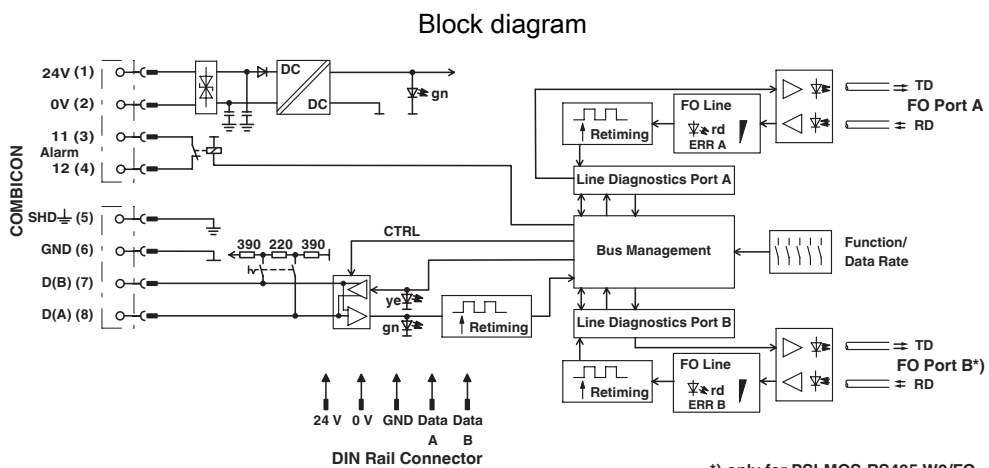

*) only with PSI-MOS.../FO...T

Application drawing

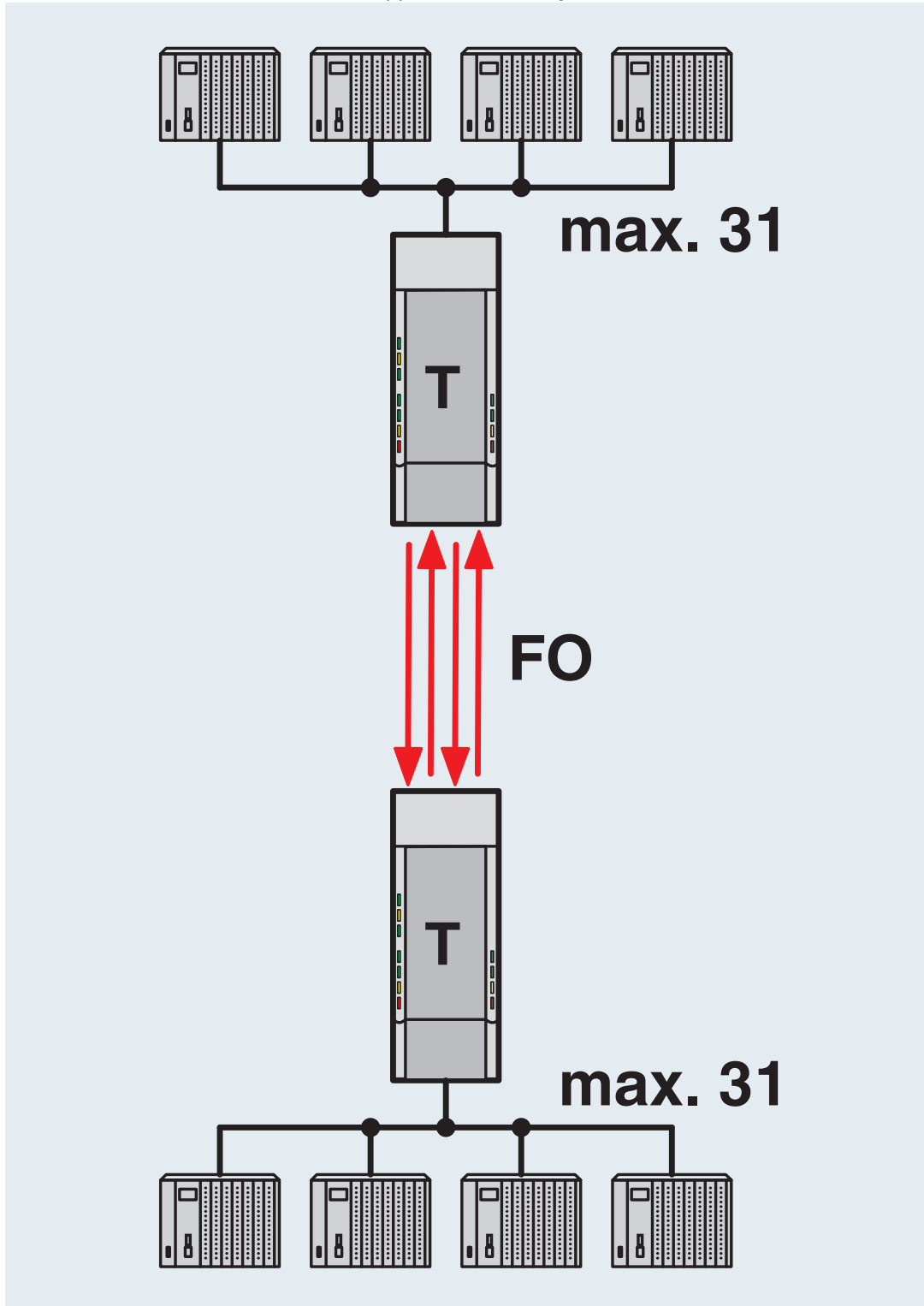

Redundant point-to-point connection

FO converters - PSI-MOS-RS485W2/FO 660 E



2708313

<https://www.phoenixcontact.com/pc/products/2708313>

Schematic diagram

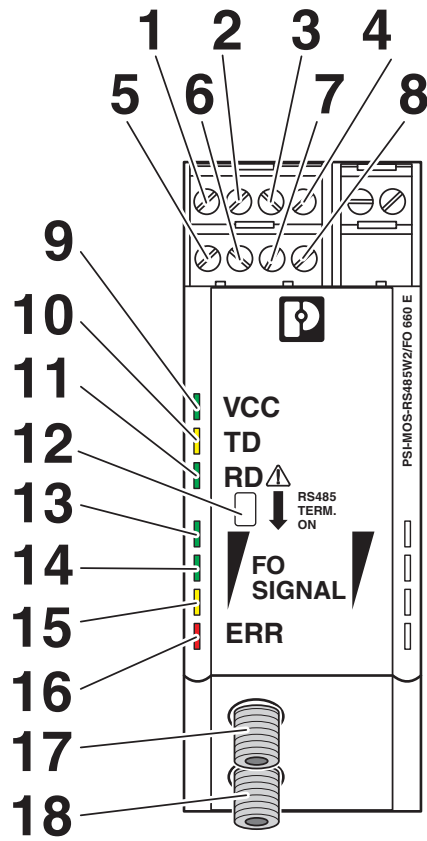

Front view

2708313

<https://www.phoenixcontact.com/pc/products/2708313>

Approvals

 **EAC**
Approval ID: RU *-DE.A*30.B.01735

 **DNV GL**
Approval ID: TAA00001KR

	Nominal Voltage U_N	Nominal Current I_N	Cross Section AWG	Cross Section mm^2
			-	-

 **UL Listed**
Approval ID: FILE E 238705

 **cUL Listed**
Approval ID: FILE E 238705

 **IECEx**
Approval ID: IECEx ULD 21.0013X

 **ATEX**
Approval ID: PTB 06 ATEX 2042U

	Nominal Voltage U_N	Nominal Current I_N	Cross Section AWG	Cross Section mm^2
			-	-

 **ATEX**
Approval ID: PxCIF06ATEX2708261X

 **cUL Listed**
Approval ID: FILE E 199827

 **UL Listed**
Approval ID: FILE E 199827

 **ATEX**
Approval ID: UL 21 ATEX 2550X

cULus Listed

FO converters - PSI-MOS-RS485W2/FO 660 E

2708313

<https://www.phoenixcontact.com/pc/products/2708313>



cULus Listed

FO converters - PSI-MOS-RS485W2/FO 660 E



2708313

<https://www.phoenixcontact.com/pc/products/2708313>

Classifications

ECLASS

ECLASS-9.0	19170114
ECLASS-10.0.1	19170132
ECLASS-11.0	19170411

ETIM

ETIM 8.0	EC001467
----------	----------

UNSPSC

UNSPSC 21.0	43201500
-------------	----------

FO converters - PSI-MOS-RS485W2/FO 660 E



2708313

<https://www.phoenixcontact.com/pc/products/2708313>

Environmental Product Compliance

China RoHS	Environmentally Friendly Use Period = 50 years For information on hazardous substances, refer to the manufacturer's declaration available under "Downloads"
------------	--

FO converters - PSI-MOS-RS485W2/FO 660 E



2708313

<https://www.phoenixcontact.com/pc/products/2708313>

Accessories

FO connectors

FO connectors - PSM-SET-FSMA/4-KT - 2799720

<https://www.phoenixcontact.com/pc/products/2799720>

F-SMA plug set for polymer fiber, for self assembly consisting of 4 quick mounting connectors with bend protection sleeve



FO connectors

FO connectors - PSM-SET-FSMA/4-HCS - 2799487

<https://www.phoenixcontact.com/pc/products/2799487>

F-SMA plug set for PCF fiber, for self assembly consisting of 4 quick mounting connectors with bend protection sleeve



FO converters - PSI-MOS-RS485W2/FO 660 E

2708313

<https://www.phoenixcontact.com/pc/products/2708313>

FO cable

FO cable - PSM-LWL-KDHEAVY-980/1000 - 2744319

<https://www.phoenixcontact.com/pc/products/2744319>

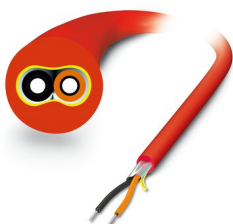

Polymer fiber cable, duplex 980 μm /1000 μm , medium-weight version for installation in stationary systems and machines, by the meter without male connector

FO cable

FO cable - PSM-LWL-RUGGED-980/1000 - 2744322

<https://www.phoenixcontact.com/pc/products/2744322>



Polymer fiber cable, duplex 980 μm /1000 μm , heavy-weight version for installation in stationary systems and machines, by the meter without male connector

2708313

<https://www.phoenixcontact.com/pc/products/2708313>

FO cable

FO cable - PSM-LWL-RUGGED-FLEX-980/1000 - 2744335

<https://www.phoenixcontact.com/pc/products/2744335>



Polymer fiber cable, duplex 980/1000 μm , heavy-weight, highly flexible version for flexible conduit applications, by the meter, without connector

FO cable

FO cable - PSM-LWL-HCS-RUGGED-200/230 - 2799885

<https://www.phoenixcontact.com/pc/products/2799885>

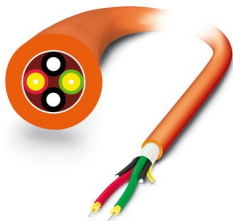

PCF cable, duplex 200 μm /230 μm , by the meter without male connector, for installation in stationary systems and machines

FO converters - PSI-MOS-RS485W2/FO 660 E

2708313

<https://www.phoenixcontact.com/pc/products/2708313>

FO cable

FO cable - PSM-LWL-HCSO-200/230 - 2799445

<https://www.phoenixcontact.com/pc/products/2799445>



PCF cable, duplex 200/230 μm , by the meter, without connector, for outdoor installation

Power supply unit

Power supply unit - QUINT4-SYS-PS/1AC/24DC/2.5/SC - 2904614

<https://www.phoenixcontact.com/pc/products/2904614>



Primary-switched power supply unit, QUINT POWER, Screw connection, DIN rail mounting, input: 1-phase, output: 24 V DC / 2.5 A

2708313

<https://www.phoenixcontact.com/pc/products/2708313>

DIN rail bus connectors

DIN rail bus connectors - ME 17,5 TBUS 1,5/ 5-ST-3,81 KMGY - 2713645

<https://www.phoenixcontact.com/pc/products/2713645>

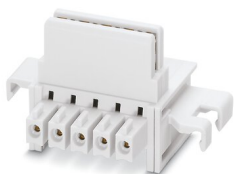

DIN rail connector, color: light grey, nominal current: 8 A (parallel contacts), rated voltage (III/2): 125 V, number of positions: 5, pitch: 3.81 mm, mounting: DIN rail mounting, locking: without, mounting: without, type of packaging: packed in cardboard, Item with gold-plated contacts, bus connectors for connecting with electronics housings, 5 parallel contacts

Assembly tool

Assembly tool - PSM-POF-KONFTOOL - 2744131

<https://www.phoenixcontact.com/pc/products/2744131>



Polymer fiber DIY case, consisting of: Stripping knife, stripping pliers, polishing wheels for F-SMA and SC-RJ quick mounting connectors, polishing pad and emery paper

FO converters - PSI-MOS-RS485W2/FO 660 E

2708313

<https://www.phoenixcontact.com/pc/products/2708313>

Assembly tool

Assembly tool - PSM-SET-FSMA-POLISH - 2799348

<https://www.phoenixcontact.com/pc/products/2799348>



Polymer fiber polishing set, for F-SMA quick mounting connectors

Measuring instrument

Measuring instrument - PSM-FO-POWERMETER - 2799539

<https://www.phoenixcontact.com/pc/products/2799539>



Fiber optic measuring case, consisting of an optical power meter, F-SMA, B-FOC adapters, reference fibers and operating instructions

FO converters - PSI-MOS-RS485W2/FO 660 E

2708313

<https://www.phoenixcontact.com/pc/products/2708313>

Fiber optic coupling

Fiber optic coupling - PSM-SET-FSMA-LINK/2 - 2799416

<https://www.phoenixcontact.com/pc/products/2799416>

Coupling; set consisting of 2 couplings for connecting F-SMA plugs



Screwdriver

Screwdriver - SZS 0,4X2,5 VDE - 1205037

<https://www.phoenixcontact.com/pc/products/1205037>

Screwdriver, slot-headed, VDE insulated, size: 0.4 x 2.5 x 80 mm, 2-component grip, with non-slip grip



FO converters - PSI-MOS-RS485W2/FO 660 E

2708313

<https://www.phoenixcontact.com/pc/products/2708313>

Stripping tool

Stripping tool - PSM-STRIP-FC/PROFIB - 2744623

<https://www.phoenixcontact.com/pc/products/2744623>

Quick stripping tool for PROFIBUS cable, type Fast Connect



Connection distributor

Connection distributor - PSM PTK - 2760623

<https://www.phoenixcontact.com/pc/products/2760623>

Passive RS-485 T-distributor, fitted with one 9-pin D-SUB pin strip and two 9-pin D-SUB socket strips

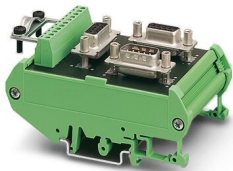

FO converters - PSI-MOS-RS485W2/FO 660 E

2708313

<https://www.phoenixcontact.com/pc/products/2708313>

Connection distributor

Connection distributor - PSM PTK-4 - 2799364

<https://www.phoenixcontact.com/pc/products/2799364>



Passive RS-485 T-distributor, fitted with one 9-pin D-SUB pin strip and five 9-pin D-SUB socket strips

Repeater

Repeater - PSI-REP-RS485W2 - 2313096

<https://www.phoenixcontact.com/pc/products/2313096>



Modular repeater for electrical isolation and range increase in RS-485 2-wire bus systems up to 500 kbps, 4-way isolation, rail-mountable, supply 24 V DC

2708313

<https://www.phoenixcontact.com/pc/products/2708313>

Repeater

Repeater - PSM-ME-RS485/RS485-P - 2744429

<https://www.phoenixcontact.com/pc/products/2744429>



Repeater, for potential separation and range increase in RS-485 2-wire bus systems, 3-way isolation, rail-mountable

Bus system cable

Bus system cable - PSM-CABLE-PROFIB/FC - 2744652

<https://www.phoenixcontact.com/pc/products/2744652>



By the meter, Bus system cable, PROFIBUS (12 Mbps), shielded, PVC FR VI/PVC, violet, 2-wire (1X2XAWG22/1), color single wire: Red, green, cable length: Free entry (1.0 ... 1000.0 m)

FO converters - PSI-MOS-RS485W2/FO 660 E

2708313

<https://www.phoenixcontact.com/pc/products/2708313>

D-SUB bus connector

D-SUB bus connector - SUBCON-PLUS M1 - 2761826

<https://www.phoenixcontact.com/pc/products/2761826>



D-SUB connector, 9-pos., male connector, two 35° cable entries, bus system: Modbus, Modbus Plus, BITBUS, ARCNET, MULT/MININET (B&R), SYSTEM 2003 (B&R), P-NET, pin assignment: 1, 2, 3, 5, 6, 8 to two screw connection terminal blocks

D-SUB bus connector

D-SUB bus connector - SUBCON-PLUS F1 - 2744267

<https://www.phoenixcontact.com/pc/products/2744267>



D-SUB connector, 9-pos. female connector, two 35° cable entries, bus system: Modbus, Modbus Plus, BITBUS, ARCNET, MULT/MININET (B&R), SYSTEM 2003 (B&R), P-NET, pin assignment: 1, 2, 3, 5, 6, 8; screw connection terminal blocks

FO converters - PSI-MOS-RS485W2/FO 660 E

2708313

<https://www.phoenixcontact.com/pc/products/2708313>

D-SUB bus connector

D-SUB bus connector - SUBCON-PLUS M2 - 2761839

<https://www.phoenixcontact.com/pc/products/2761839>



D-SUB connector, 9-pos., male connector, two 35° cable entries, bus system: CAN, SUCONET K1, K2 (MOELLER), S-BUS (Saia), J-BUS (Merlin Gerin), pin assignment: 2, 3, 4, 5, 7, 9 to two screw connection terminal blocks

D-SUB bus connector

D-SUB bus connector - SUBCON-PLUS F2 - 2799490

<https://www.phoenixcontact.com/pc/products/2799490>



D-SUB connector, 9-pos. female connector, two 35° cable entries, bus system: CAN, SUCONET K1, K2 (MOELLER), S-BUS (Saia), J-BUS (Merlin Gerin), pin assignment: 2, 3, 4, 5, 7, 9 to two screw connection terminal blocks

2708313

<https://www.phoenixcontact.com/pc/products/2708313>

D-SUB bus connector

D-SUB bus connector - SUBCON-PLUS 9/M - 2744018

<https://www.phoenixcontact.com/pc/products/2744018>



D-SUB connector, 9-pos., male connector, two 35° cable entries, universal type for all systems, pin assignment: 1, 2, 3, 4, 5, 6, 7, 8, 9 to one screw connection terminal block

D-SUB bus connector

D-SUB bus connector - SUBCON-PLUS 9/F - 2744241

<https://www.phoenixcontact.com/pc/products/2744241>



D-SUB connector, 9-pos. female connector, two 35° cable entries, universal type for all systems, pin assignment: 1, 2, 3, 4, 5, 6, 7, 8, 9 to one screw connection terminal block

FO converters - PSI-MOS-RS485W2/FO 660 E

2708313

<https://www.phoenixcontact.com/pc/products/2708313>

Termination resistor

Termination resistor - PSI-TERMINATOR-PB-TBUS - 2702636

<https://www.phoenixcontact.com/pc/products/2702636>



Active termination resistor for PROFIBUS and RS-485 bus systems, redundant power supply, routing of the supply voltage via DIN rail connector, electrical isolation, switchable termination, integrated programming interface

FO converters

FO converters - PSI-MOS-RS485W2/FO 660 T - 2708300

<https://www.phoenixcontact.com/pc/products/2708300>



FO converter with integrated optical diagnostics, alarm contact, for RS-485 2-wire bus systems (SUCONET K, Modbus ...) up to 500 kbps, NRZ coding, T-coupler with two FO interfaces (FSMA), 660 nm, for polymer/PCF fiber cable

2708313

<https://www.phoenixcontact.com/pc/products/2708313>

FO patch cable

FO patch cable - FOC-RUGGED-1012/IP20/... - 2901548

<https://www.phoenixcontact.com/pc/products/2901548>



Robust POF installation cable for assembly (IP20 heads only) for installation in stationary systems and machines with individual elements made of polyamide (PA), halogen-free, ozone and UV resistant, with reinforced polyurethane (PUR) outer sheath

FO patch cable

FO patch cable - FOC-RUGGED-FLEX-1013/IP20/... - 2901549

<https://www.phoenixcontact.com/pc/products/2901549>



Highly flexible POF round cable (IP20 heads only) for use in drag chains. Individual elements made from extremely wear-resistant polyamide (PA). The cable is halogen-free, ozone and UV resistant, and has a rugged polyurethane (PUR) outer sheath.

2708313

<https://www.phoenixcontact.com/pc/products/2708313>

FO patch cable

FO patch cable - FOC-KDHEAVY-1011/IP20/... - 2901553

<https://www.phoenixcontact.com/pc/products/2901553>

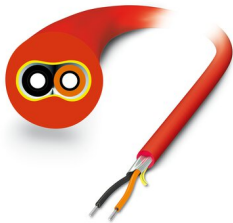

POF installation cable for assembly (IP20 heads only) for installation in stationary systems and machines with individual elements made of polyamide (PA), halogen-free, ozone and UV resistant, with a polyurethane (PUR) outer sheath

FO patch cable

FO patch cable - FOC-HCS-RUGGED-1014/IP20/... - 2901555

<https://www.phoenixcontact.com/pc/products/2901555>



Robust PCF installation cable for assembly (IP20 heads only) for installation in stationary systems and machines, aramid strain relief elements, with individual elements made from FRNC material, halogen-free, ozone and UV resistant, with a polyurethane (PUR) outer sheath

FO converters - PSI-MOS-RS485W2/FO 660 E



2708313

<https://www.phoenixcontact.com/pc/products/2708313>

FO patch cable

FO patch cable - FOC-HCS-RUGGED-1014/... - 1402191

<https://www.phoenixcontact.com/pc/products/1402191>

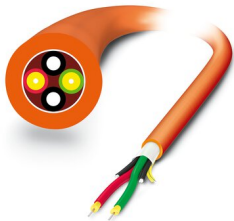

rugged PCF installation cable for inner areas with highly tear-proof aramid strain-relief elements. Individual elements made from highly flexible FRNC material. The cable is halogen-free, ozone and UV resistant and has a rugged polyurethane (PUR) outer sheath.

FO patch cable

FO patch cable - FOC-HCSO-1015/IP20/... - 2901557

<https://www.phoenixcontact.com/pc/products/2901557>



Highly rugged PCF round cable (IP20 heads only) for assembly and for outdoor installation with integrated moisture barrier as well as rodent-proof scrim. Individual elements made from highly flexible FRNC material. The wire is ozone and UV resistant with a very rugged polyethylene outer sheath.

Phoenix Contact 2022 © - all rights reserved
<https://www.phoenixcontact.com>

PHOENIX CONTACT GmbH & Co. KG
Flachsmarktstraße 8
D-32825 Blomberg
+49 (0) 5235-3 00
info@phoenixcontact.com