

# FO converters - PSI-MOS-RS485W2/FO1300 E



2708562

<https://www.phoenixcontact.com/pc/products/2708562>

Please be informed that the data shown in this PDF document is generated from our Online Catalog. Please find the complete data in the user documentation. Our General Terms of Use for Downloads are valid.



FO converter with integrated optical diagnostics, alarm contact, for RS-485 2-wire bus systems (SUCONET K, MODBUS ...) up to 500 kbps, NRZ coding, termination device with an FO interface (SC-Duplex), 1300 nm, for fiberglass cable

## Product Description

The **PSI-MOS-RS485W2/FO...** FO converters convert the electrical data signal into an optical one by protocol transparent means. The integrated optical diagnostics allow permanent monitoring of the FO paths during installation and also during operation. The floating switch contact is activated when the signal output on the fiber optic paths drops to a critical level. The **PSI-MOS-RS485W2/FO... E** termination devices convert an RS-485 interface to a fiber optic cable. They are ideal for point-to-point connections.

## Your advantages

- Connections can be plugged in via a COMBICON screw terminal block
- Supply voltage and data signals routed through the DIN rail connectors
- Can be combined with the PSI copper repeater in a modular way using DIN rail connectors
- Automatic data rate detection or fixed data rate setting via DIP switches
- Redundant power supply possible by means of optional system power supply unit
- High-quality electrical isolation between all interfaces (RS-485 // fiber optic ports // power supply // DIN rail connector)
- Approved for use in zone 2
- Floating switch contact for advance warning of critical FO paths
- Integrated optical diagnostics for continuous monitoring of FO paths
- Suitable for data rates up to 500 kbps

## Commercial Data

Item number	2708562
Packing unit	1 pc
Minimum order quantity	1 pc
Product Key	DNC212
Catalog Page	Page 435 (C-6-2019)
GTIN	4046356176279
Weight per Piece (including packing)	241.3 g
Weight per Piece (excluding packing)	241.3 g
Customs tariff number	85176200
Country of origin	DE

## Technical Data

### Notes

#### Utilization restriction

EMC note	EMC: class A product, see manufacturer's declaration in the download area
----------	---

#### Utilization restriction

CCCex note	Use in potentially explosive areas is not permitted in China.
------------	---

### Product properties

Product type	Media converter
MTTF	903 Years (SN 29500 standard, temperature 25°C, operating cycle 21%)
	412 Years (SN 29500 standard, temperature 40°C, operating cycle 34.25%)
	169 Years (SN 29500 standard, temperature 40°C, operating cycle 100%)
MTBF	484 Years (Telcordia standard, 25°C temperature, 21% operating cycle (5 days a week, 8 hours a day))
	102 Years (Telcordia standard, 40°C temperature, 34.25% operating cycle (5 days a week, 12 hours a day))

### Electrical properties

Electrical isolation	VCC // RS-485
Maximum power dissipation for nominal condition	1.375 W
Test voltage data interface/power supply	1.5 kV <sub>rms</sub> (50 Hz, 1 min.)

#### Supply

Supply voltage range	18 V DC ... 32 V DC
Nominal supply voltage	24 V DC (in acc. with UL)
Typical current consumption	55 mA (24 V DC)
Max. current consumption	90 mA
	≤ 2 A (For operation in a joining station, via the DIN rail connector)
Connection method	COMBICON plug-in screw terminal block

### Output data

#### Switching

Output name	Relay output
Output description	Alarm output
Number of outputs	1
Maximum switching voltage	60 V DC (Resistive Load, General Load)
	30 V AC (Resistive load)
	42 V AC (peak, resistive load)

# FO converters - PSI-MOS-RS485W2/FO1300 E



2708562

<https://www.phoenixcontact.com/pc/products/2708562>

Limiting continuous current	0.46 A
-----------------------------	--------

## Connection data

### Supply

Connection method	COMBICON plug-in screw terminal block
Stripping length	7 mm
Tightening torque	0.56 Nm ... 0.79 Nm

## Interfaces

Bit distortion, input	± 35 % (permitted)
Bit distortion, output	< 6.25 %
Signal	Modbus
	S-BUS
	Suconet K
	J-BUS
	DATA HIGHWAY

### Data: optical FO

No. of channels	1
Transmit capacity, minimum	-3.4 dBm (50/125 µm, multimode fiberglass)
	-4.7 dBm (62.5/125 µm, multimode fiberglass)
	-5.5 dBm (9/125 µm, singlemode fiberglass)
Transmission length incl. 3 dB system reserve	25 km (With F-G 50/125 0.7 dB/km at 1300 nm)
	22 km (with F-G 62.5/125 0.8 dB/km at 1300 nm)
	45 km (With F-E 9/125 0,4 dB/km at 1300 nm)
Transmission protocol	Protocol-transparent to the RS-485 interface
Connection method	SC duplex
Wavelength	1300 nm
Minimum receiver sensitivity	-25.5 dBm (50/125 µm)
	-25.5 dBm (62,5/125 µm)
	-26.5 dBm (9/125 µm)
Maximum receiver sensitivity	0 dBm (9/125 µm)
Transmission medium	Multi-mode fiberglass
	Single-mode fiberglass

### Data: RS-485 interface, 2-wire

Serial transmission speed	4.8/ 9.6/ 19.2/ 38.4/ 57.6/ 75/ 93.75/ 115.2/ 136/ 187.5/ 375/ 500 kbps
Connection method	Pluggable screw connection
Transmission length	≤ 1200 m (depending on the data rate, with shielded, twisted data cable)
Termination resistor	390 Ω (Can be connected)
	220 Ω
	390 Ω
Conductor cross section flexible max.	2.5 mm <sup>2</sup>

2708562

<https://www.phoenixcontact.com/pc/products/2708562>

Conductor cross section flexible min.	0.2 mm <sup>2</sup>
Conductor cross section solid max.	2.5 mm <sup>2</sup>
Conductor cross section solid min.	0.2 mm <sup>2</sup>
Max. AWG conductor cross section, flexible	14
Min. AWG conductor cross section, flexible	24
Single-wire/terminal point, solid AWG max.	14
Single-wire/terminal point, solid AWG min.	24
Transmission medium	Copper
File format/coding	UART (11/10 bit switchable; NRZ), slip-tolerant
Data direction switching	Automatic control

## Dimensions

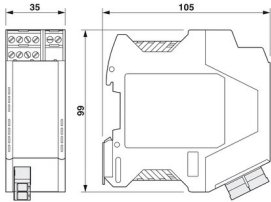
Dimensional drawing	
Width	35 mm
Height	99 mm
Depth	105 mm

## Material specifications

Material	PA 6.6-FR (Housing)
----------	---------------------

## Cable / line

### FO cable

Fiber types	50/125 μm
	9/125 μm
	Fiberglass

## Environmental and real-life conditions

### Ambient conditions

Degree of protection	IP20
Ambient temperature (operation)	-20 °C ... 60 °C
Ambient temperature (storage/transport)	-40 °C ... 85 °C
Altitude	≤ 5000 m (For restrictions, see the manufacturer's declaration for altitude operation)
	≤ 2000 m (Hazardous locations)
Permissible humidity (operation)	30 % ... 95 % (non-condensing)

## Approval data

CE

# FO converters - PSI-MOS-RS485W2/FO1300 E



2708562

<https://www.phoenixcontact.com/pc/products/2708562>

Certificate	CE-compliant
-------------	--------------

## ATEX

Identification	<input type="checkbox"/> II 3 G Ex ec IIC T4 Gc
Certificate	UL 21 ATEX 2550X
Note	Please follow the special installation instructions in the documentation!

## IECEX

Identification	Ex ec IIC T4 Gc
Certificate	IECEX ULD 21.00013X

## UL, USA / Canada

Identification	Class I, Zone 2, AEx ec IIC T4 Gc
	Ex ec IIC T4 Gc X
	Class I, Div. 2, Groups A, B, C, D

## Corrosive gas test

Identification	ISA-S71.04-1985 G3 Harsh Group A
----------------	----------------------------------

## EMC data

Electromagnetic compatibility	Conformance with EMC Directive 2014/30/EU
Noise emission	EN 55011
Noise immunity	EN 61000-6-2

## Electrostatic discharge

Standards/regulations	EN 61000-4-2
-----------------------	--------------

## Electrostatic discharge

Contact discharge	± 6 kV
Discharge in air	± 8 kV
Comments	Criterion B

## Electromagnetic HF field

Standards/regulations	EN 61000-4-3
-----------------------	--------------

## Electromagnetic HF field

Field intensity	10 V/m
Comments	Criterion A

## Fast transients (burst)

Standards/regulations	EN 61000-4-4
-----------------------	--------------

## Fast transients (burst)

Input	± 2 kV
Signal	± 2 kV
Comments	Criterion B

## Surge current load (surge)

# FO converters - PSI-MOS-RS485W2/FO1300 E



2708562

<https://www.phoenixcontact.com/pc/products/2708562>

Standards/regulations	EN 61000-4-5
-----------------------	--------------

## Surge current load (surge)

Input	± 0.5 kV
Signal	± 1 kV
Comments	Criterion B

## Conducted interference

Standards/regulations	EN 61000-4-6
-----------------------	--------------

## Conducted interference

Comments	Criterion A
Voltage	10 V

## Emitted interference

Standards/regulations	EN 55011
Comments	Class A, industrial applications
Criterion A	Normal operating behavior within the specified limits.
Criterion B	Temporary impairment to operational behavior that is corrected by the device itself.

## Standards and regulations

Free from substances that could impair the application of coating	in accordance with VW-AUDI-Seat central standard P-VW 3.10.7 57 65 0
---	--

## Mounting

Mounting type	DIN rail mounting
---------------	-------------------

## Drawings

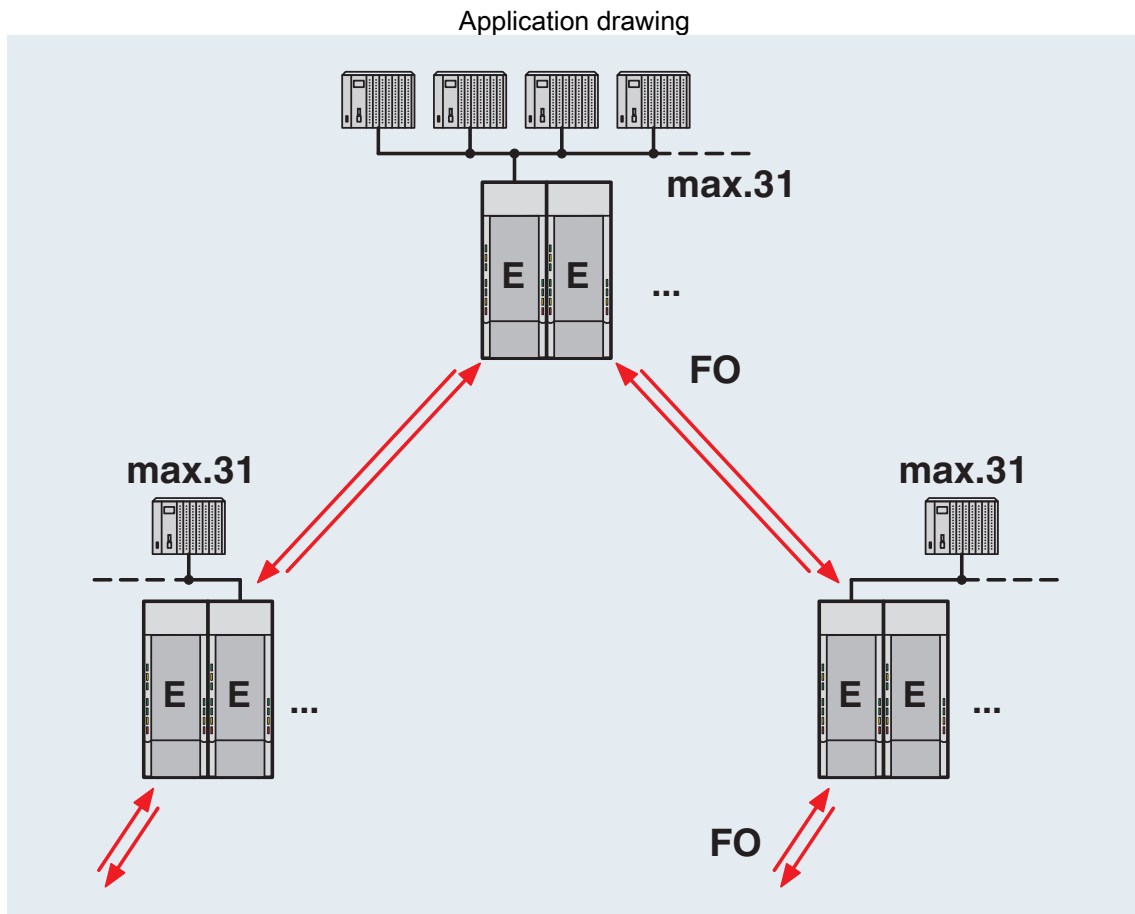

Tree structure

# FO converters - PSI-MOS-RS485W2/FO1300 E



2708562

<https://www.phoenixcontact.com/pc/products/2708562>

Schematic diagram

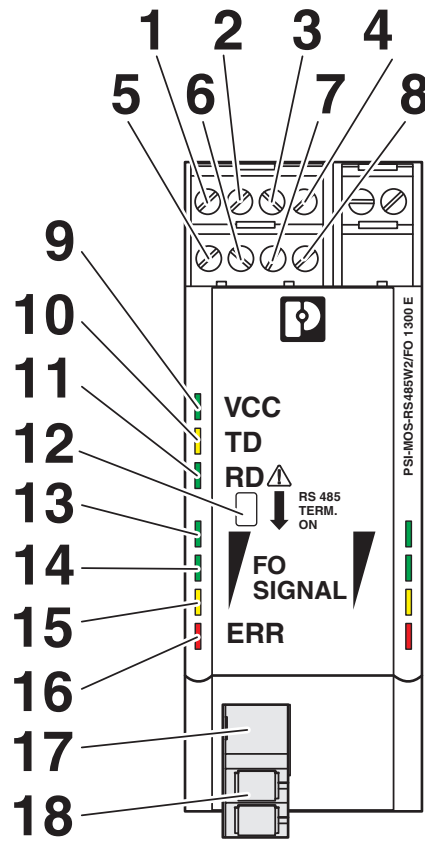

Front view



# FO converters - PSI-MOS-RS485W2/FO1300 E

2708562

<https://www.phoenixcontact.com/pc/products/2708562>

Schematic diagram

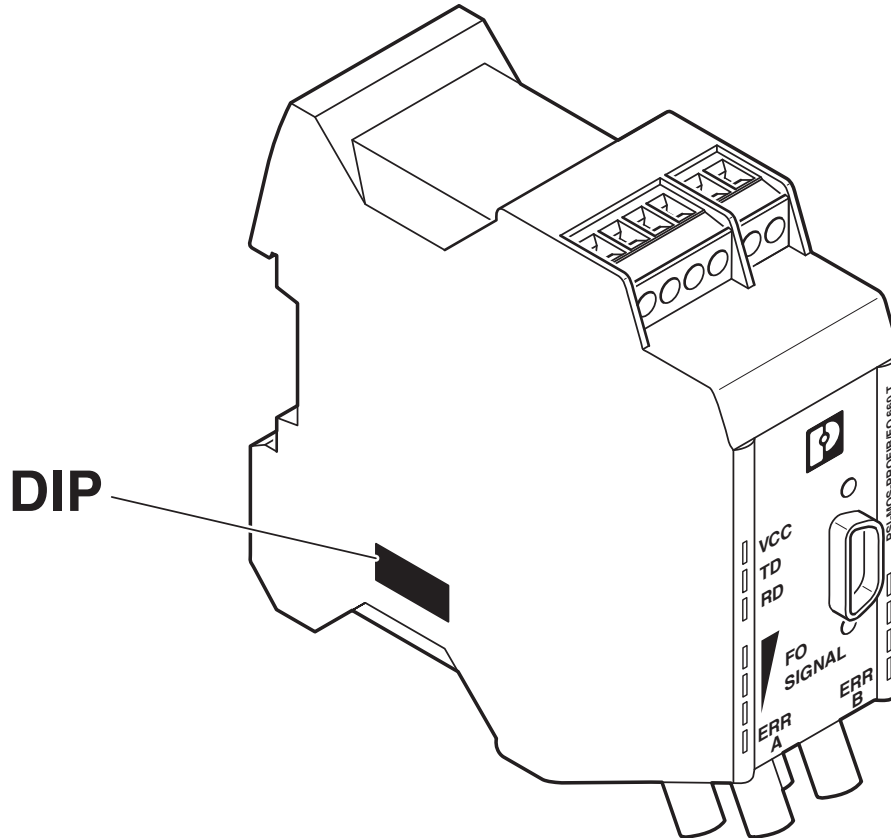

Position of DIP switches

2708562

<https://www.phoenixcontact.com/pc/products/2708562>

Application drawing

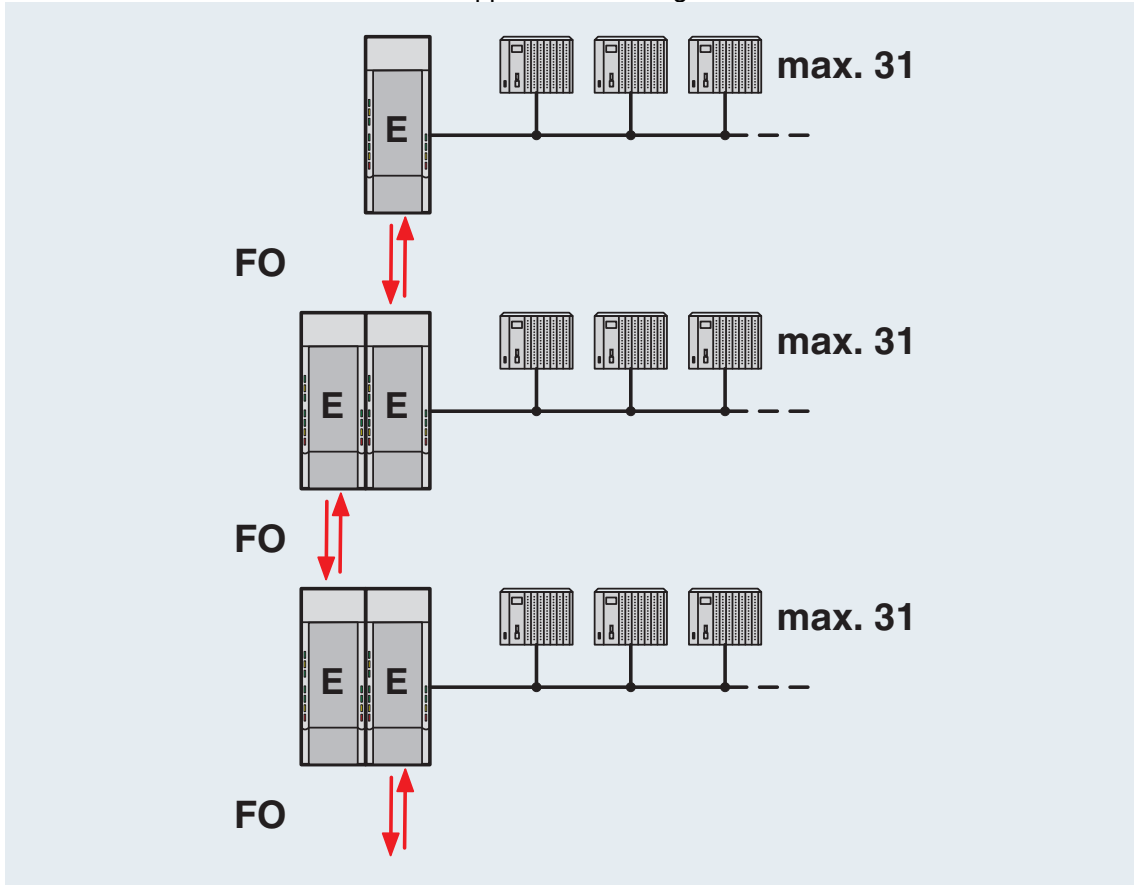

Line structure

Application drawing

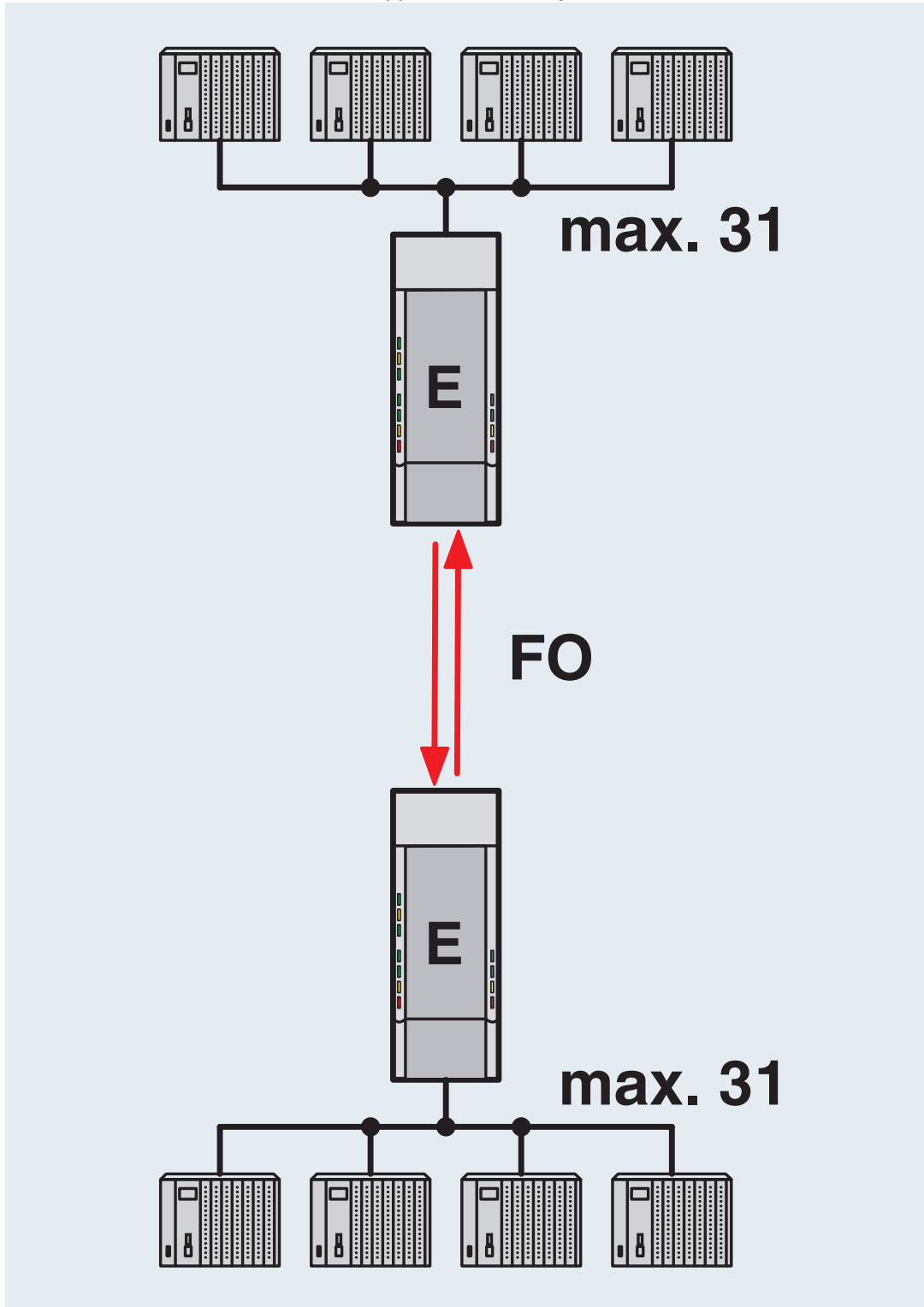

Point-to-point connection

# FO converters - PSI-MOS-RS485W2/FO1300 E



2708562

<https://www.phoenixcontact.com/pc/products/2708562>

Dimensional drawing

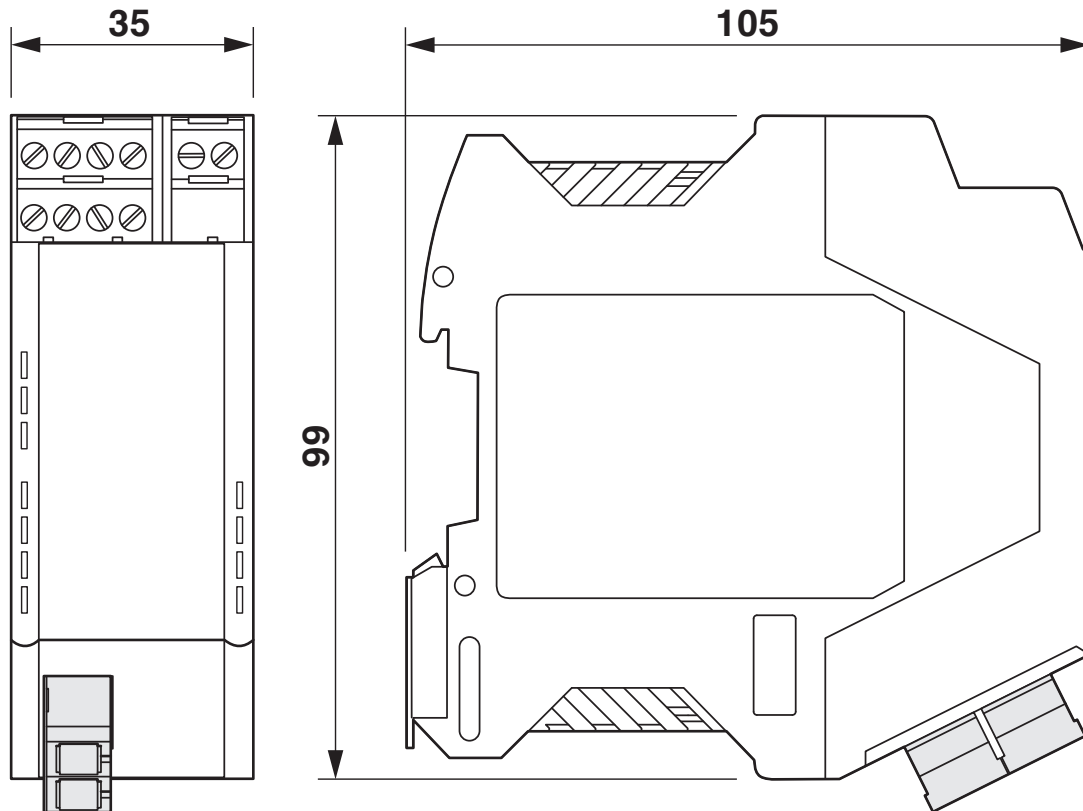

Housing dimensions

Block diagram

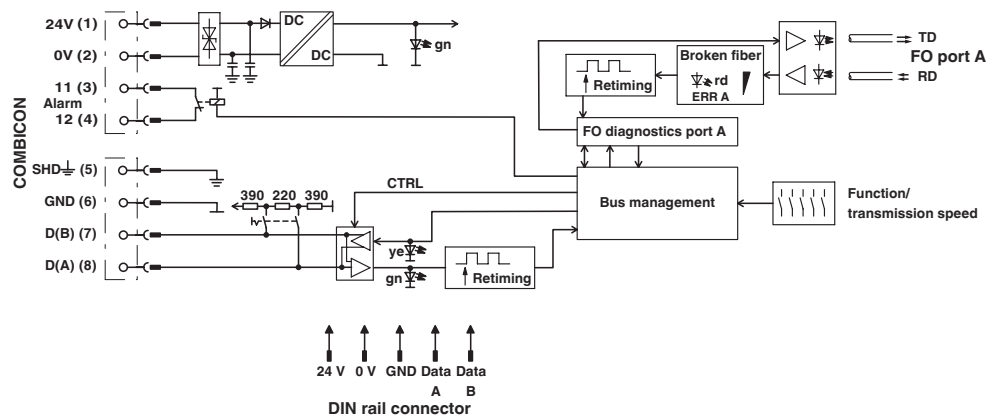

Basic circuit diagram

# FO converters - PSI-MOS-RS485W2/FO1300 E



2708562

<https://www.phoenixcontact.com/pc/products/2708562>

Application drawing

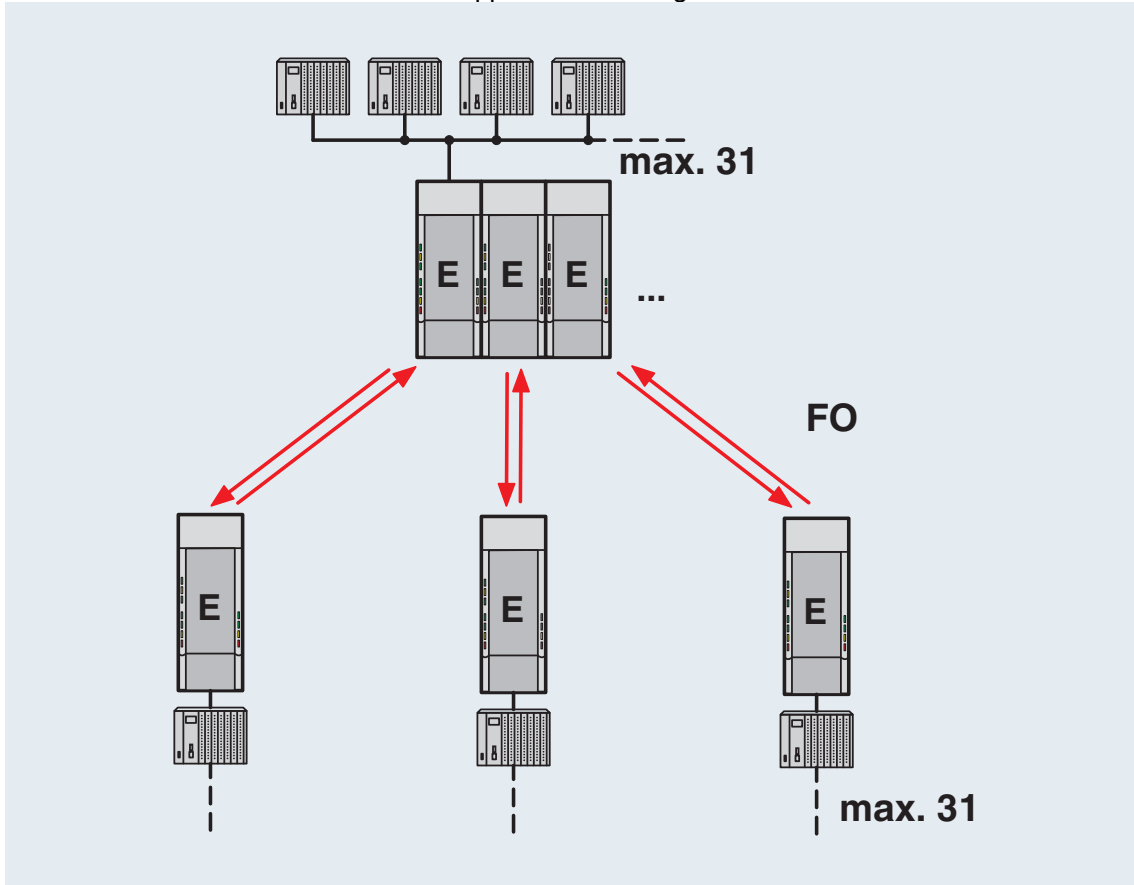

Star structure

2708562

<https://www.phoenixcontact.com/pc/products/2708562>

## Approvals



**EAC**

Approval ID: TR TS\_D\_01871-19



**UL Listed**

Approval ID: FILE E 238705



**cUL Listed**

Approval ID: FILE E 238705



**ATEX**

Approval ID: PxCIF07ATEX2708559X



**IECEx**

Approval ID: IECEx ULD 21.0013X



**cUL Listed**

Approval ID: FILE E 199827



**UL Listed**

Approval ID: FILE E 199827



**ATEX**

Approval ID: UL 21 ATEX 2550X

**cULus Listed**

**cULus Listed**

2708562

<https://www.phoenixcontact.com/pc/products/2708562>

## Classifications

### ECLASS

ECLASS-9.0	19170114
ECLASS-10.0.1	19170132
ECLASS-11.0	19170411

### ETIM

ETIM 8.0	EC001467
----------	----------

### UNSPSC

UNSPSC 21.0	43201500
-------------	----------

# FO converters - PSI-MOS-RS485W2/FO1300 E



2708562

<https://www.phoenixcontact.com/pc/products/2708562>

## Environmental Product Compliance

China RoHS	Environmentally Friendly Use Period = 50 years For information on hazardous substances, refer to the manufacturer's declaration available under "Downloads"
------------	--



# FO converters - PSI-MOS-RS485W2/FO1300 E



2708562

<https://www.phoenixcontact.com/pc/products/2708562>

## Accessories

### Power supply unit

Power supply unit - QUINT4-SYS-PS/1AC/24DC/2.5/SC - 2904614

<https://www.phoenixcontact.com/pc/products/2904614>



Primary-switched power supply unit, QUINT POWER, Screw connection, DIN rail mounting, input: 1-phase, output: 24 V DC / 2.5 A

---

### DIN rail bus connectors

DIN rail bus connectors - ME 17,5 TBUS 1,5/ 5-ST-3,81 KMGY - 2713645

<https://www.phoenixcontact.com/pc/products/2713645>



DIN rail connector, color: light grey, nominal current: 8 A (parallel contacts), rated voltage (III/2): 125 V, number of positions: 5, pitch: 3.81 mm, mounting: DIN rail mounting, locking: without, mounting: without, type of packaging: packed in cardboard, Item with gold-plated contacts, bus connectors for connecting with electronics housings, 5 parallel contacts

# FO converters - PSI-MOS-RS485W2/FO1300 E

2708562

<https://www.phoenixcontact.com/pc/products/2708562>

## FO patch cable

FO patch cable - FOC-LC:PA-SC:PA-OM2:D01/1 - 1115607

<https://www.phoenixcontact.com/pc/products/1115607>

Multi-mode OM2 duplex jumper, LC-SC, UPC polishing, length 1 m

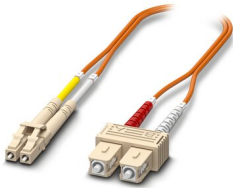

---

## FO patch cable

FO patch cable - FOC-LC:PA-SC:PA-OM2:D01/2 - 1115605

<https://www.phoenixcontact.com/pc/products/1115605>

Multi-mode OM2 duplex jumper, LC-SC, UPC polishing, length 2 m

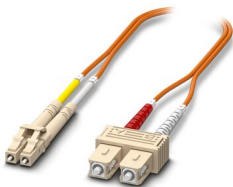

# FO converters - PSI-MOS-RS485W2/FO1300 E

2708562

<https://www.phoenixcontact.com/pc/products/2708562>

## FO patch cable

FO patch cable - FOC-SC:PA-SC:PA-OM2:D01/1 - 1115536

<https://www.phoenixcontact.com/pc/products/1115536>

Multi-mode OM2 duplex jumper, SC-SC, UPC polishing, length 1 m

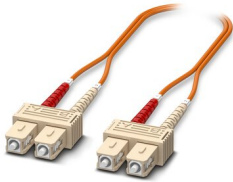

---

## FO patch cable

FO patch cable - FOC-SC:PA-SC:PA-OM2:D01/2 - 1115535

<https://www.phoenixcontact.com/pc/products/1115535>

Multi-mode OM2 duplex jumper, SC-SC, UPC polishing, length 2 m

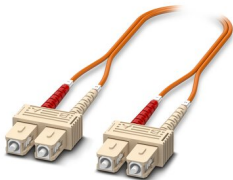

# FO converters - PSI-MOS-RS485W2/FO1300 E

2708562

<https://www.phoenixcontact.com/pc/products/2708562>

## FO patch cable

FO patch cable - FOC-ST:PA-SC:PA-OM2:D01/1 - 1115574

<https://www.phoenixcontact.com/pc/products/1115574>

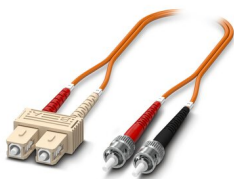

Multi-mode OM2 duplex jumper, ST-SC, UPC polishing, length 1 m

---

## FO patch cable

FO patch cable - FOC-ST:PA-SC:PA-OM2:D01/2 - 1115573

<https://www.phoenixcontact.com/pc/products/1115573>

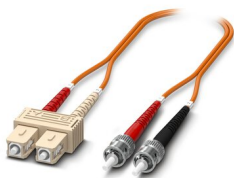

Multi-mode OM2 duplex jumper, ST-SC, UPC polishing, length 2 m

# FO converters - PSI-MOS-RS485W2/FO1300 E

2708562

<https://www.phoenixcontact.com/pc/products/2708562>

## FO patch cable

FO patch cable - FOC-LC:PA-SC:PA-OM4:D01/1 - 1115601

<https://www.phoenixcontact.com/pc/products/1115601>

Multi-mode OM4 duplex jumper, LC-SC, UPC polishing, length 1 m

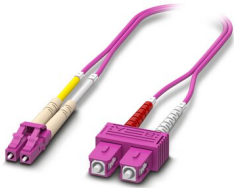

---

## FO patch cable

FO patch cable - FOC-LC:PA-SC:PA-OM4:D01/2 - 1115600

<https://www.phoenixcontact.com/pc/products/1115600>

Multi-mode OM4 duplex jumper, LC-SC, UPC polishing, length 2 m

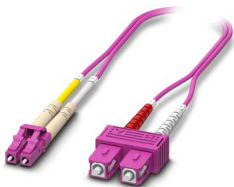

# FO converters - PSI-MOS-RS485W2/FO1300 E

2708562

<https://www.phoenixcontact.com/pc/products/2708562>

## FO patch cable

FO patch cable - FOC-SC:PA-SC:PA-OM4:D01/1 - 1115424

<https://www.phoenixcontact.com/pc/products/1115424>

Multi-mode OM4 duplex jumper, SC-SC, UPC polishing, length 1 m

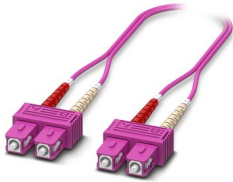

---

## FO patch cable

FO patch cable - FOC-SC:PA-SC:PA-OM4:D01/2 - 1115423

<https://www.phoenixcontact.com/pc/products/1115423>

Multi-mode OM4 duplex jumper, SC-SC, UPC polishing, length 2 m

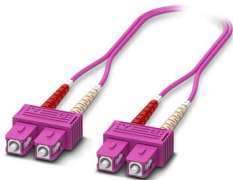

# FO converters - PSI-MOS-RS485W2/FO1300 E

2708562

<https://www.phoenixcontact.com/pc/products/2708562>

## FO patch cable

FO patch cable - FOC-SC:PA-SC:PA-OS2:D01/1 - 1115550

<https://www.phoenixcontact.com/pc/products/1115550>

Single-mode OS2 duplex jumper, SC-SC, UPC polishing, length 1 m

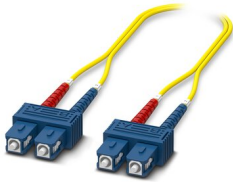

---

## FO patch cable

FO patch cable - FOC-SC:PA-SC:PA-OS2:D01/2 - 1115548

<https://www.phoenixcontact.com/pc/products/1115548>

Single-mode OS2 duplex jumper, SC-SC, UPC polishing, length 2 m

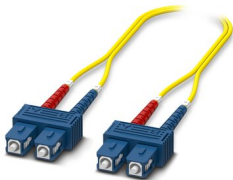

# FO converters - PSI-MOS-RS485W2/FO1300 E

2708562

<https://www.phoenixcontact.com/pc/products/2708562>

## FO patch cable

FO patch cable - FOC-ST:PA-SC:PA-OS2:D01/1 - 1115582

<https://www.phoenixcontact.com/pc/products/1115582>

Single-mode OS2 duplex jumper, ST-SC, UPC polishing, length 1 m

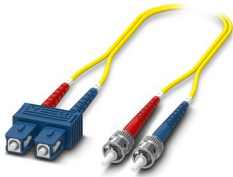

---

## FO patch cable

FO patch cable - FOC-ST:PA-SC:PA-OS2:D01/2 - 1115581

<https://www.phoenixcontact.com/pc/products/1115581>

Single-mode OS2 duplex jumper, ST-SC, UPC polishing, length 2 m

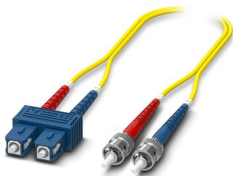



# FO converters - PSI-MOS-RS485W2/FO1300 E

2708562

<https://www.phoenixcontact.com/pc/products/2708562>

## FO patch cable

FO patch cable - FOC-LC:PA-SC:PA-OS2:D01/1 - 1115618

<https://www.phoenixcontact.com/pc/products/1115618>

Single-mode OS2 duplex jumper, LC-SC, UPC polishing, length 1 m

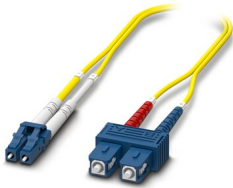

---

## FO patch cable

FO patch cable - FOC-LC:PA-SC:PA-OS2:D01/2 - 1115617

<https://www.phoenixcontact.com/pc/products/1115617>

Single-mode OS2 duplex jumper, LC-SC, UPC polishing, length 2 m

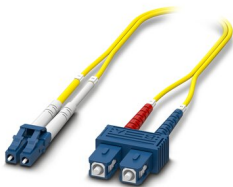

# FO converters - PSI-MOS-RS485W2/FO1300 E

2708562

<https://www.phoenixcontact.com/pc/products/2708562>

## FO patch cable

FO patch cable - FOC-GDM-RUGGED-1016/IP20/... - 2901558

<https://www.phoenixcontact.com/pc/products/2901558>



Robust GOF installation cable for assembly (IP20 heads only) for installation in stationary systems and machines, aramid strain-relief elements, with individual elements made from FRNC material, halogen-free, ozone and UV resistant, with a polyurethane (PUR) outer sheath

---

## FO patch cable

FO patch cable - FOC-GDO-1017/IP20/... - 2901559

<https://www.phoenixcontact.com/pc/products/2901559>



Highly rugged GOF round cable (IP20 heads only) for assembly and for outdoor installation with integrated moisture barrier as well as rodent-proof scrim. Individual elements made from highly flexible FRNC material. The wire is ozone and UV resistant with a very rugged polyethylene outer sheath.

# FO converters - PSI-MOS-RS485W2/FO1300 E

2708562

<https://www.phoenixcontact.com/pc/products/2708562>

## FO cable

FO cable - PSM-LWL-GDO- 50/125 - 2799432

<https://www.phoenixcontact.com/pc/products/2799432>



Fiberglass cable, duplex 50/125  $\mu\text{m}$ , by the meter, without connector, for outdoor installation

---

## FO cable

FO cable - PSM-LWL-GDM-RUGGED- 50/125 - 2799322

<https://www.phoenixcontact.com/pc/products/2799322>



Fiber glass cable, duplex 50  $\mu\text{m}$ /125  $\mu\text{m}$ , by the meter, without male connector, for installation in stationary systems and machines

# FO converters - PSI-MOS-RS485W2/FO1300 E

2708562

<https://www.phoenixcontact.com/pc/products/2708562>

## Termination resistor

Termination resistor - PSI-TERMINATOR-PB-TBUS - 2702636

<https://www.phoenixcontact.com/pc/products/2702636>



Active termination resistor for PROFIBUS and RS-485 bus systems, redundant power supply, routing of the supply voltage via DIN rail connector, electrical isolation, switchable termination, integrated programming interface

---

Phoenix Contact 2022 © - all rights reserved

<https://www.phoenixcontact.com>

PHOENIX CONTACT GmbH & Co. KG

Flachsmarktstraße 8

D-32825 Blomberg

+49 (0) 5235-3 00

[info@phoenixcontact.com](mailto:info@phoenixcontact.com)